The University of Warwick

NAME: **Adam T L Jones**

YEAR: **4**

INTAKE YEAR: **2013**

TYPE OF PROJECT: **CH962 Research Project**

TITLE: **The combinatorial discovery of antimicrobial polymers**

SUPERVISOR: **Dr Matthew I Gibson**

NUMBER OF WORDS: **8,203**

Abstract

The rise in antibiotic resistance among the world's bacteria population, combined with the diminishing reserve of effective drugs means that alternate methods of treatment need to be urgently investigated. In this study one potential alternative was investigated, that of cationic polymers. The focus is around the polymer poly(dimethylaminoethyl methacrylate) that was revealed in a previous study to be effective in antimicrobial testing.¹⁸ The major focus of this study was to have a polymer synthesis method that is able to be carried out in an automated system, enabling high throughput production and therefore permitting cationic polymers to be tested on an industrial scale. This is the only currently known method of reliably discovering new active compounds. Quantity has a quality all of its own.

Once sufficiently high throughput is achieved this method can then be used to identify new polymers that have antimicrobial activity comparable to that of currently available antibiotics. A breakthrough such as this could change the way that microbial infections are treated. This is due to the mechanism of action polymers take to destroy the cells. Due to the fact that this mechanism doesn't target specific proteins in the cells it will be much harder for resistance to occur. This means that if a polymer treatment is found it is possible that such a crisis of medicine will not be witnessed again.

Acknowledgements

This amazing project would not have been possible without the superb support of the Gibson Group of Warwick University.

A few special thanks go to;

Dr Sarah-Jane Richards who helped me out almost every day and was very patient with a guy who had very little laboratory experience. Thank you for never getting frustrated at any of my annoying questions or my one or two early laboratory confusions.

Professor Matthew Gibson who gave me this brilliantly interesting project, and who always had time to chat about any problems I had, and that, throughout the project, showed a continued and genuine interest in my work.

Abbreviations and Symbols

% - Percentage
DP_n - Degree of polymerisation
G - Gram
MMA – methyl methacrylate
PMMA – poly(methyl methacrylate)
DMAEMA – 2-(Dimethylamino)ethyl methacrylate
PDMAEMA - poly(dimethylaminoethyl methacrylate)
EMA – Ethyl methacrylate
PEMA Poly(Ethyl methacrylate)
i-BMA – isobutyl Methacrylate
P(iBMA) – poly(isobutyl Methacrylate)
CHMA – cyclohexyl methacrylate
PCHMA – poly(cyclohexyl methacrylate)
HEMA – Hydroxy ethyl methacrylate
PHEMA – poly(Hydroxy ethyl methacrylate)
DEGMEMA- di(ethylene glycol) methyl ether methacrylate
PDEGMEMA- poly(di(ethylene glycol) methyl ether methacrylate)
PEGMEMA- poly(ethylene glycol methyl ether) methacrylate
PPEGMEMA – poly(poly(ethylene glycol methyl ether) methacrylate)
PPGMA - poly(propylene glycol) methacrylate
PPPGMA – poly(poly(propylene glycol) methacrylate)
mg – Miligram
mL – Mililitre
NMR – Nuclear Magnetic Resonance
PBS – Phosphate Buffered Saline
SEC – Size Exclusion Chromatography
μL – microliter
LB - Lysogeny broth
DMSO – Dimethyl sulfoxide
TEOA – Triethanolamine

Table of Contents

Abstract
Acknowledgements
Table of contents

1. Introduction

1.1 antibiotics: the struggle against resistance
1.2 Cationic polymers – a possible answer
1.3 The problem of viable testing
1.4 Aims and objectives

2. Experimental

2.1 Materials
2.2 Analytical Methods
2.3 Instrumental methods
2.4 Synthetic Methods
- 2.4.1 Poly(dimethylaminoethyl methacrylate) synthesis of the 3 x 3 experiment
- 2.4.2 Poly(dimethylaminoethyl methacrylate) synthesis of 60 polymer plate
- 2.4.3 Poly(methyl methacrylate) synthesis of the 3 x 3 experiment
- 2.4.4 Poly(methyl methacrylate) synthesis of 60 polymer plate
2.5 Synthesis of copolymer library
2.6 Biological methods
- 2.6.1 Bacterial strains
- 2.6.2 Antimicrobial testing
- 2.6.3 Resazurin
- 2.6.4 further antimicrobial testing

3. Results and Discussion

3.1 DMAEMA polymerisation
3.2 HEMA and MMA polymerisation
3.3 Copolymerisation reaction and plate layout
3.4 Antimicrobial testing

4. Conclusions and Future work

4.1 Conclusions
- 4.1.2 Making a copolymer library
- 4.1.3 discovering a copolymer with a lower MIC value than that of PDMAEMA
- 4.1.4 the creation of a high throughput polymer process
4.2 Future Work

5. References

1. Introduction

1.1 Antibiotics: the struggle against resistance

The discovery of antibiotics in 1928 changed the face of modern medicine. Especially in the developed world where it led to the virtual elimination of many diseases such as tuberculosis. However, due to the ease of access and their obvious effectiveness antibiotics became a victim of their own success. Following the successful mass production antibiotics were almost instantly over proscribed. Also, due to the limited understanding of diseases at the time, antibiotics were also used to treat any illness, often in cases where the antibiotic was ineffective. This careless and often unnecessary overuse led to the development of resistance which was first noticed in the early 1950s, with the rise of penicillin resistance.¹ Fast forward to today and many of the favoured antibiotic groups have global resistance of above 25% (see figure 1).²

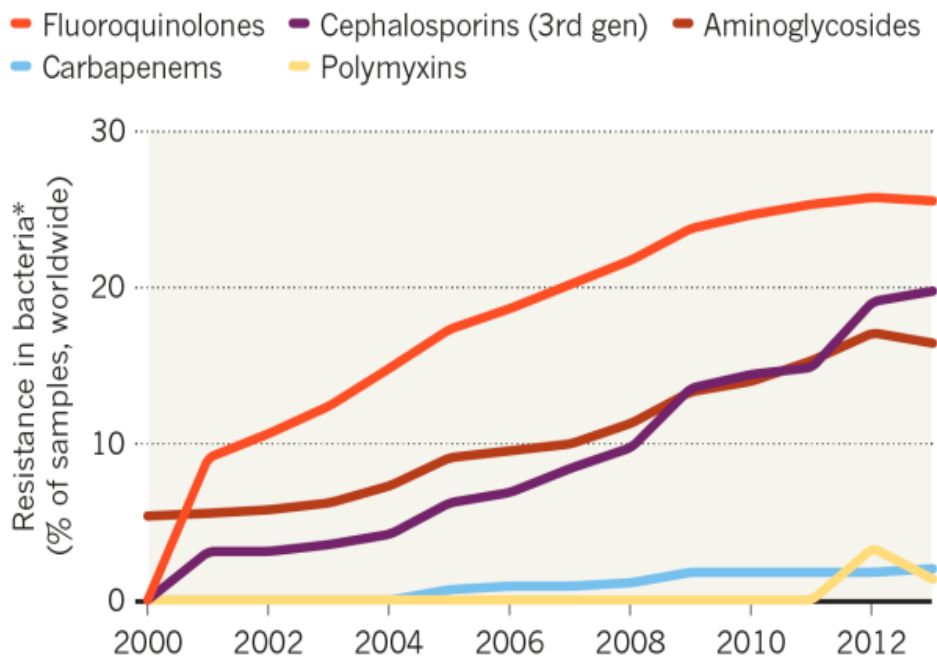

Figure 1-graph showing the increase in resistance of global bacteria samples to major families of antibiotics.¹

These antibiotics are favoured due to their effectiveness and lesser side effects. As resistance increases more toxic antibiotics are being prescribed in desperation as the medical profession stare over the abyss. Inevitably nature has adapted and we have already witnessed the evolution of a number of superbugs, bacteria that are resistant to many current antibiotic treatments.

The great concern is that new antibiotics are being made to meet this challenge. No new classes of antibiotics have been found since 1987 and the production of new antibiotics in the current classes has been falling since then (see figure 2).

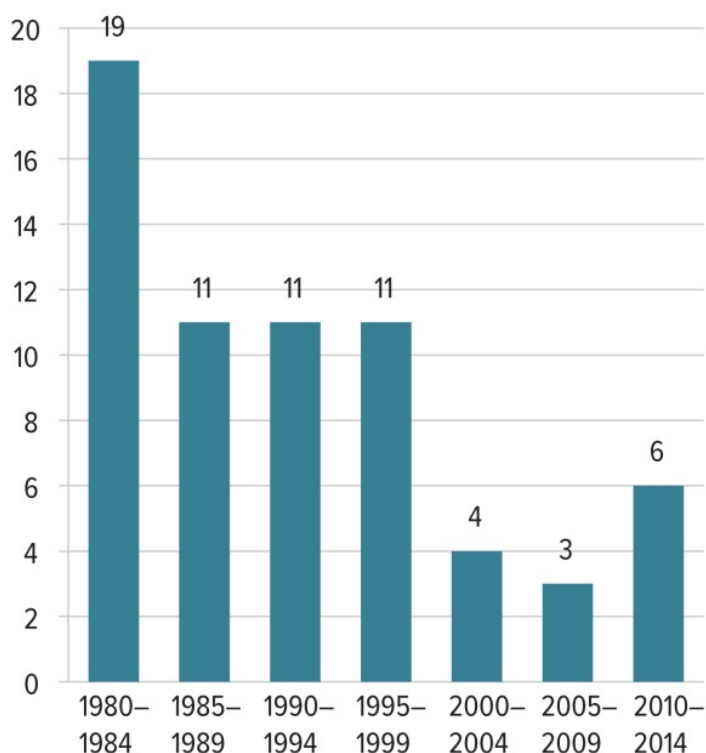

Figure 2- showing the steadily decreases discovery on new antibiotics.²

This leads to the conclusion that, as antibiotics are becoming more and more ineffective at an increasing rate the dangers of serious pandemic a real. While the danger of overuse is clear and well known, this knowledge has not lead to a decrease in the frequency with which it is used. While this is primarily a medical problem a significant side effect is economic. It is now estimated that as much as 50% of all antibiotic prescriptions in the US each year are being incorrectly prescribed to patients.³ Predications of the total cost of this trend are hard to accurately gauge however, the direct costs in medical bills alone are in the range of \$20 to [\$25] billion a year; while costs relating to loss of productivity have been estimated at as much as \$35 billion a year.³

1.2 Cationic polymers: a possible answer

Due to the very real fear of antibiotics becoming redundant in the near future other avenues have been energetically investigated. One of the more promising of these is that of antimicrobial cationic polymers. These were initially modelled after the naturally occurring peptides used in many living organism's immune systems, but more synthetic options are now also being researched. These polymers are described as cationic due to the fact that almost all bacterial cell walls are negatively charged and therefore their cationic nature increases adsorption to the bacterial surface. The negative charge of bacteria cell walls is known due to bacteria's susceptibility to electrophoresis. Owing to the availability of different cationic

monomer units and the fact that they are widely commercially available this gives credence to the concept.

As of today, the generally accepted mechanism of action for cationic antimicrobial polymers is that after adsorption occurs the polymer can then diffuse in through the cell wall. This then leads to a disruption of the cytoplasmic membrane, after which the contents of the cell leak out resulting in cell death. The fact that this mechanism doesn't have a single protein target means that it will be harder for the bacteria to develop resistance. Many papers also claim that increasing the hydrophobicity of the polymers increases their antimicrobial activity. This is theorised due to the fact that bacteria, more specifically the cytoplasmic membrane, is hydrophobic. The theory being that increasing hydrophobicity increases the ability of the polymer to interact with this membrane improving its efficiency.⁴

This provides a problem however due to the fact that our own mammalian cells are also susceptible to polymers with increased hydrophobicity. Each paper that mentions increasing hydrophobicity also mentions that, while it does improve performance against microbes, high enough hydrophobicity unfortunately also causes damage and death to mammalian cells. This therefore means that a balance needs to be struck, ensuring that the polymers stay selective and only kill pathogens rather than target our own cells.⁵

It is thought that further customisation of the polymer is possible, with some papers claiming that, due to difference in protein channels in mammalian and bacterial cells, if certain chemical groups are used it will increase binding to the chosen channel increasing specificity and lessen the risk to human cells.^{4,5,6} The worry here is that if you get too specific in regard to the polymers it will be just as easy for the bacteria to become resistant as they are to current treatments. This raises the concerning prospect that it will be simply a stop-gap measure and not the permanent answer which is universally desired.^{4,6}

1.3 The problem of viable testing

The idea of polymers being the answer to the rise in antimicrobial resistance is an idea that has been extensively researched and reported on in numerous papers. A very small sample of these papers are shown below.

Polymer	Target	Reference	Number of monomers investigated
dimethylaminoethyl methacrylate, dimethylaminoethyl acrylate and aminoethyl acrylate	<i>P. putida</i> , <i>E. coli</i> and <i>M. smegmatis</i> .	sj	3
Poly(sulfobetaine methacrylate)	<i>Pseudomonas aeruginosa</i> , <i>Staphylococcus epidermidis</i>	7	1
Poly[3-dimethyl (methacryloyloxyethyl) ammonium propane sulfonate-b-2-(diisopropylamino) ethyl methacrylate]	<i>Staphylococcus aureus</i>	8	1
Poly(2-methyl-2-oxazoline)	<i>Escherichia coli</i>	9	1
Nisin-immobilized organosilicon	<i>Bacillus subtilis</i>	10	2
Poly(n,n-diethylethylendiamine-coyrosol-based acrylic)	Poly(n,n-diethylethylendiamine-coyrosol-based acrylic)	11	2
pDEAEA and pMEA	<i>A. baumannii</i> , <i>S. aureus</i> , <i>P. aeruginosa</i> , and <i>K. pneumoniae</i>	12	3

Table 1- a small sample showing the issue that polymers have not, as of yet, been able to be investigated in large numbers.

While it is a very small sample it does show the major limiting factor in this research field, i.e. the testing methodology itself.

When pharmaceutical companies test for new drugs at the first step they screen out thousands of potential drugs via automated analysis. From this they then select the few successful samples, if any are present, for further testing. This is a tried and tested method proving that for drug discovery high-throughput testing is the best method currently available. The main way this is achieved in the drug discovery field is by having all the samples pre-loaded into multi well plates.

While cationic polymers may offer an answer to the rise in microbial resistance, at present papers investigating these polymers have been limited to 3 or 4 monomers at most (refer to table 1). This is a fraction of the amount that would, statistically speaking, need to be tested to find successful samples. Therefore, with the current polymerisation techniques and testing methods it will be a slow and arduous process to discover any useful polymers.

In order to give this research the chance of success, beyond that of mere scientific curiosity, the synthesis of cationic polymers needs to be made into a high throughput process. The ultimate goal of which would be to have a technique that could be fully, or at least highly, automated.

The major hurdle to this goal is that of having a polymerisation reaction that doesn't stop on contact with air. Air, specifically the oxygen contained within it, causes polymer chains to be oxidised, stopping the reaction in its tracks. This is normally dealt with by a time-consuming method of degassing the experimental mixture before the initiator is added. This is a major limiting factor, due to the time invested. It also means that having an automated system which, unless somehow extensively (not to mention expensively) degassed, would not work. Therefore, for simplicities sake, any polymerisation reaction that has the goal of being high-throughput would first need to be oxygen tolerant.

Oxygen tolerance of polymerisation reactions has been achieved through two major pathways, one route was reported by Yagci and co-workers where they used enzymes to remove the oxygen from solution before the reaction takes place.¹⁶ However, the main problem with this approach was caused by the high molecular weight of enzymes. Since the main way of separating polymers and purifying them is by molecular weight it becomes difficult to filter the enzymes out. Furthermore, enzymes require precise environments, limiting the reaction types they can be used in. Another way of oxygen removal is the use of metal ions as reducing agents, usually in the form of a catalytic system. Metal catalysts however present the risk of contamination, with metal ions being toxic, and also hard to filter out due to their tendency to chelate and form complexes.^{14, 15}

A new deoxygenation technique by Q. Fu and Co of Melbourne University provides another pathway.¹⁷ The group used the knowledge that trithiocarbonates (TTC) can be photo-activated to enable a RAFT polymerisation reaction to occur under relatively benign conditions (RTP), coupled with the fact that tertiary amines make good photo electron donors to invent this new synthesis. Using these ideas the group proved that, a TTC-RAFT agent, when in the presence of a sacrificial tertiary amine group can make a reaction tolerant to the presence of oxygen.

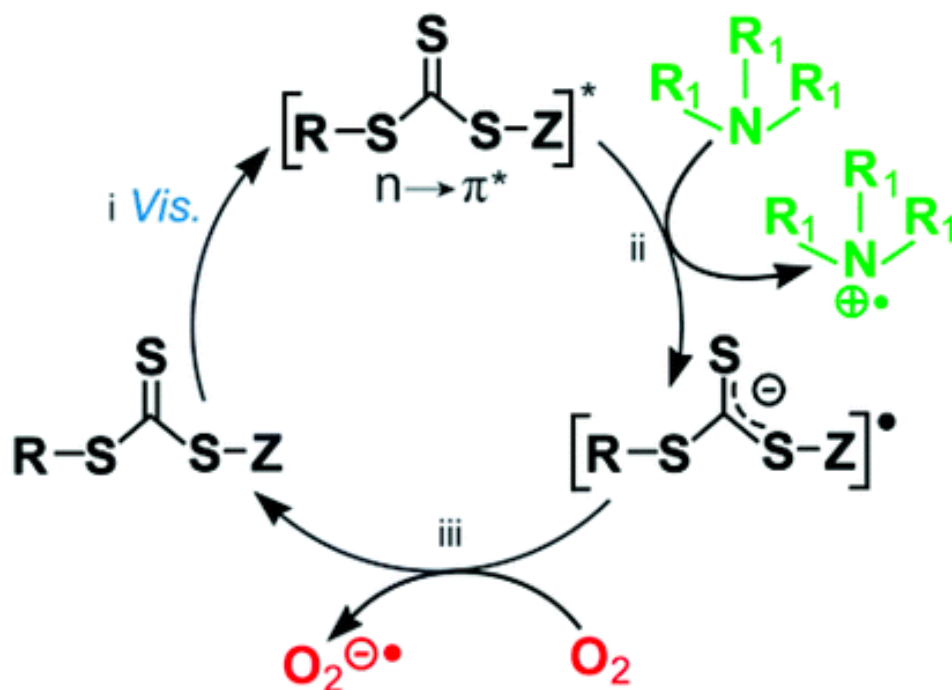

Scheme 1 – showing the proposed cycle for the deoxygenation that the TTC and tertiary amine provide.¹⁷

This tolerance is believed to occur by the photo-excited TTC acting as an electron shuttle between the tertiary amine and the dissolved molecular oxygen. This causes the oxygen to be reduced making it harmless to the reaction (see scheme 1). After this, and due to the TTC not being used up in the oxygen removal step the reaction can then proceed via normal RAFT polymerisation (can be seen in figure 2). The fact that this reaction can occur in the presence of oxygen, at room temperature, and that the only initiator needed is blue light, makes this reaction perfect for modifying for a high-throughput and automated system.

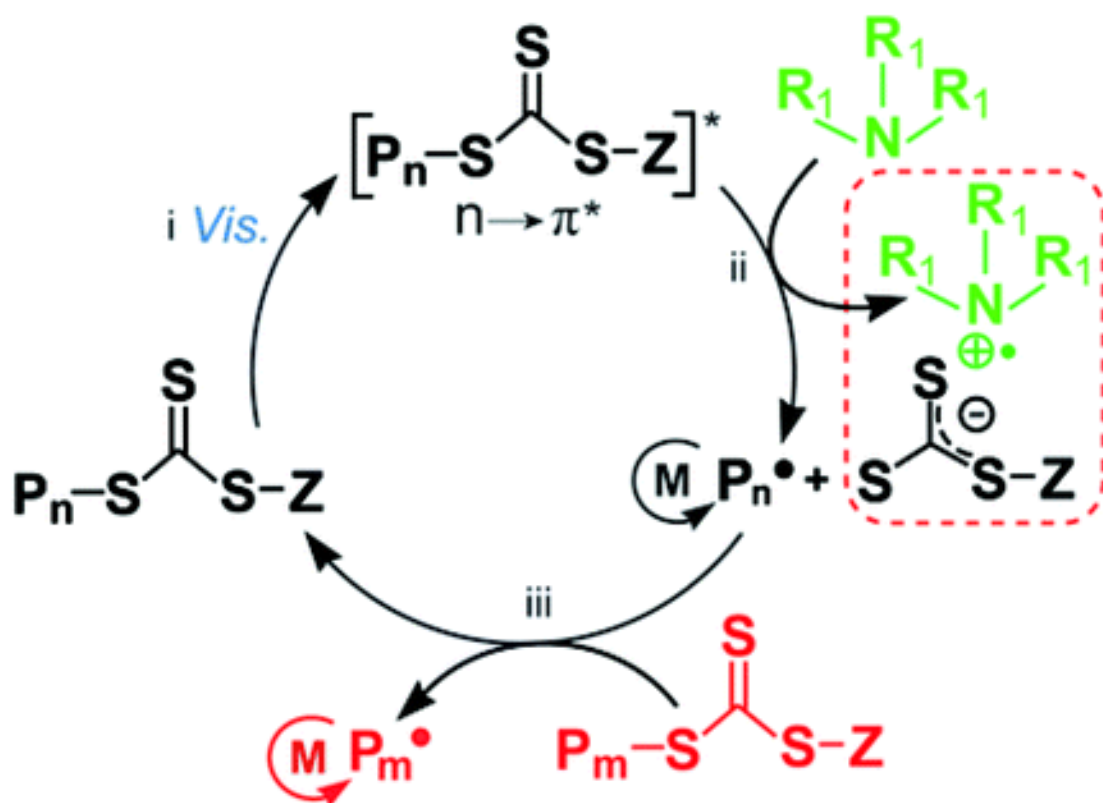

Scheme 2- showing the cycle of raft polymerisation present, and that it is still possible after the deoxygenation step.

Furthermore, the only additional molecule is that of a tertiary amine that, unlike metal ions or enzymes, can easily be filtered out of the reaction mixture at the end of the reaction if purified product is required.

This method was combined with the results from a paper written by the Gibson group of Warwick University which was researching into the antimicrobial activity of polymers made from readily commercially available monomers. This reported that the most successful polymer found was that of polydimethylaminoethyl methacrylate (PDMAEMA).

1.4 Aims and objectives

Herein, this study will focus on optimising the photo-raft process described above for use with PDMAEMA and confirm that this reaction is both controllable and reproducible. After which the reaction will be used to create a library of copolymers in an automated manner. These copolymers will hopefully, upon screening, provide a copolymer with improved antimicrobial properties to that of previously discovered PDMAEMA.

2. Experimental

2.1 Materials

All chemicals used were supplied as following. Dimethyl sulfoxide (analytical grade), Tetrahydrofuran, Triethanolamine, 2-cyano-2-propyl dodecyl trithiocarbonate (.97%), deuterated chloroform (99.9 atom % D), 2-(Dimethylamino)ethyl methacrylate (98%), methyl methacrylate (99%), ethyl methacrylate (97%), isobutyl methacrylate (97%), cyclohexyl methacrylate (97%), hydroxyethyl methacrylate (96%) , di(ethylene glycol) methyl ether methacrylate (97%), poly(ethylene glycol methyl ether) methacrylate(97%), poly(ethylene glycol methyl ether) methacrylate (97%) and mesitylene (analytical grade) were all purchased from Sigma-Aldrich at laboratory grade unless otherwise stated. Phosphate-buffered saline (PBS) was prepared by dissolving a remade tablet (purchased from Sigma-Aldrich) in 200 mL of distilled water to give a final composition of 0.01 M phosphate, 0.0027 M potassium chloride and 0.137 M sodium chloride, pH 7.4. P8116 SIGMA Nunc® 96 DeepWell™ plate, non-treated size 96 wells, maximum volume 1.3 mL, natural polypropylene wells round bottom (deep wells) were purchased from Sigma-Aldrich. Lysogeny broth (LB) broth part number L3022 was obtained from Sigma-Aldrich and made as directed. Middlebrook 7H9 Broth Base was obtained from Sigma-Aldrich and made as directed. The optical density (OD) of the bacteria was measured using a Perkin Elmer Lambda-35 UV/Vis spectrometer at 600 nm. Plastic cuvettes with a 1 cm path length were used.

2.2 Analytical Methods

NMR spectroscopy (¹H, ¹³C) was conducted on a Bruker DPX-300 spectrometer using deuterated chloroform as solvent. SEC analysis was performed on a Varian 390-LC MDS system equipped with a PL-AS RT/MT 2. Materials and Methods 11 autosampler, a PL-gel 3 μm (50 × 7.5 mm) guard column, two PL-gel 5 μm (300 × 7.5 mm) mixed-D columns held at 30 °C and the instrument equipped with a differential refractive index and a Shimadzu SPD-M20A diode array detector. Tetrahydrofuran (including 2% triethylamine) was used as the eluent at a flow rate of 1 mL.min⁻¹ . Data were analysed using Cirrus 3.2 software and molecular weight determined relative to narrow molecular weight PMMA standards (200 - 1.0 × 10⁶ g.mol⁻¹).

2.3 Instrumental methods

Blue 300 Units 3528 LEDs, 5m 12V DC Non-waterproof Light Strips, LED ribbons were purchased from amazon. Blue 300 Units 3528 LEDs, 5m 12V DC Non-waterproof Light Strips, LED ribbons were purchased from amazon. The liquid handling robot used was a Gilson 268 using 200 μL pipette tips. A 96 well plate centrifuge.

2.4 Synthetic Methods

All polymer syntheses were carried out in deep well 96 well plates. An example of which can be seen in figures d, d, and E.

2.4.1 Poly(dimethylaminoethyl methacrylate) synthesis of the 3 x 3 experiment

Triethanolamine (10 mg) was dissolved in dimethyl sulfoxide (20 μ L) and added to the well. 2-(Dimethylamino)ethyl methacrylate (50 μ L) was added to the well. Dimethyl sulfoxide (200 μ L) was also added. These steps were the same for all of the 9 wells used. After this 2-cyano-2-propyl dodecyl trithiocarbonate (0.2 mg in column 3, 0.4 mg in column 6 and 0.8 mg in column 9) was dissolved in dimethyl sulfoxide (10 μ L) and added to the corresponding wells well. 10 μ L of mesitylene was also added to each well. This yield a thick and viscous yellow liquid (stronger colour with higher amounts of 2-cyano-2-propyl dodecyl trithiocarbonate). Samples were analysed by ^1H NMR to determine conversion. Further analyse was done by SEC.

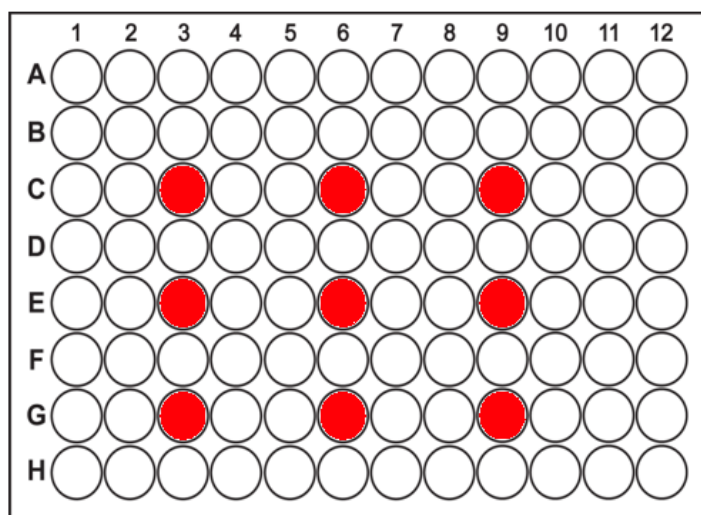

Figure 3- picture showing the layout of the plate.

2.4.2 Poly(dimethylaminoethyl methacrylate) synthesis of 60 polymer plate

Triethanolamine (10 mg) was dissolved in dimethyl sulfoxide (20 μL) and added to the well. 2-(Dimethylamino)ethyl methacrylate (50 μL) was added to the well. Dimethyl sulfoxide (200 μL) was also added. 2-cyano-2-propyl dodecyl trithiocarbonate (0.6 mg) was dissolved in dimethyl sulfoxide (10 μL) and then added to the well last. These values were used for all 60 wells used in the plate. 10 μL of mesitylene was also added to each well. This yield a thick and viscous yellow liquid. Five samples, chosen at random, were analysed by ^1H NMR to determine conversion. Further analyse was done by SEC.

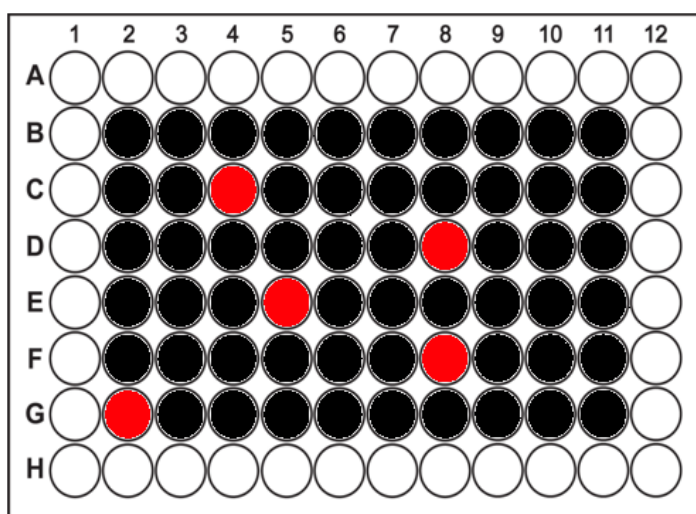

Figure 4- Picture showing the layout of the plate, with analysed samples highlighted in red

2.4.3 Poly(methyl methacrylate) synthesis of the 3 x 3 experiment

Triethanolamine (10 mg) was dissolved in dimethyl sulfoxide (20 μL) and added to the well. Methyl methacrylate (60 μL) was added to the well. Dimethyl sulfoxide (200 μL) was also added. These steps were the same for all of the 9 wells used. After this 2-cyano-2-propyl dodecyl trithiocarbonate (0.3 mg in column 3, 0.6 mg in column 6 and 1.2 mg in column 9) was dissolved in dimethyl sulfoxide (10 μL) and added to the corresponding wells well. 10 μL of mesitylene was also added to each well. This yield a thick and viscous yellow liquid (stronger colour with higher amounts of 2-cyano-2-propyl dodecyl trithiocarbonate). Samples were analysed by ^1H NMR to determine conversion. Further analyse was done by SEC.

2.4.4 Poly(methyl methacrylate) synthesis of 60 polymer plate

Triethanolamine (10 mg) was dissolved in dimethyl sulfoxide (20 μL) and added to the well. Methyl methacrylate (60 μL) was added to the well. Dimethyl sulfoxide (200 μL) was also added. 2-cyano-2-propyl dodecyl trithiocarbonate (0.75 mg) was dissolved in dimethyl sulfoxide (10 μL) and then added to the well last. These values were used for all 60 wells used in the plate. 10 μL of mesitylene was also added to each well. This yield a thick and viscous yellow liquid. Five samples, chosen at random, were analysed by ^1H NMR to determine conversion (can be seen in figure b). Further analyse was done by SEC.

2.5 Synthesis of copolymer library

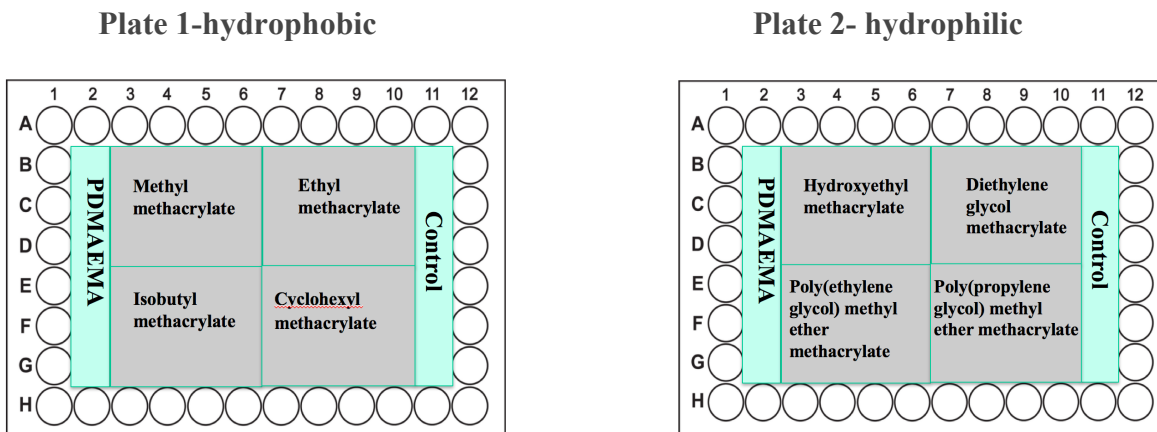

Figure 5- showing how the copolymer library plates were laid out.

Composition of all the occupied wells (the control column is left empty) is the same as found in 2.4.2. however instead of 200 μL dimethyl sulfoxide 1000 μL was added. Additional monomers were added in their respective quadrants.

In plate 1, in the methyl methacrylate quadrant, methyl methacrylate was added in the following amounts; 1.4 μL into B3, 2.8 into B4, 5.6 μL into B5 and 11.2 μL into B6. These amounts were the replicated in triplicate in the below rows (i.e. C3-6 and D3-6). In the ethyl methacrylate quadrant, ethyl methacrylate was added in the following amounts; 1.6 μL into B7, 3.2 μL into B8, 6.4 μL into B9 and 12.8 μL into B10. These amounts were the replicated in triplicate in the below rows (i.e. C7-10 and D7-10). In the isobutyl methacrylate quadrant, isobutyl methacrylate was added in the following amounts; 2.2 μL into E3, 4.4 into E4, 8.8 μL into E5 and 17.6 μL into E6. These amounts were the replicated in triplicate in the below rows (i.e. F3-6 and G3-6). In the cyclohexyl methacrylate quadrant, cyclohexyl methacrylate was added in the following amounts; 3 μL into E7, 6 into E8, 12 μL into E9 and 24 μL into E10. These amounts were the replicated in triplicate in the below rows (i.e. F7-10 & G7-10).

In plate 2, in the hydroxyethyl methacrylate quadrant, hydroxyethyl methacrylate was added in the following amounts; 2 μL into B3, 4 into B4, 8 μL into B5 and 16 μL into B6. These amounts were the replicated in triplicate in the below rows (i.e. C3-6 and D3-6). In the diethylene glycol methacrylate quadrant, di(ethylene glycol) methyl ether methacrylate was added in the following amounts; 3 μL into B7, 6 μL into B8, 12 μL into B9 and 24 μL into B10. These amounts were the replicated in triplicate in the below rows (i.e. C7-10 and D7-10). In the poly(ethylene glycol methyl ether) methacrylate quadrant, poly(ethylene glycol methyl ether) methacrylate was added in the following amounts; 4.6 μL into E3, 9.2 into E4, 18.4 μL into E5 and 36.8 μL into E6. These amounts were the replicated in triplicate in the below rows (i.e. F3-6 and G3-6). In the poly(propylene glycol) methacrylate quadrant, poly(propylene glycol) methacrylate was added in the following amounts; 6.4 μL into E7, 12.8 into E8, 25.6 μL into E9 and 51.2 μL into E10. These amounts were the replicated in triplicate in the below rows (i.e. F7-10 and G7-10).

2.6 Biological methods

2.6.1 Bacterial strains

The two bacterial strains used were Escherichia Coli and Mycobacterium Smegmatis. Mycobacterium Smegmatis was made using frozen stocks. This were removed from he freezer and on defrosting (fast process, takes 2-4 minutes) a mixture is made of 100 μ L of frozen stock culture per 10 mL of 7H9 growth medium. Escherichia Coli is slightly more complicated to make. First an E. Coli culture must be grown. This is done in much the same was a M. Smegmatis, with 100 μ L of frozen stock culture per 10 mL of LB growth medium. This is then left to grow. Grow is measured using UV-Vis at 600nm. When the optical density (OD) of this sample reaches 0.6 you have enough bacterial growth to use the culture. From this culture 100 μ L is taken and added to 10 mL (times up as appropriate).

2.6.2 Antimicrobial testing

The First step for the antimicrobial is testing is the serial dilution of the two copolymer plates. 8 serial dilutions of each plate were made. The serial dilution were made in normal 96 well plates, not the deep well plates. It is important to note that the only change between the serial dilution plates is the concentration of the copolymers, each copolymer is still in the same well as denoted in figure 3 and described above. In all 16 dilution plates the outer perimeter of wells were full of water (200 μ L) to ensure that any evaporation that occurs comes from them and not them sample wells. 50 μ L of each of the copolymer solutions were transferred across to the first of the serial dilution plates, to the same well coordinates. After this 25 μ L of PBS was also added to every well (including the control well column). This gives the first serial dilution plate. From this first plate, all subsequent serial dilutions were made. In the remaining 7 plates, 25 μ L of PBS is added to each all wells (apart from perimeter). Then from the first plate 25 μ L of each solution is taken and transferred to the second plate. Then 25 μ L from the second to the third. This continues down all 8 plates, with 25 μ L of the mixture being taken each time to give to the next plate. On the 8th plate, 25 μ L is again taken from each well, this is then discarded, so as to ensure that all wells have the same volume of liquid (50 μ L). This serial dilution process is carried out twice, for plate 1 and plate 2 separately. Giving a total of 12 plates. Once the serial dilution is achieved the plates will have concentration as shown below (table 2).

Plate number	Concentration (mg/ μ L)
1	1000
2	500
3	250
4	125
5	62.5
6	31.25
7	15.625
8	7.8125

Table 2- showing the different concentration of the different plates.

The first 4 serial dilutions (concentrations 1000-125) of each plate were taken and 50 μ L of the E. Coli sample solution was added. The second 4 serial dilutions (concentrations 62.5-7.8125) were taken and 50 μ L of the M. Smegmatis was added. This is done to PDMAEMAs

better activity against *M. Smegmatis* in comparison to the at *E. Coli*, and therefore lower concentrations are needed for an effective test. These were then incubated at 37 °C (72 hours for *M. smegmatis* and at for 18 hours for *E. coli*). Following this incubation period 25 µL of resazurin was added (one resazurin tablet (VWR) in 30 mL sterile PBS) and left for a further incubation period (24 hours for *M. smegmatis*, 4 hours for *E. coli*).

2.6.3 Resazurin

Resazurin is a dark blue liquid that, upon addition to a bacterial colony, will slowly be reduced by the bacteria present to the bright pink resorufin molecule, (this can be seen in figure 10). If no bacteria are present the resazurin molecule is not reduced and therefore the well stays blue in colour.

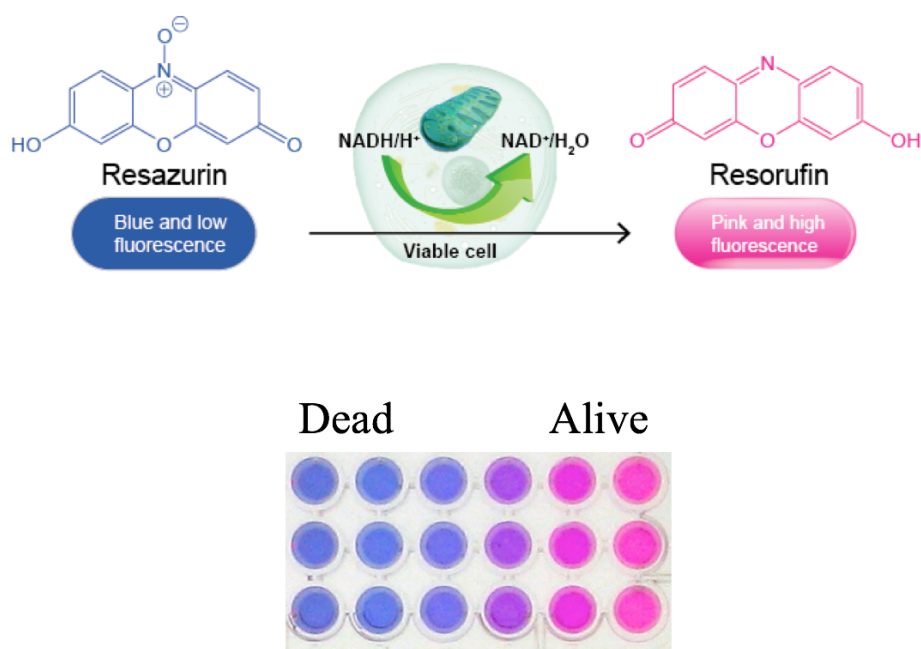

Figure 6 - showing the reaction process of the resazurin molecule.

2.6.4 further antimicrobial testing

Once successful “hits” have been identified, these the need to be further plated out so as to get an accurate Median Inhibitory Concentration (MIC).

“Hits” are the copolymers that displayed higher antimicrobial activity than that of PDMAEMA identified. Copolymer “hits” are only counted as successful if all 3 repeats are blue (i.e. if all 3 repeats successfully killed all bacteria present).

Once the “hits” have been identified these are then further plated out. This is done in a much simpler manner, with 2 successful “hit” triplicates per plate. The successful triplicates are plated out in the first column (column 2) with the first copolymer occupying wells B2, C2 and D2 and the second occupying wells, E2, F2 and G2 (Important note is that this is a new stage of testing and therefore requires the copolymer samples to be drawn from the original deep well plate). This serial dilution is done with the same amounts as the previous testing, however, each polymer is limited to only 1 plate this time. So 25 µL of PBS added to all

wells. Then 50 μL of copolymer sample was added to first column of wells. From this mixture 25 μL was taken from column 2 and placed in column 3, then 25 μL from column 3 to column 4 and so on, to give a serial dilution across the plate (practical example can be seen in figure X).

3. Results and Discussion

3.1 DMAEMA polymerisation

The initial DMAEMA polymerisation experiments were undertaken to ensure that the deoxygenation method using TTC as an electron shuttle would also be successful when using DMAEMA as the monomer. The reaction scheme can be seen in scheme 3. As the objective of the project was to create a synthesis method that could be theoretically used for high throughput drug discovery methods, and given that such experiments are universally carried out in multi well equipment, all experiments throughout the entirety of the project were undertaken in deep 96 well plates.

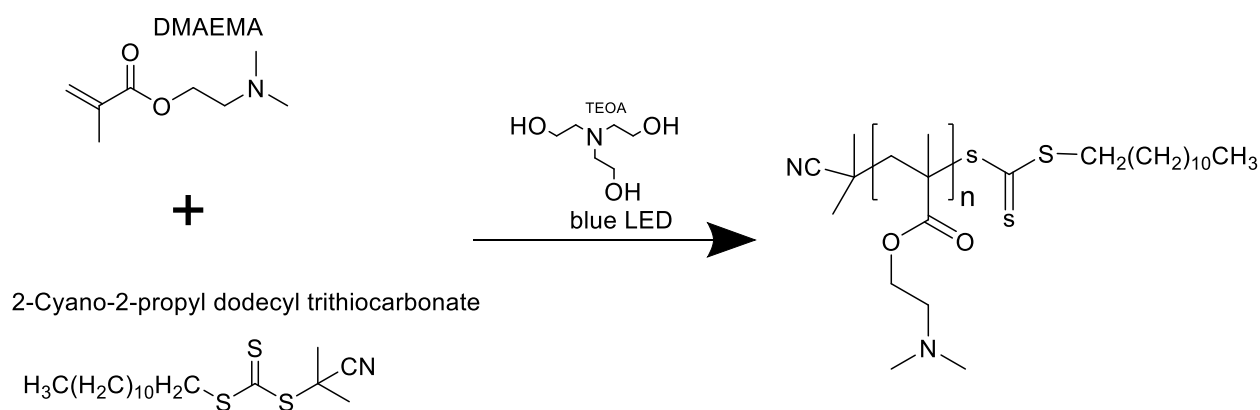

Scheme 3 – showing the polymerisation scheme for the formation of PDMAEMA

The first reaction's purpose was to show that this scheme was successful and that control over the degree of polymerisation (DP_n) was possible and replicable. To prove this control a reaction was set up as shown in figure x. Across the X axis of the plate the DP values decrease, with the sample in C3 having an intended DP of 100, C6 a DP 50 and C9 a DP 25. The subsequent rows are repeats with rows E and G following the same layout.

The reaction was analysed using ^1H NMR at time=0 and after a 24-hour period to determine conversion (see figure7). The vinyl peaks of the two corresponding graphs (see supplementary information) were compared to show conversion. This was done by analysing the change in integration value of the peaks corresponding to the vinyl protons relative to an internal standard (mesitylene). All 9 of the reactions had conversion values of over 95% (table 2).

Experiment well	Monomer	DP	Conversion
C3	DMAEMA	100	95%
C6	DMAEMA	50	96%
C9	DMAEMA	25	98%
E3	DMAEMA	100	96%
E6	DMAEMA	50	95%
E9	DMAEMA	25	95%
G3	DMAEMA	100	96%
G6	DMAEMA	50	97%
G9	DMAEMA	25	98%

Table 2- table displaying NMR conversion data for the 3x3 polymerisation of DMAEMA

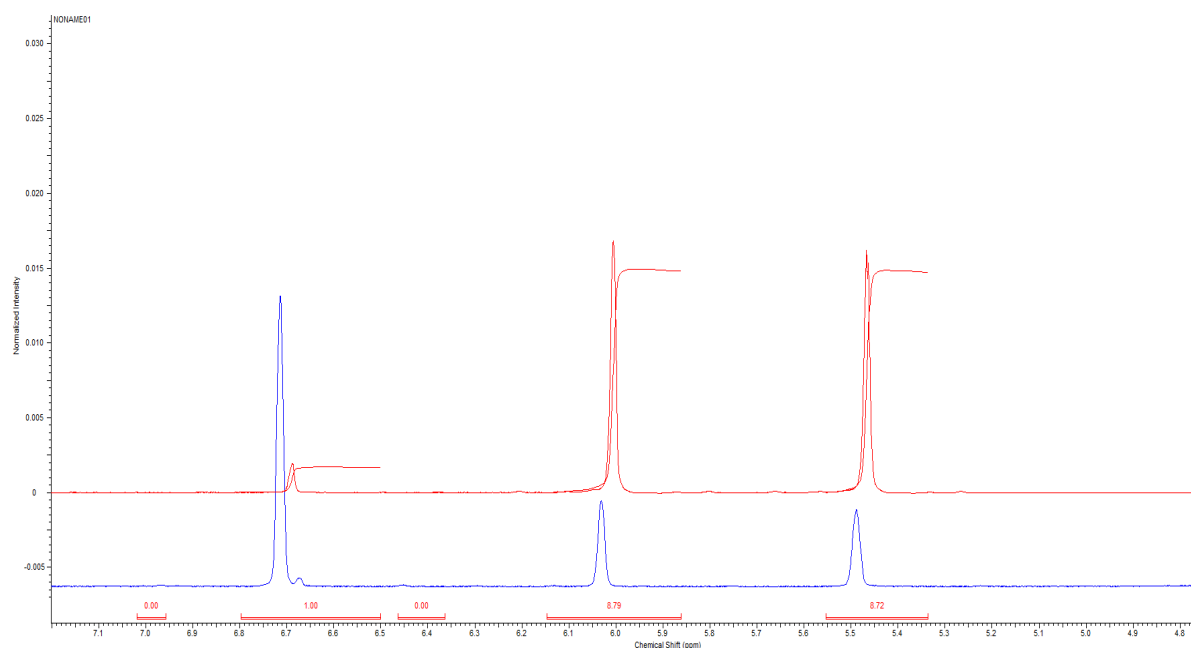

Figure 7- A ^1H NMR showing the difference in before the reaction (blue) and after reaction (red). Far left peak is that of mesitylene, the concentration of which does not change. The other 2 peaks are the vinyl peaks, corresponding to the double bond that has to be broken to form a polymer.

Further analysis was carried out using SEC on the 9 samples and as shown in graph 2, clear separation of the 3 DPs was attained, with the repeats overlapping perfectly. Thus demonstrating that, on a small scale at least, the reaction is both successful and controllable.

However, as stated small scale research is not the aim the next step was to perform a high throughput experiment. To this end 60 wells of the deep plate were used (see figure 10). In this experiment all 60 wells had a DP ratio of 75. This was also the first step in which the liquid pipetting robot was used. The reaction was separated into 3 mixtures. The first was the

monomer (DMAEMA), the second was the TEOA that was dissolved in DMSO and the third was the RAFT agent, also dissolved in DMSO. These were then sequentially added to the plate by the robot. This methodology was followed to ensure accuracy, eliminate human error in the pipetting stage and as a proof of concept. In this experiment five random wells were selected by members of the research group who had not previously been involved in the project. These five samples were then analysed using the same techniques employed in the previous experiment, with all 5 reactions showing a conversion above 95%. The SEC data was also overlaid perfectly proving that even at high volumes the polymerisation reaction in relation to the DMAEMA monomer was both successful and controllable.

3.2 HEMA and MMA polymerisation

Due to the project aim of copolymerising DMAEMA with other monomers the same experiments were also repeated with HEMA and MMA replacing DMAEMA. The purpose of these experiments was to show that the addition of different monomers will not disturb the efficiency of the overall reaction. As demonstrated the repeats using different monomer units were just as successful, with the HEMA and MMA reactions equalling that of the DMAEMA reaction in both high conversion and DP controllability.

3.3 Copolymerisation reaction and plate layout

As both the DP control and conversion tests were both successful the next phase in the project was to establish the library of copolymers.

The first step towards this was the selection of the monomers to include alongside PDMAEMA. The choice was made to test two groups of 4 polymers. One with hydrophobic monomers and one with hydrophilic monomers. These were selected due to the generally reported idea that increases in hydrophobicity stimulates accelerated antimicrobial activity. The obvious counter group to this is a hydrophilic group. Given the known problems with toxicity and solubility involved with more hydrophobic groups the decision was made to limit the inclusion of these new monomers to a maximum of 20%. The reason that solubility is an issue is that, due to the end goal of using this to treat humans, all antimicrobial testing was done in PBS. The 8 monomer units chosen are shown in figure 10.

With the 8 monomers chosen now focus shifted on to how the copolymers would be laid out in the plate. It was decided early on that 1 starter plate for each group would be enough. For this the hydrophobic plate will be used as an example (see figure 8).

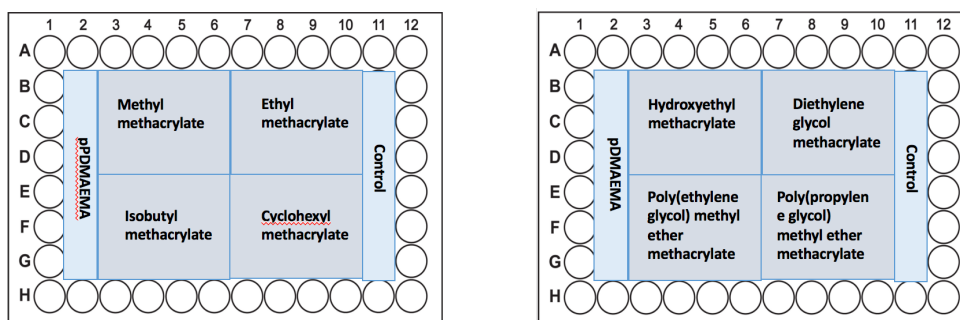

Figure 8- showing how the copolymer library plates were laid out.

The outer wells of the plate were left empty in this and in all antimicrobial testing plates. The wells were later filled with water. This was to reduce the impact evaporation had on the centre wells when the plates were being incubated (for the bacteria to grow). The first column was filled with PDMAEMA. This was so that on the serial dilution of the plates, a clear indicator was visible and when it reached the level at which a more successful copolymer had been made. Then in each of the 4 monomer quadrants the percentage inclusion of that monomer increased in 5% increments. For example, in the methyl methacrylate quadrant, in well B3 the polymer was a random copolymer with 95% DMAEMA and 5% MMA. In well B4 it was 90% DMAEMA and 10% MMA. In B5 85% DMAEMA and 15% MMA until the inclusion of the monomer reached 20% (in this case, in well B6). The rows in each quadrant were repeats. So row B,C and D have the same composition, as do E, F and G. This was carried out so that the results appear in triplicate, allowing for immediate identification of the successful copolymer. A copolymer was only considered a success if all 3 of the repeats successfully kill the bacteria present. There is also a control column. This was left devoid of polymer, with only bacteria added later to this well to act as the positive control.

The formation of these plates of copolymer was enabled by the liquid pipetting robot present in the lab. Once the machine was set up pipetting would take 15-20 minutes per plate depending on the complexity of the instructions given to the robot. After this was finished, the plate was wrapped in blue LED lights and put into a draw for 24 hours. After this the copolymers were transferred to a plate with an identical layout, again using the robot. However, in this plate there were size exclusion filters fitted, on the underside of which was affixed a collection plate. These filter plates were then placed in a centrifuge for 45 minutes. The purpose of this step was for all the smaller unreacted molecules to drain into the collection plate, leaving a purified sample of polymer.

3.4 Antimicrobial testing

Using these purified samples antimicrobial testing was then undertaken. The microbial testing was carried out on two types of bacteria, the first was *Escherichia coli* (E. Coli) and the second was *Mycobacterium smegmatis* (m. smeg). These two were chosen because of their differing cell wall structures. Furthermore, these bacterial species were tested in the previous paper and therefore are necessary to prove that the new copolymer is superior to that of pure PDMAEMA.

After the first set of testing none of the copolymers successfully killed below the DMAEMA values found in the previous paper.¹⁸ However, there was an error in the testing. This was obvious as the PDMAEMA column was also becoming ineffective far above the previously reported numbers. However, after several repeats it was proved to not be an erroneous result. Upon revision of the procedure the only faulty step found was that of the filter plates and subsequent centrifuging. With this in mind the next step was to see how effective these filters were. This was done after the centrifuge step by freeze drying the samples to give a mass value. It was found that the filters were retaining almost no polymer, on average about 0.02 mg instead of the 2 mg that it was supposed to. The reason for this was assumed to be due to the fact that most filter plates are optimised for separating out proteins rather than polymers.

Due to the filtering step no longer being an option it meant that samples were taken directly from the initial reaction plates. 100 μ L of the reaction mixture from each well was taken and diluted with 900 μ L of PBS. The dilution was carried out in an identical deep well plate. The

issue here was that monomers are known to be highly toxic. This, along with what was left of the RAFT agent and the TEOA, whose toxicity is unknown, meant that these impurities could

lead to false positives. Therefore, testing was carried out on the toxicity of the base components of the reaction (see figure 9).

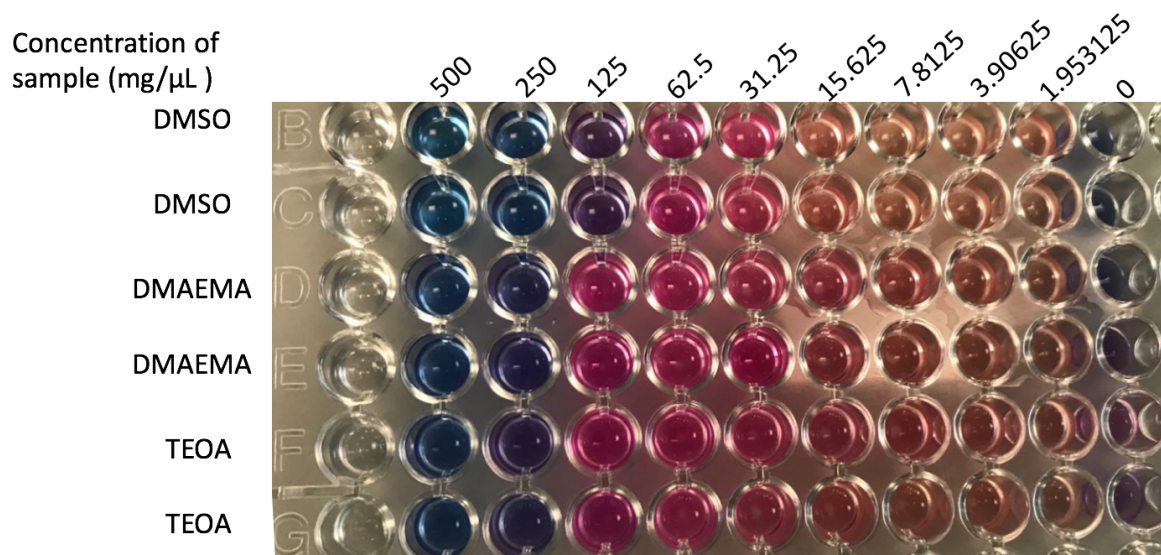

Figure 9- image showing the antimicrobial testing of the base components of the reaction.

The experiment looking into the base components proved that, in the concentrations used in the antimicrobial testing, none of them would result in the killing of the bacteria, therefore, giving no risk of false positives.

The antimicrobial testing was then repeated. However, again the results obtained were still vastly different results from those in previous literature, with PDMAEMA activity 3 to 4 times worse than reported.¹⁸ On a closer study of the reaction mechanism however the fact that the DMAEMA monomer also has a tertiary amine side chain represented an issue that had not been previously considered. It was therefore theorised that the reaction was proceeding along the expected pathway, however, the side chains of the polymer had been oxidised instead of the supposedly sacrificial TEOA. This small change would have been impossible to detect analytically due to the large and differing sizes present in the creation of a polymer.

To test this theory a simple experiment was undertaken. In the first column of a plate PDMAEMA was made using increasing amounts of TEOA in the synthesis. This first column was then serial diluted across the rest of the plate, with halving concentration values each time (see figure 10).

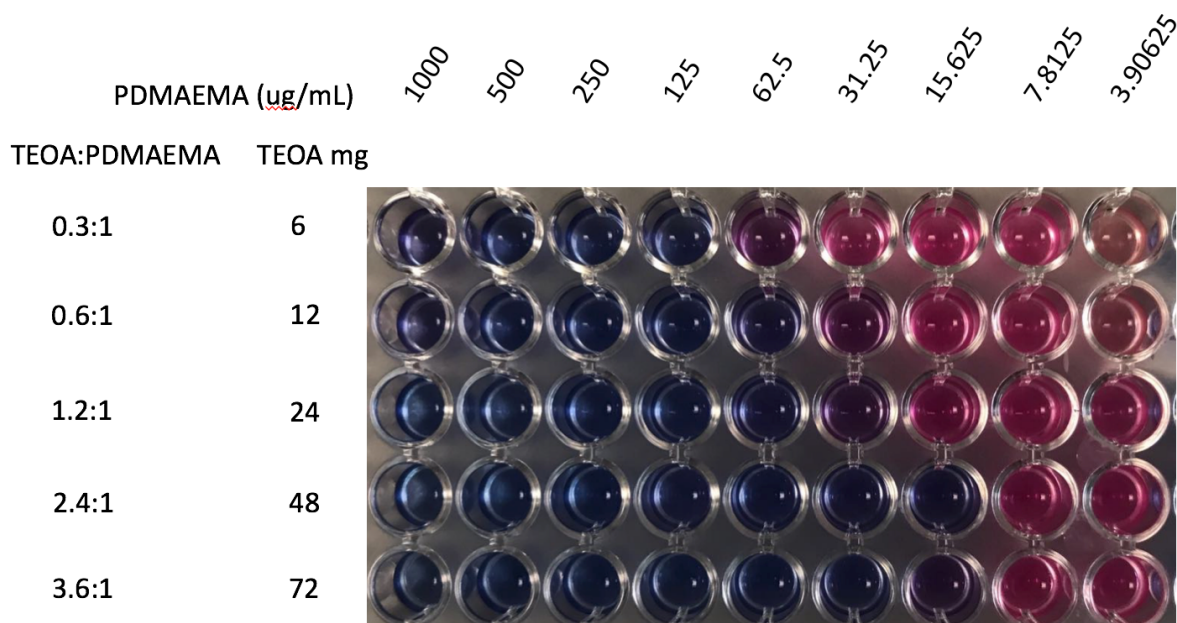

Figure 10- Image showing the effect that different amounts of TEOA have on the end antimicrobial activity of the polymer.

This showed that with the higher amount of TEOA present, better activity was achieved. The activity increased to a point that agreed exactly with the previously reported literature values.¹⁸ This lends credence to the argument that an excess of TEOA is needed to ensure the deoxygenation pathway proceeds using TEOA molecules and not DMAEMA's tertiary amine. It also lends further support to the proposed mechanism by which this deoxygenation works.

Now that the PDMAEMA control is reporting the expected values this approach was then applied to the creation of the copolymers. With the removal of the filtration step and the realisation of the need for an excess of TEOA the results were now successful (see figure 8). This resulted in multiple successful copolymers.

The successful copolymers were then further plated out in the same way as the TEOA test, with the first usable column containing the polymers and the rest of the plate a serial dilution of those (for example see figure 11).

This was carried out so that there would be a more precise number and therefore it would be known how much more effective the copolymers were in comparison to PDMAEMA.

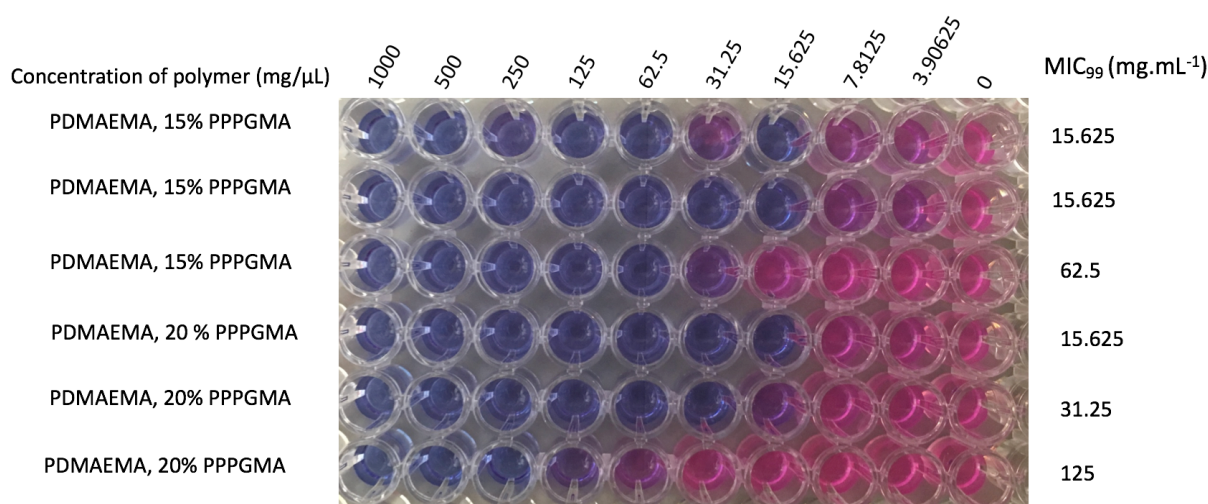

Figure 11 – showing the further testing of successful polymers.

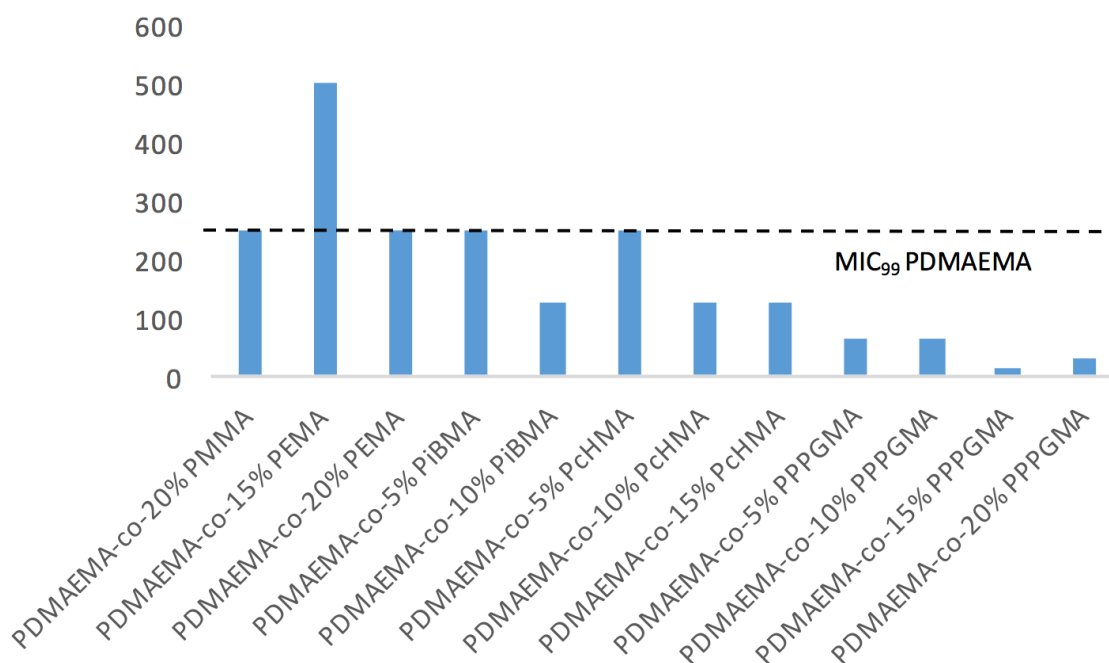

Figure 12- bar chart showing the vast increase in activity of the new copolymer. It is important to note that the aim is for the lowest possible number (i.e. the lowest concentration capable of killing the bacteria)

This next step of the experiment turned out to be a huge success, with results far superior to previous studies. In the previous paper the lowest concentration that PDMAEMA killed at was 250 mg/ μ L when tested against E. Coli. The experiment (see figures 11 and 12) yielded results that are 16 times as effective bringing the lowest concentration down from 250 to 15.625 mg/ μ L. While this was still not quite comparable to that of antibiotics, concentrations of which are between 3-6 mg/ μ L depending on the antibiotic used, it closed the gap hugely and really brings antimicrobial cationic polymers into range to be truly competitive. A major point of interest is also that this success came about from the 15% inclusion of a hydrophilic monomer (PPPGMA). This disproves the major theory at the moment that increased hydrophobicity makes for better antimicrobial polymers. This is a major positive as this could

also mean that these new copolymers are more highly selective towards bacteria and will not damage human cells.

At the genesis of this project the hypothesis was that the group with hydrophobic polymers would yield some copolymers that were better than PDMAEMA, and the group of hydrophilic monomers would act as a negative control group and mainly create copolymers that had less activity. This was assumed due to the almost linear behaviour on which others have commented in regard to increasing hydrophobicity. It was also hypothesised that, due to the fact that PDMAEMA is more effective at killing *M. Smeg* (MIC of 16 mg/ μ L) than *E. Coli* (MIC 250 mg/ μ L), that any successful copolymer would show improvement versus both bacteria. This however proved not to be the case. Whilst the copolymer with PPPGMA showed huge improvements versus *E. Coli* it showed no change versus *M. Smeg*. This result not only disproves the current theory about how cationic polymers destroy the cytoplasmic membrane it also shows that some level of bacterial specificity is possible without complex customisation of the polymers.

4. Conclusions and Future work

4.1 Conclusions

4.1.1 optimisation of the photo-RAFT process

The ability to polymerise PDMAEMA, both on its own and with subsequent monomer inclusion in a controlled fashion by the RAFT process utilising the deoxygenation pathway of a tertiary amine and a TTC, was confirmed.

4.1.2 Making a copolymer library

Utilising the polymerisation process that was confirmed above a library of copolymers was formed with DMAEMA and 8 different monomers with varying rates of monomer inclusion.

4.1.3 discovering a copolymer with a lower MIC value than that of PDMAEMA

A copolymer was discovered (85% DMAEMA 15% PPPGMA) which was 16 times as effective as PDMAEMA against E. Coli. However, no improvement was seen in regard to its ability to kill M. Smegmatis.

4.1.4 the creation of a high throughput polymer process

The creation of a high throughput polymer method was a success with a polymerisation process that was not only easy to scale to high throughput but one that was heavily automated. Throughout the 18 week duration of the project 1,236 individual polymers were made from which 7,323 individual antimicrobial assays were undertaken. Within a 24 hour period in the labs 120 individual polymers were made.

4.2 Future Work

Immediate future work should be focused on testing the biocompatibility of the successful copolymer. An alternate strategy to this would be to use this proven high throughput technique to further investigate more copolymers, or even start the inclusion of 3 monomer units to for terpolymers.

In the longer term it would be prudent to investigate the mechanism of action of cationic polymers due to the fact that the results herein disagree with generally accepted theories. This makes the subject of cationic polymers much more promising due to the fact that it has now been shown that increased hydrophobicity does not lead to improved antibacterial activity. This means that more effective polymers can be made that pose significantly less risk to human cells.

5. References

- 1 C. L. Ventola, *P T*, 2015, **40**, 277–83.
- 2 S. Reardon, *Nat. News*, , DOI:10.1038/nature.2015.19037.
- 3 *Centers Dis. Control Prev.*, 2013, 10–15.
- 4 *,† El-Refaie Kenawy, ‡ and S. D. Worley and R. Broughton§, , DOI:10.1021/BM061150Q.
- 5 K.-S. Huang, C.-H. Yang, S.-L. Huang, C.-Y. Chen, Y.-Y. Lu and Y.-S. Lin, *Int. J. Mol. Sci.*, , DOI:10.3390/ijms17091578.
- 6 K. Kuroda, G. A. Caputo and W. F. DeGrado, *Chemistry*, 2009, **15**, 1123–33.
- 7 J. L. Grace, J. X. Huang, S.-E. Cheah, N. P. Truong, M. A. Cooper, J. Li, T. P. Davis, J. F. Quinn, T. Velkov and M. R. Whittaker, *RSC Adv.*, 2016, **6**, 15469–15477.
- 8 *J. Memb. Sci.*, 2014, **466**, 18–25.
- 9 *J. Memb. Sci.*, 2014, **466**, 18–25.
- 10 *Mater. Sci. Eng. C*, 2014, **41**, 354–362.
- 11 Y. Chen, B. Pidhatika, T. von Erlach, R. Konradi, M. Textor, H. Hall and T. Lühmann, DOI:10.1116/1.4878461.
- 12 A. Jones, A. Mandal and S. Sharma, *J. Appl. Polym. Sci.*, , DOI:10.1002/APP.41931.
- 13 M. Shahzad, E. Millhouse, S. Culshaw, C. A. Edwards, G. Ramage and E. Combet, *Food Funct.*, 2015, **6**, 719–729.
- 14 F. Oytun, M. U. Kahveci and Y. Yagci, *J. Polym. Sci. Part A Polym. Chem.*, 2013, **51**, 1685–1689.
- 15 G. Ng, J. Yeow, J. Xu and C. Boyer, *Polym. Chem.*, 2017, **8**, 2841–2851.
- 16 J. Tan, D. Liu, Y. Bai, C. Huang, X. Li, J. He, Q. Xu and L. Zhang, , DOI:10.1021/ACS.MACROMOL.7B01219.
- 17 Q. Fu, K. Xie, T. G. McKenzie and G. G. Qiao, *Polym. Chem.*, 2017, **8**, 1519–1526.
- 18 D. J. Phillips, J. Harrison, S.-J. Richards, D. E. Mitchell, E. Tichauer, A. T. M. Hubbard, C. Guy, I. Hands-Portman, E. Fullam and M. I. Gibson, , DOI:10.1021/ACS.BIOMAC.7B00210.