



Pion Production from Water-Cooled Targets

Stephen Brooks / s.j.brooks@rl.ac.uk
UKNF meeting, Warwick, April 2008

Contents

1. Recap of current UKNF solid target
2. Pros and cons related to water cooling
3. Results from MARS 15.07
 - Including water in & lengthening the target
 - Pion yield (reabsorption)
 - Additional heating
 - Pion temporal distribution
- Conclusions

1. Recap of current UKNF solid target

Traditional UKNF Solid Target

- $p^+ \rightarrow \text{target} \rightarrow \pi^+, \pi^- \rightarrow \mu^+, \mu^- \rightarrow \text{neutrinos}$
- Radiation-cooled solid rods of tungsten
 - Replaced every 50Hz beam pulse by chain or wheel (~200 in whole loop)
- 2-3cm diameter, 20-30cm length
- Inside initial 20T solenoidal capture field
 - Usable bore ~20cm diameter
 - Pions tend to spiral in magnetic field

Pion Motion

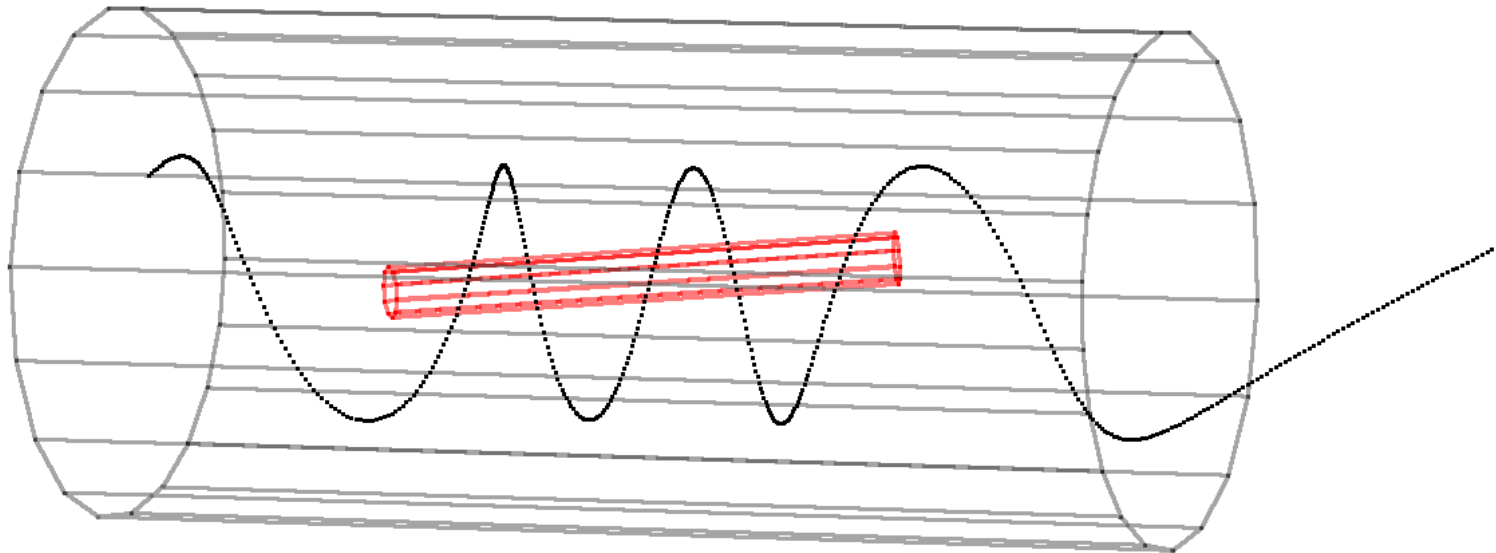

Main Design Problems

- Direct heating of the target from energy deposition
- Pions becoming reabsorbed
 - Target being too wide
 - Re-entering the target due to magnetic field
- Reabsorption produces more heating!
- A total of 20-30cm of high-Z target material thickness seems optimal

Where does the proton beam power go?

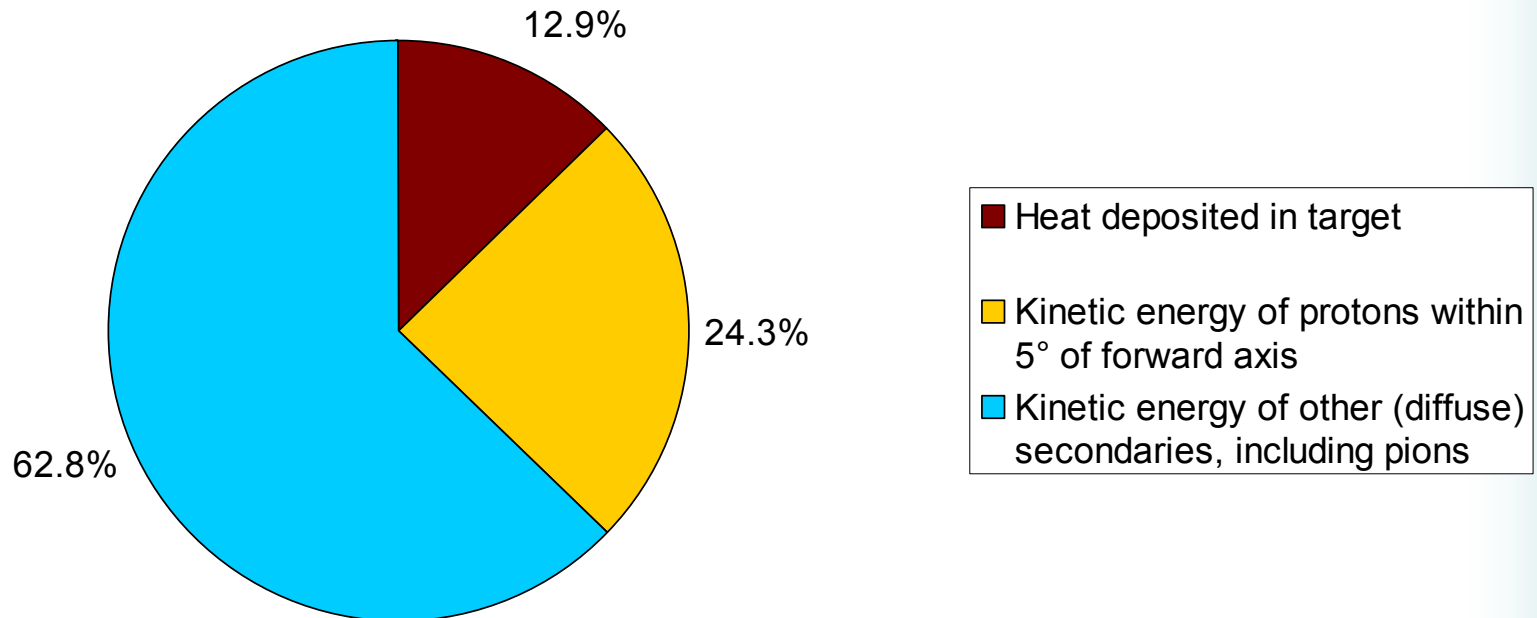

Figures from a **10GeV** proton beam (ISS baseline) hitting a 20cm long, 2cm diameter tantalum rod target

Muon Transmission from MARS15- Generated Pions

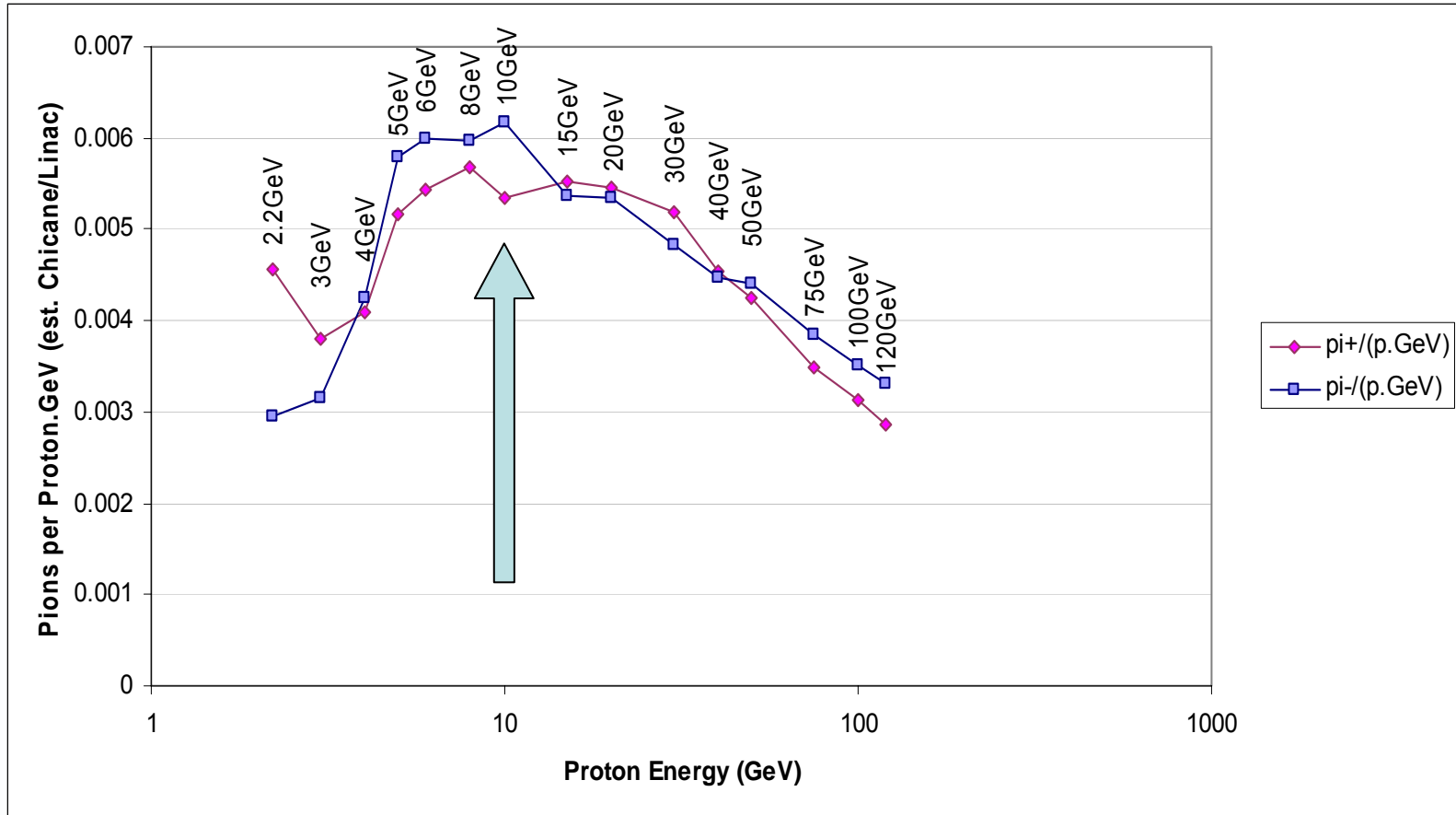

Energy Deposition in Rod (heat)

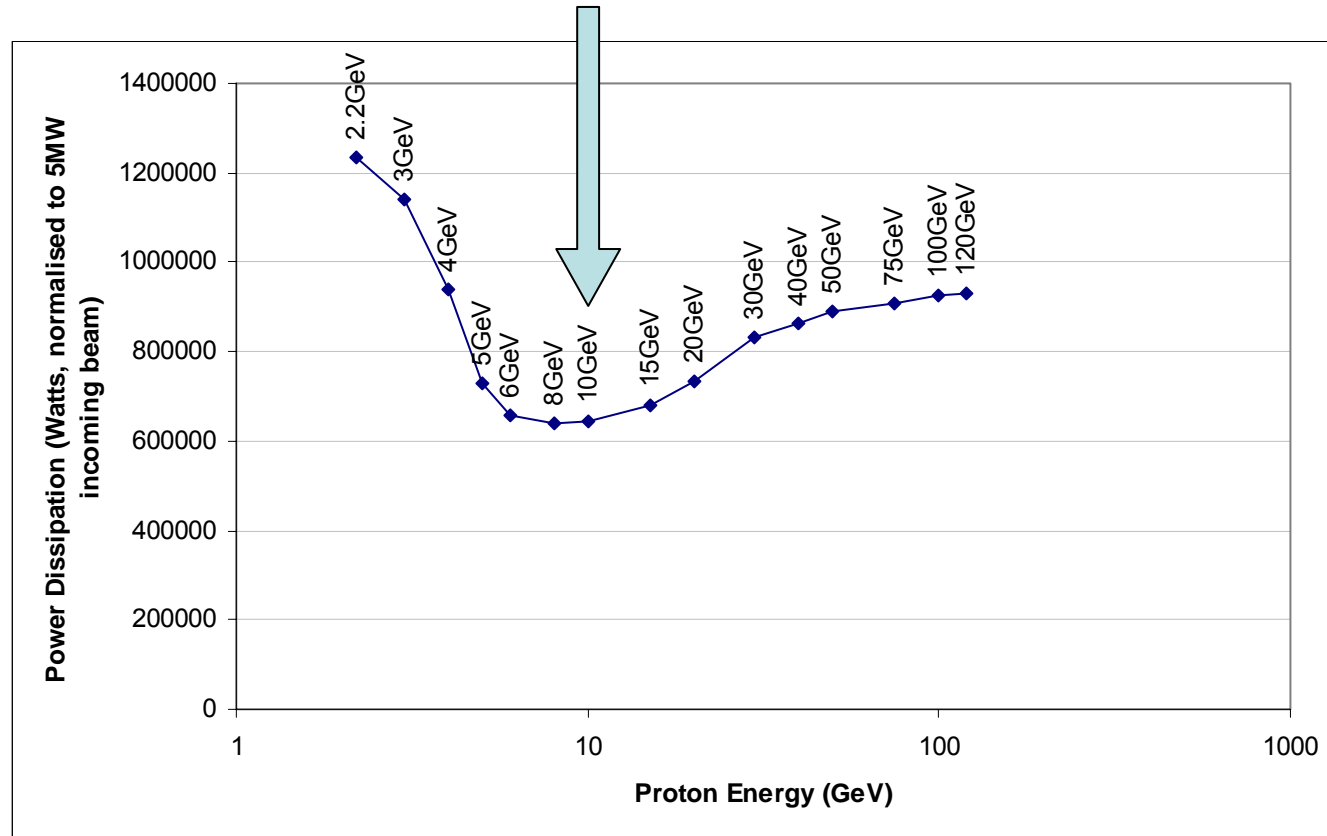

- Scaled for 5MW total beam power

Not Multi-Megawatt Heating

Machine	Beam power	Proton energy	Heating power
ISS beam	4MW	10GeV	514kW (x3)
UK neutrino factory scenarios	4MW	8GeV	512kW
	5MW	10GeV	643kW (x4)
	5MW	8GeV	640kW
 neutron source	169kW	800MeV 211μA	169kW (x1)

2. Pros and cons related to water cooling

Why it “wouldn’t work”

- Additional water would reabsorb too many pions
 - It would also increase heating in itself
- Increasing the target length would increase longitudinal time-spread of pions
 - 1m length = 3ns > 1ns RMS of proton beam
- Water-cooling has a maximum of 1MW
 - Would require 50% water in the small target

False Assumptions Corrected

- Additional water would reabsorb too many pions
 - $\rho_{\text{Water}} = 1.0 \text{ g/cc}$, $\rho_{\text{tungsten}} = 19.2 \text{ g/cc}$
- Increasing the target length would increase longitudinal time-spread of pions
 - Pions of interest $>250 \text{ MeV/c}$ momentum
 - $\beta > 0.87$, $\beta_{\text{protons}} = 0.996$, only lag matters
- 1MW is enough capacity

Advantages of Water Cooling

- Conventional technology
 - Many examples in operation
 - Including elsewhere in the target assembly! E.g. cooling for the normal-conducting solenoids
 - No solid moving parts (apart from pumps)
 - Radioactive flow loop isn't liquid mercury
 - Although there is still some tritium to deal with
- All parts of target stay below about 200°C

Disadvantages of Water Cooling

- Water will cavitate if the instantaneous temperature rise is too high, erode walls
 - Also if the flow rate is too high for pressure
- Flow manifold has to be somewhere and enter/exit the target
- Pressures may have to be large to induce sufficient flow rate
- Relies on fluid dynamics, requires much more careful design than in this talk

Naïve Flow Rate Calculation

- Assumes perfect:
 - Conductivity of metal target pieces
 - Thermal conduction from target to water
 - Mixing of water
- $P_{in} = 700\text{kW}$; $\Delta T = 50\text{K}$
- Flow rate 3.34 kg/s
- Speed 10.6 m/s for 2cm diameter pipe
 - Will be more than this realistically

3. Results from MARS 15.07

Simulation Geometry

4×4 = 16 runs

Particles logged at end-plane

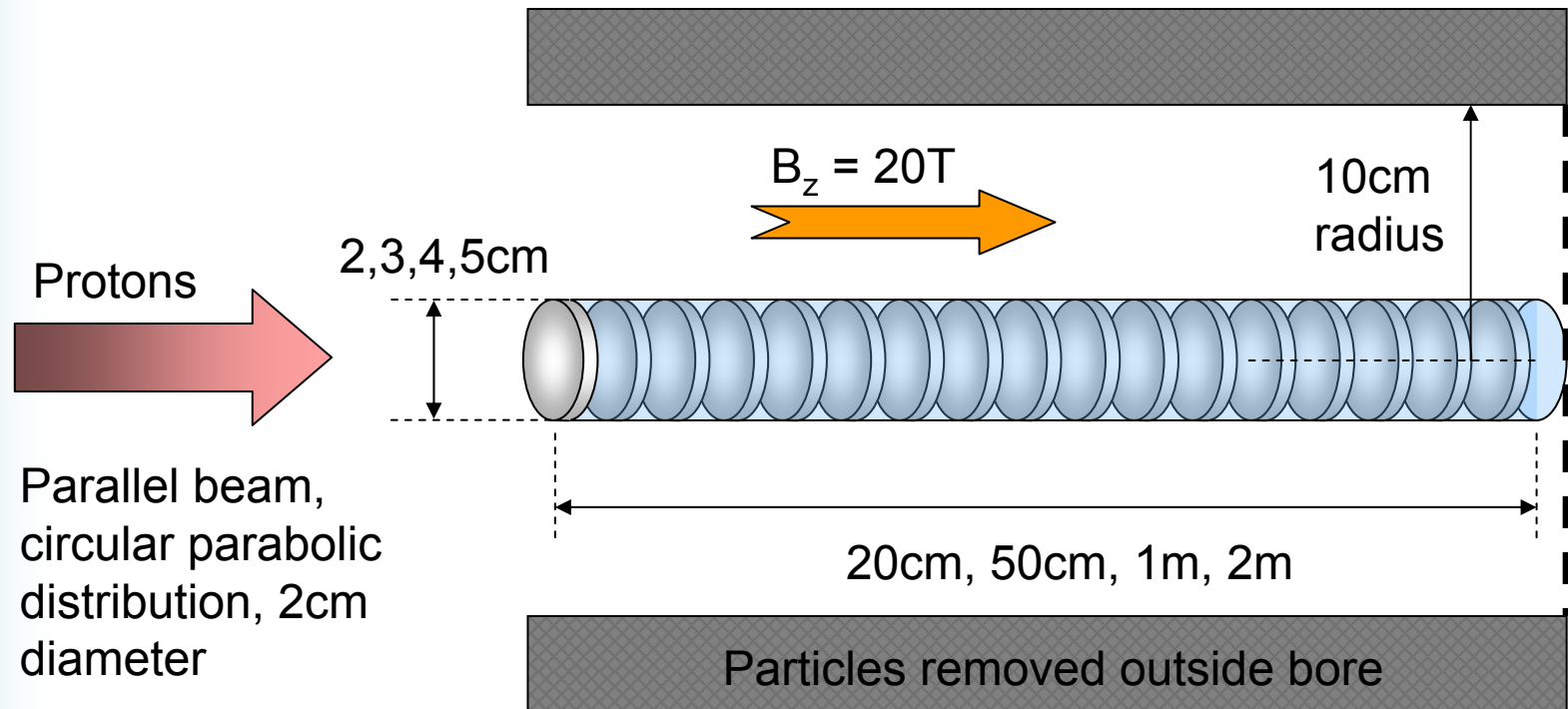

Tantalum "coin", 2mm thick →

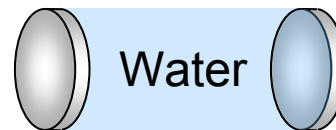

100 coins in target for 20cm total Ta thickness

Three Figures of Merit

- Useful pion yield
 - Weighted depending on (p_L, p_T) momenta
- Amount of heating in the system
 - How much does the water contribute?
- Time-spread acquired from long target
 - Only interested in “useful” pions here too

Useful Pion Yield

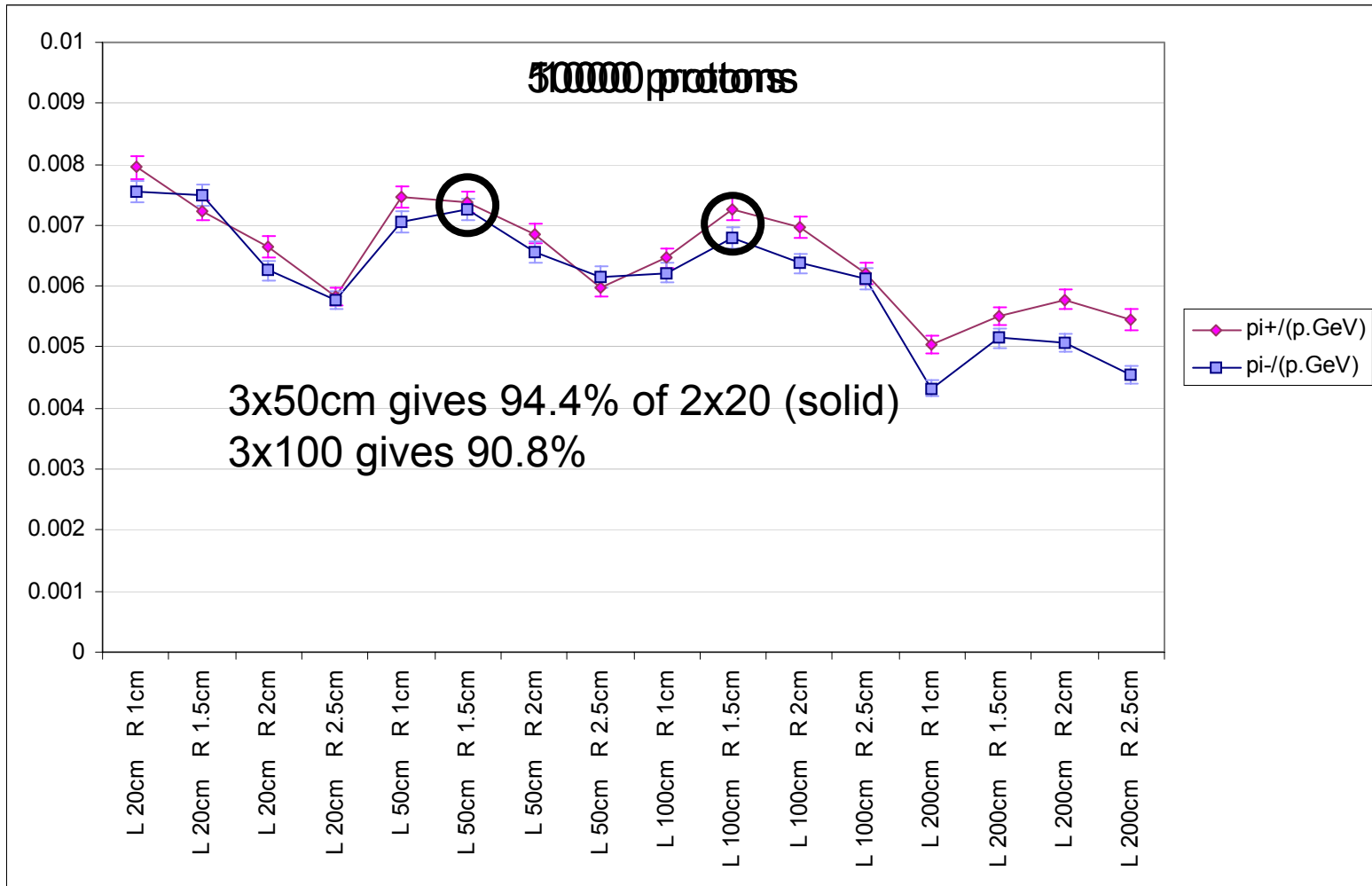

Amount of Heating

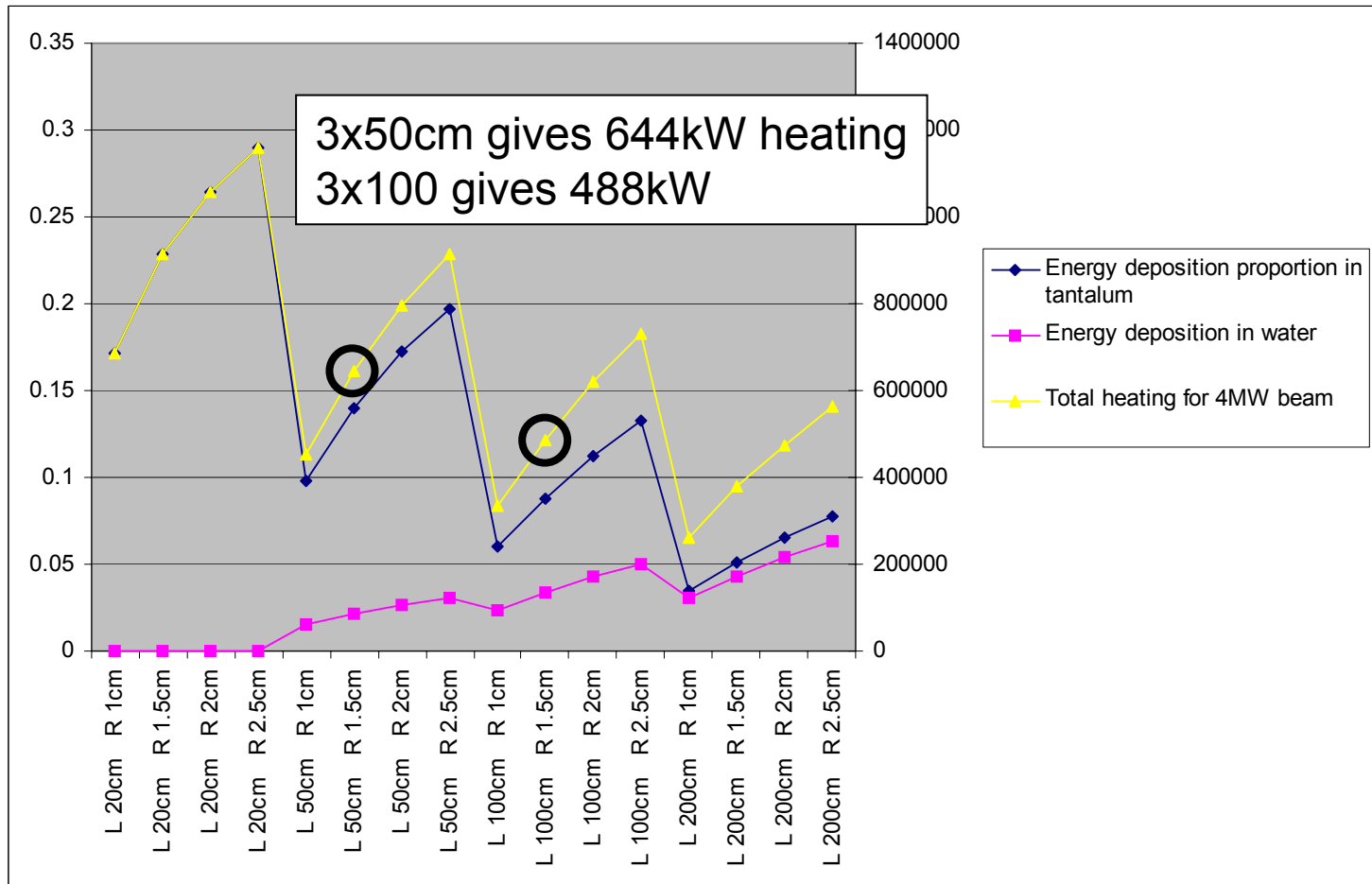

Arrival Time Distribution

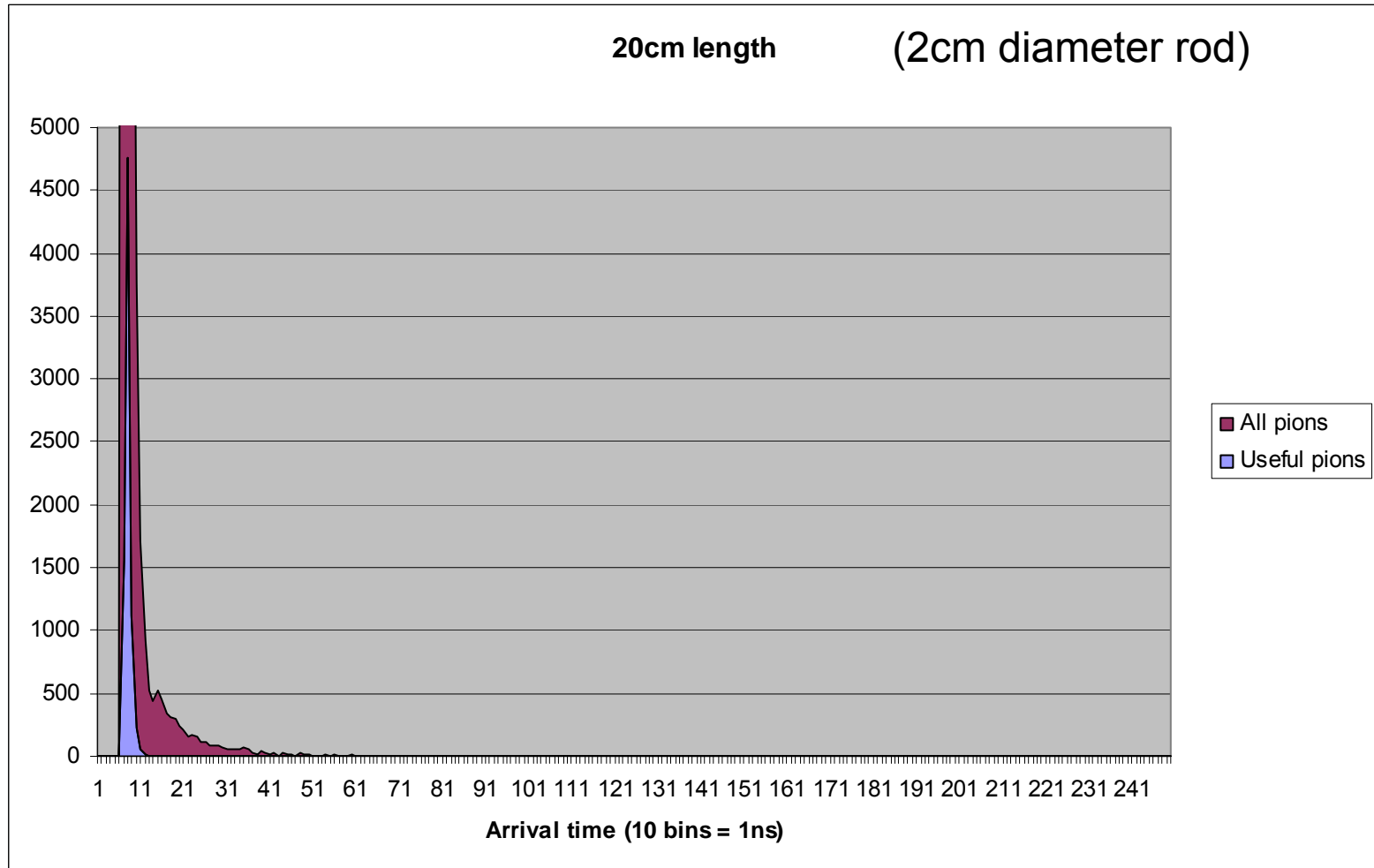

RMS of Useful Arrival Times

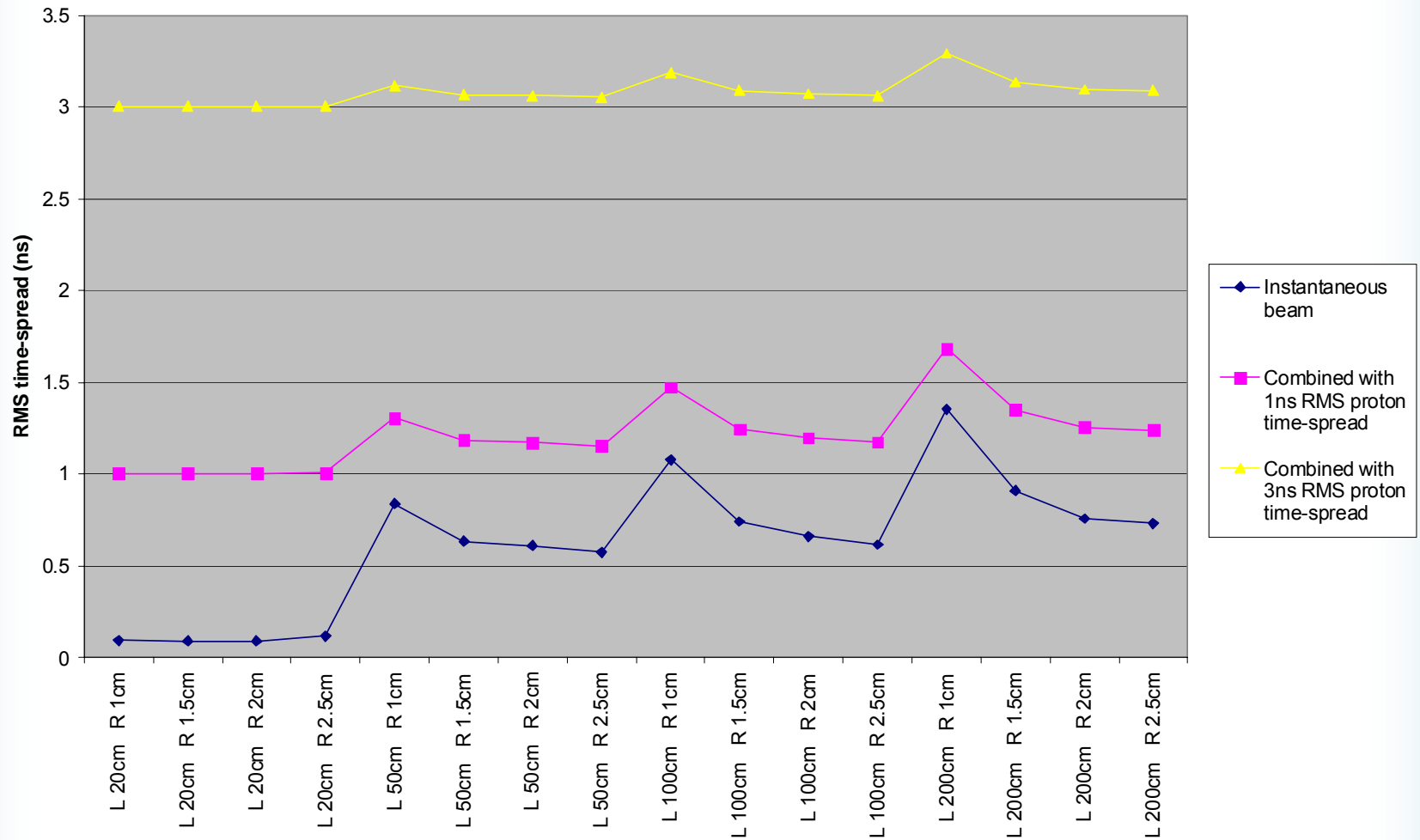

Modified Geometry

4×4 = 16 runs

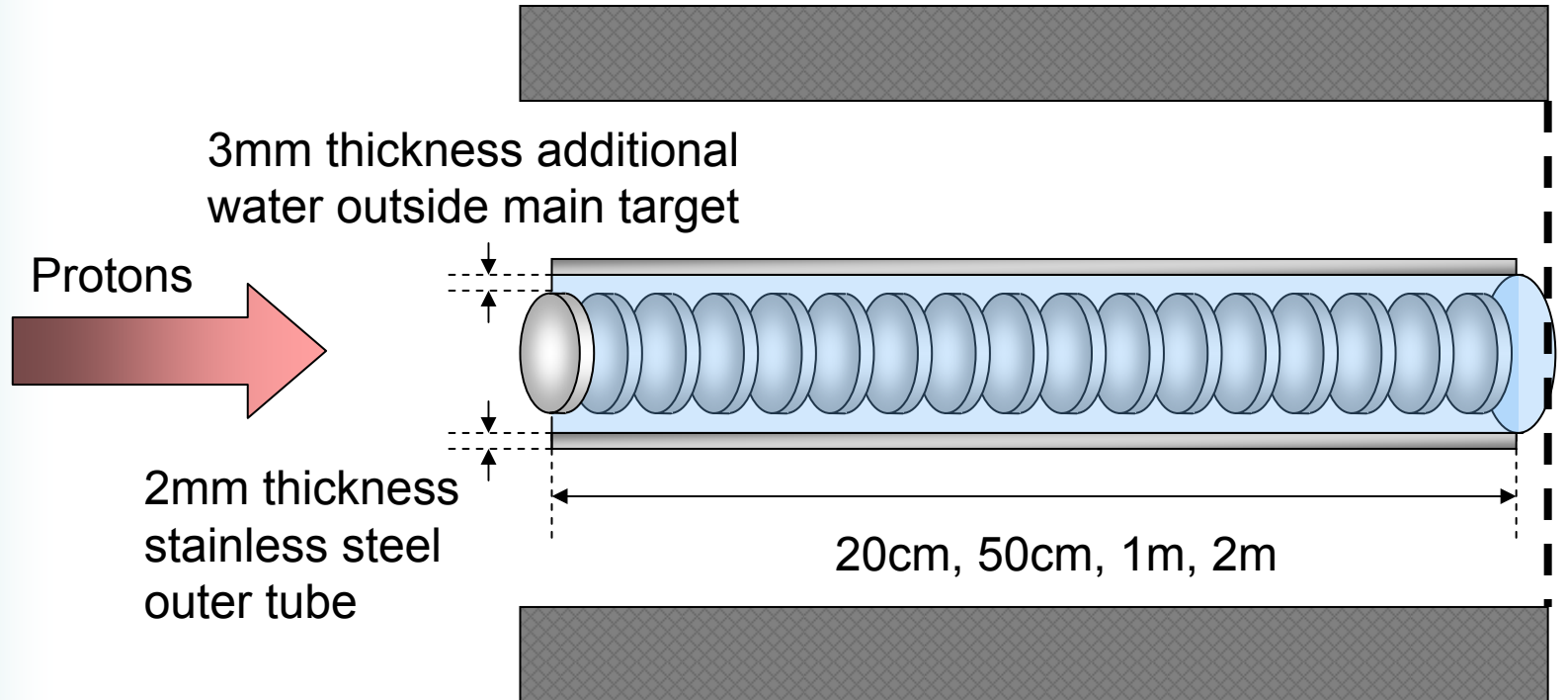

Tantalum “coin”, 2mm thick →  Water  100 coins in target for 20cm total Ta thickness

Modified Pion Yield

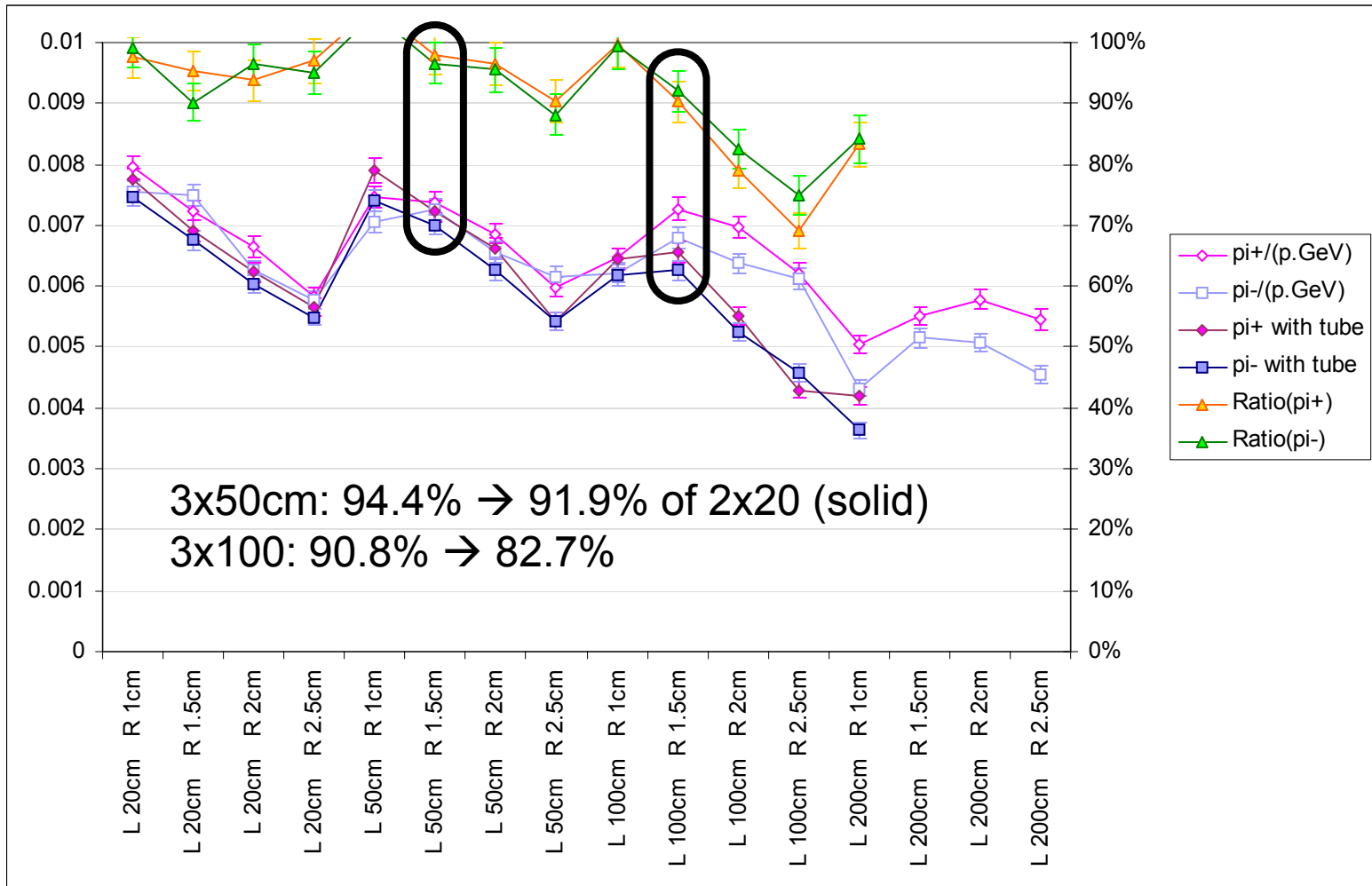

Amount of Heating

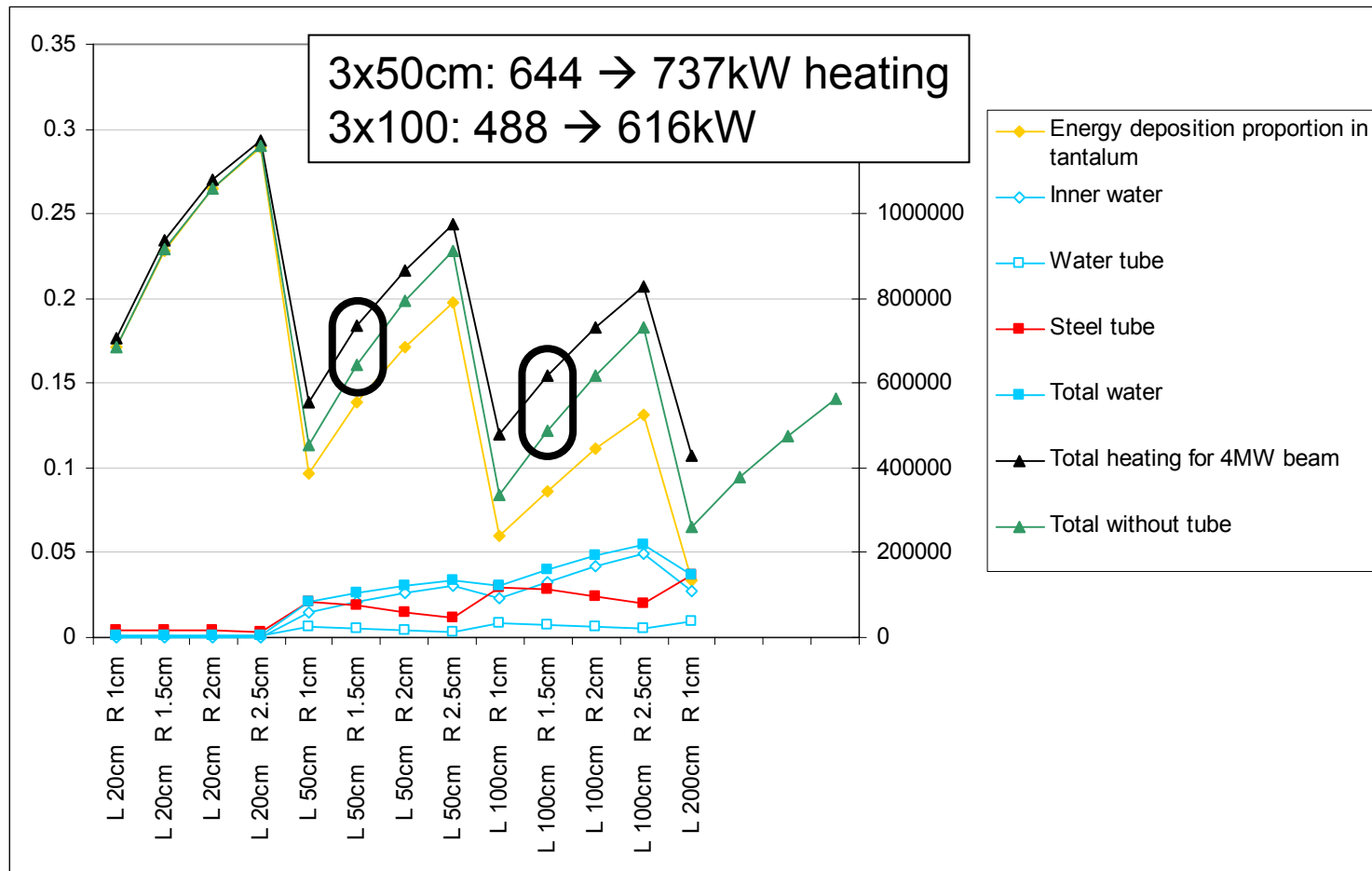

RMS of Useful Arrival Times

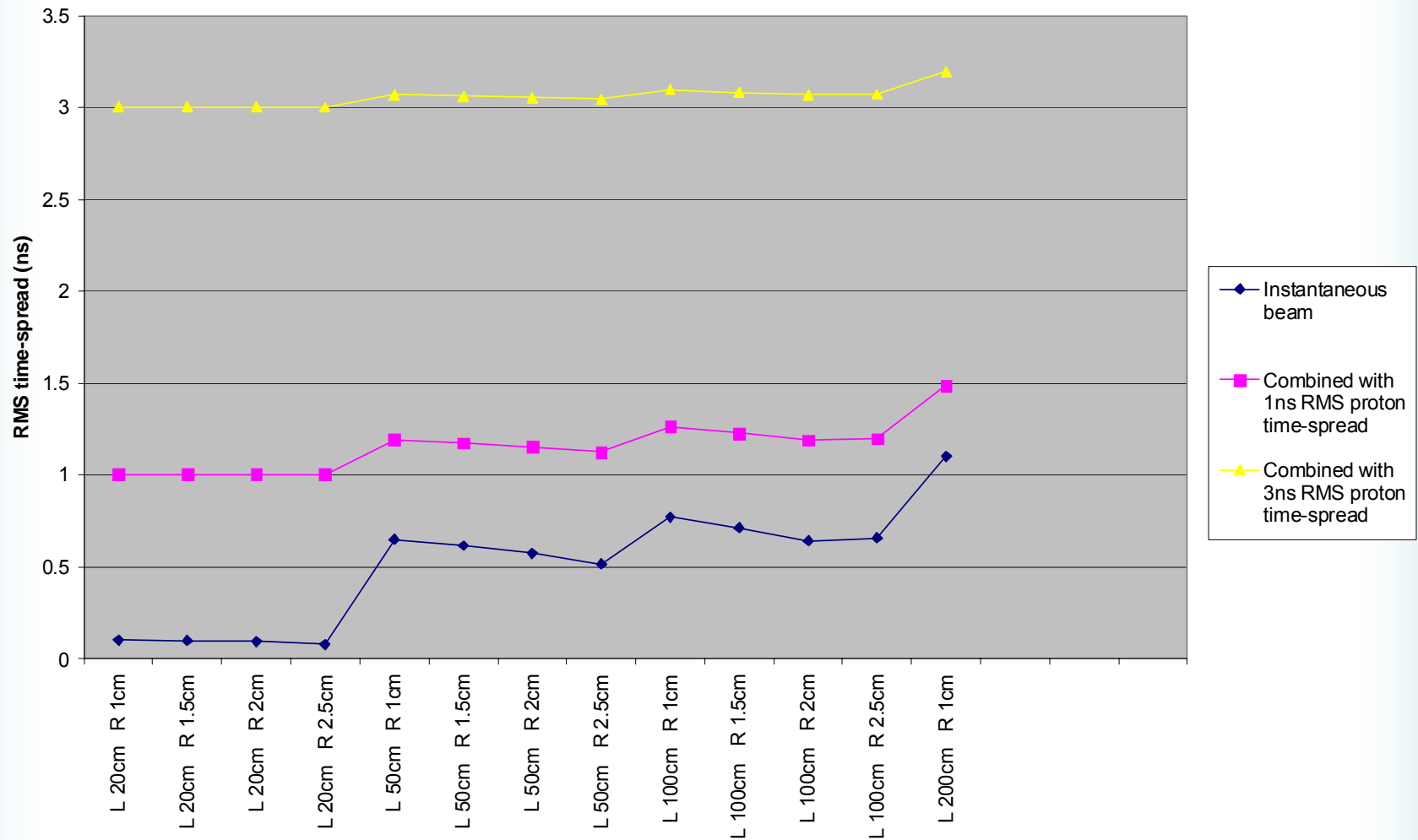

Conclusions

- The neutrino factory requirements do not seem to preclude a water-cooled target
 - Fast particle production targets can have a much lower % heat load than slow targets
- Does this also mean an SNS-style enclosed mercury target might work?
- Need to investigate in more depth to either verify or exclude these options