

Molecular dynamics with on-the-fly machine learning of quantum mechanical forces

James Kermode

Warwick Centre for Predictive Modelling
School of Engineering
University of Warwick
www.warwick.ac.uk/wcpm

Warwick Centre for Predictive Modelling Seminar Series
5th March 2015

Warwick Centre for Predictive Modelling

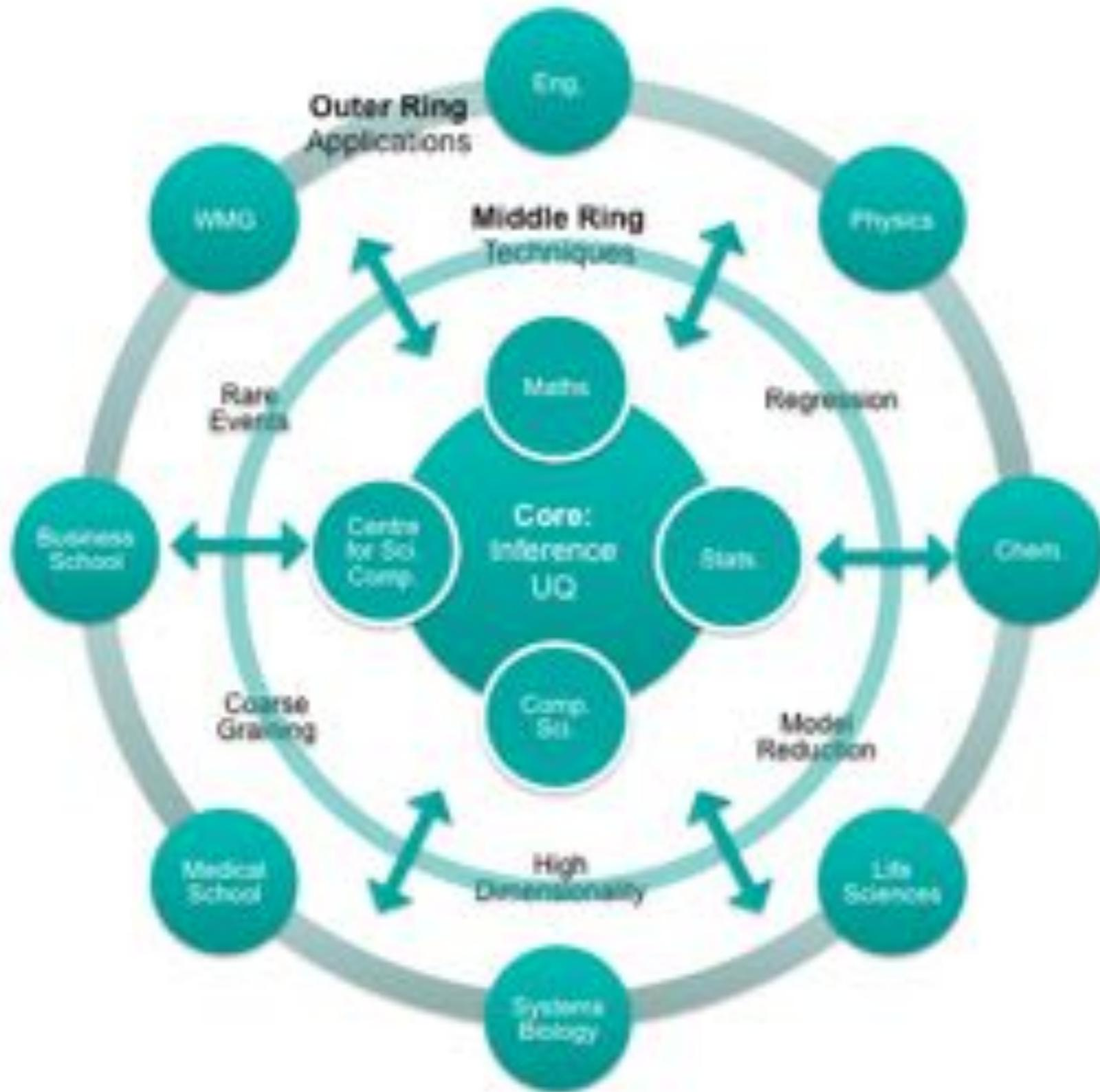

Multiscale Materials Modelling

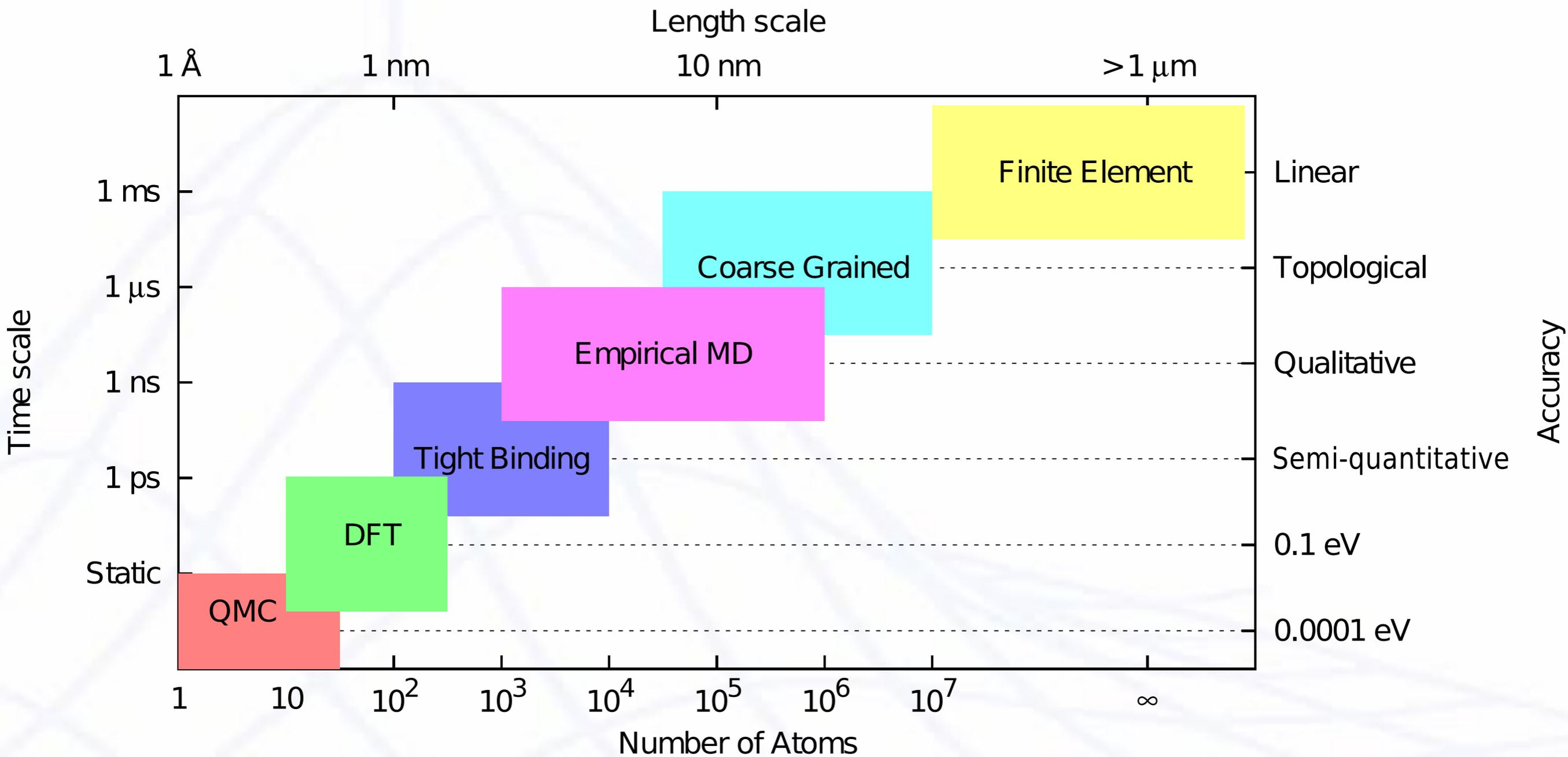

Accuracy & transferability

Materials failure process:
complex chemistry *and* large systems

Matching Atomistic and Continuum

Cracks in ideal brittle materials are atomically sharp

Divergence of stress field near a crack tip

$$\sigma \sim \frac{1}{\sqrt{r}}$$

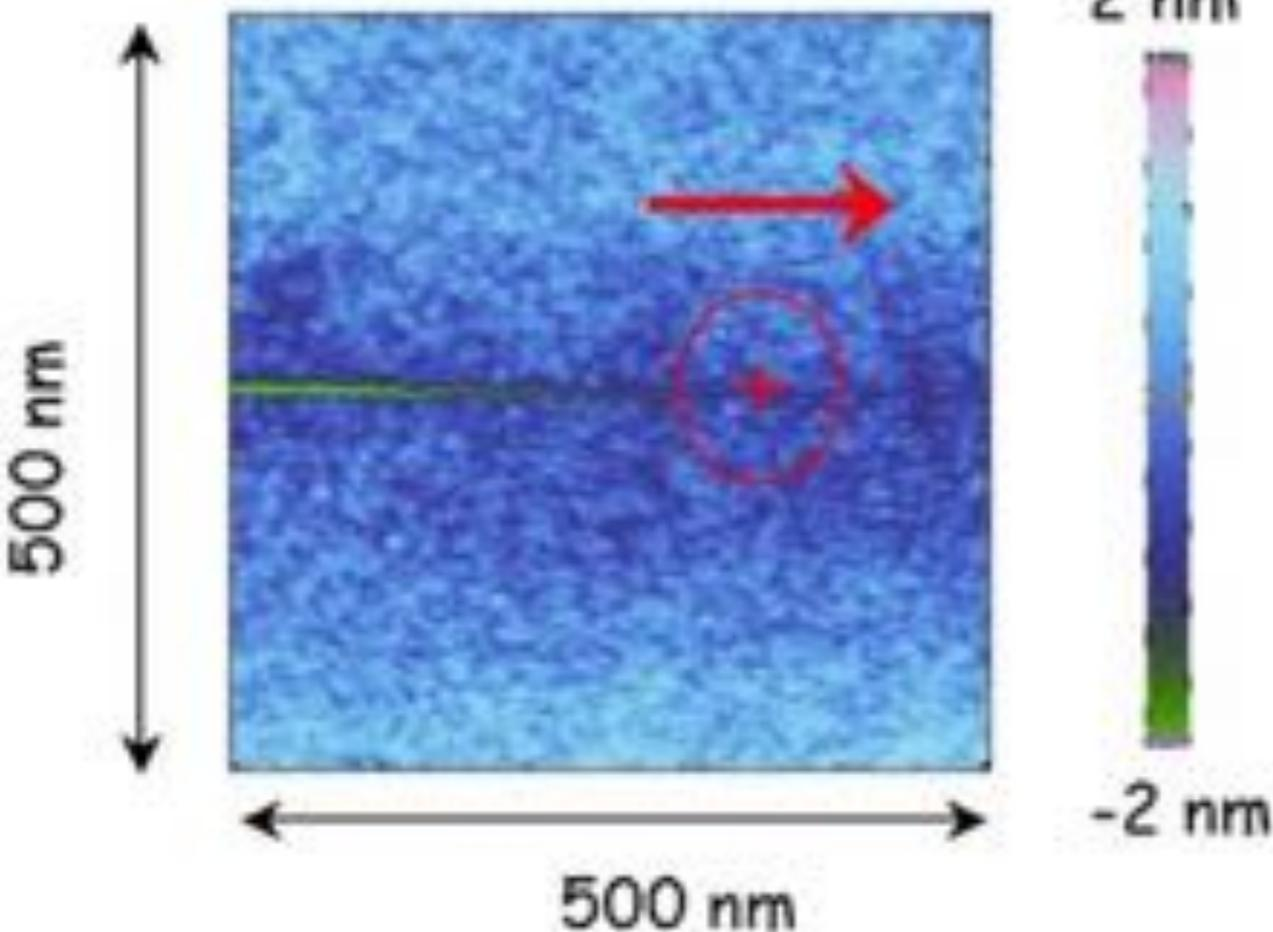

In situ AFM image of atomically sharp crack tip in silica (Image: C. Marlière)

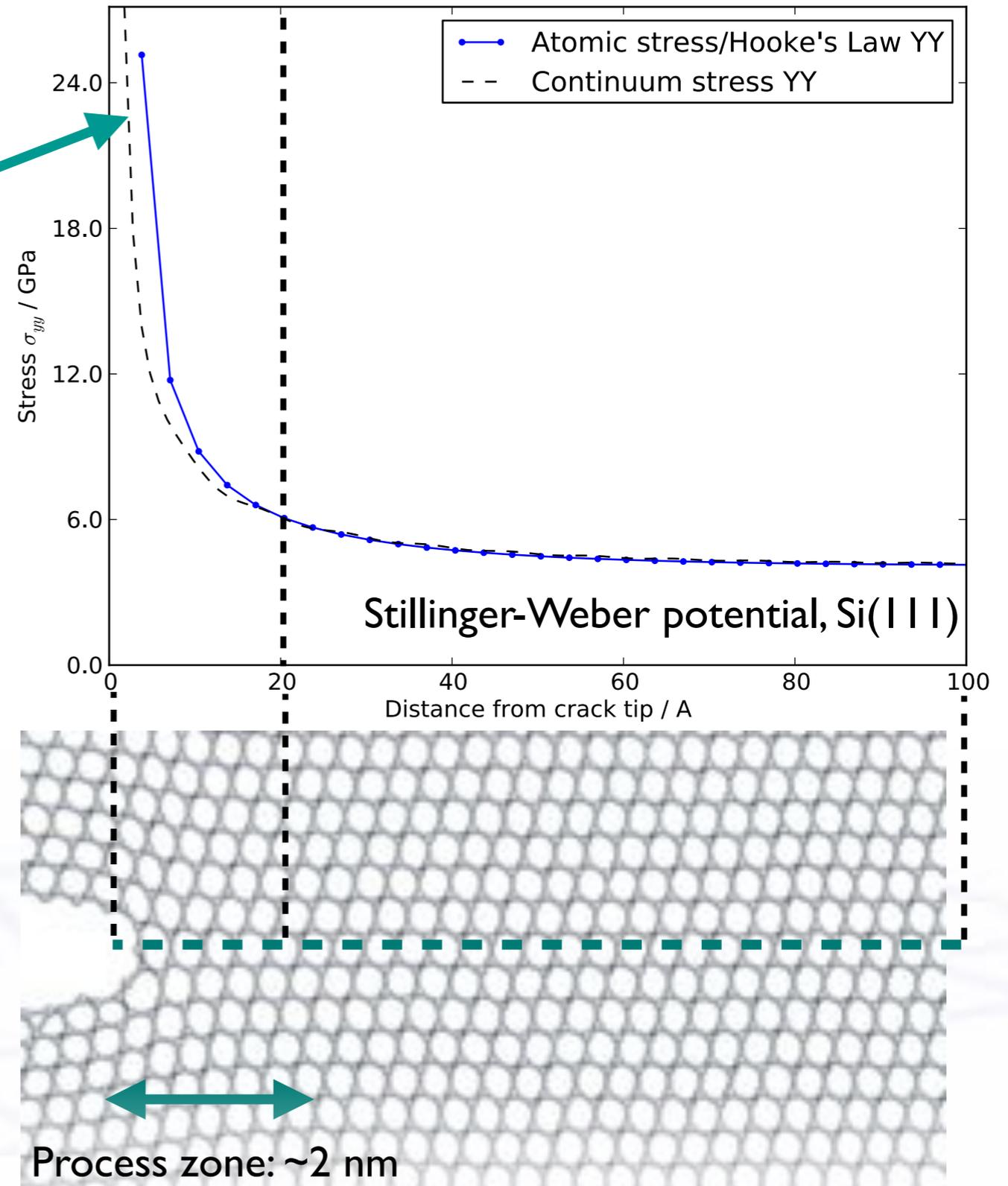

Multiscale Materials Modelling

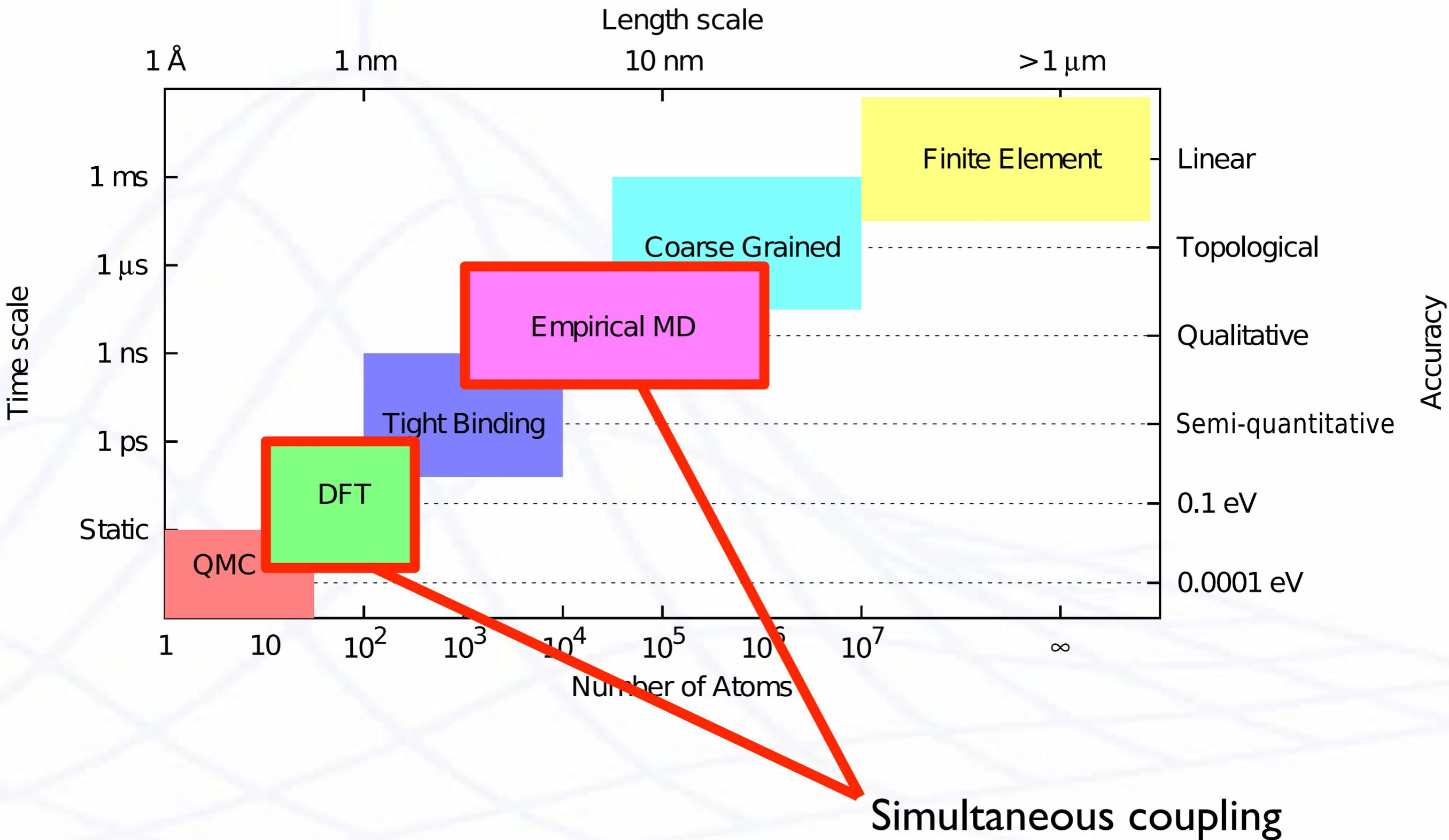

QM/MM – buffered force mixing

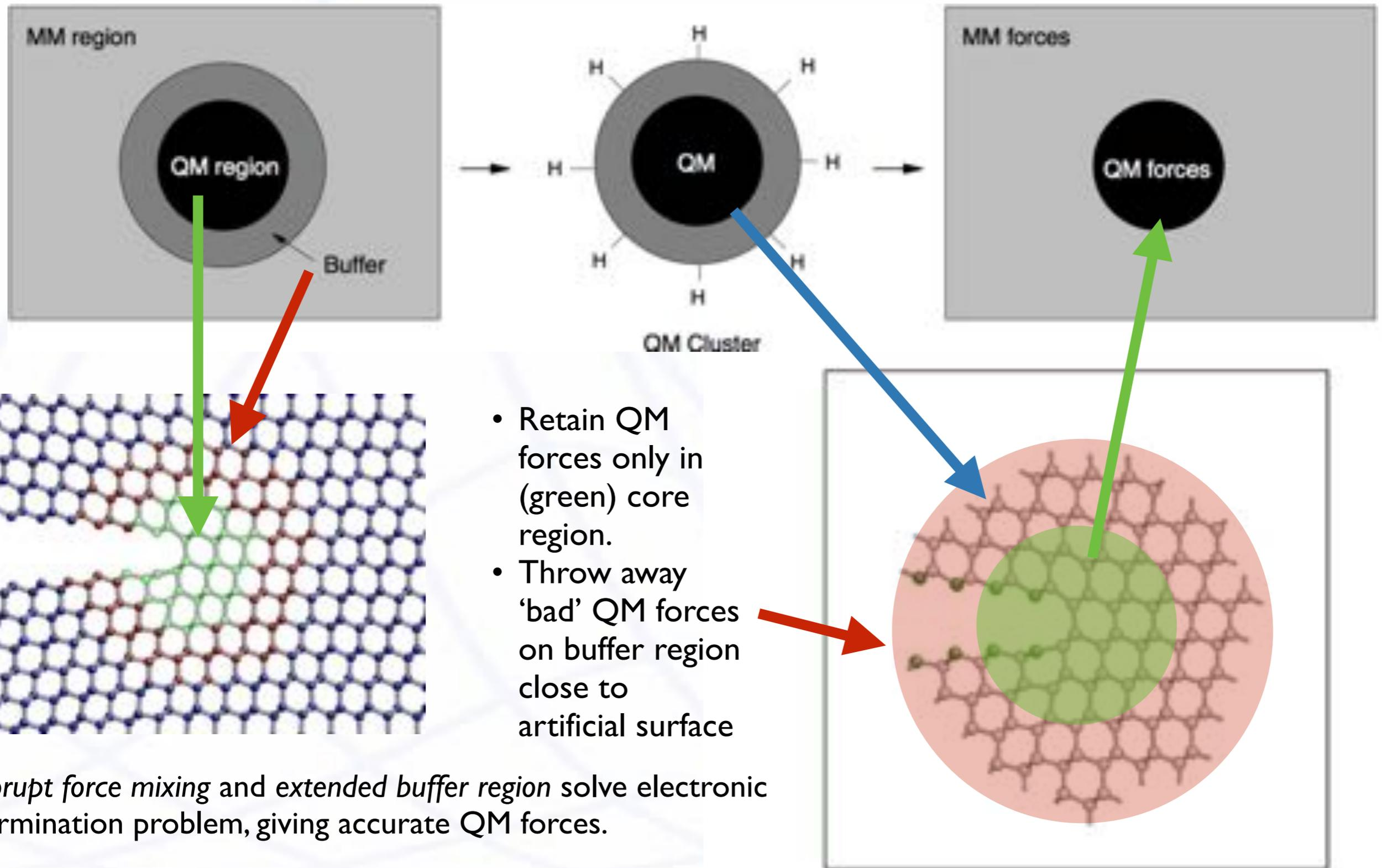

Abrupt force mixing and extended buffer region solve electronic termination problem, giving accurate QM forces.

QM/MM – buffered force mixing

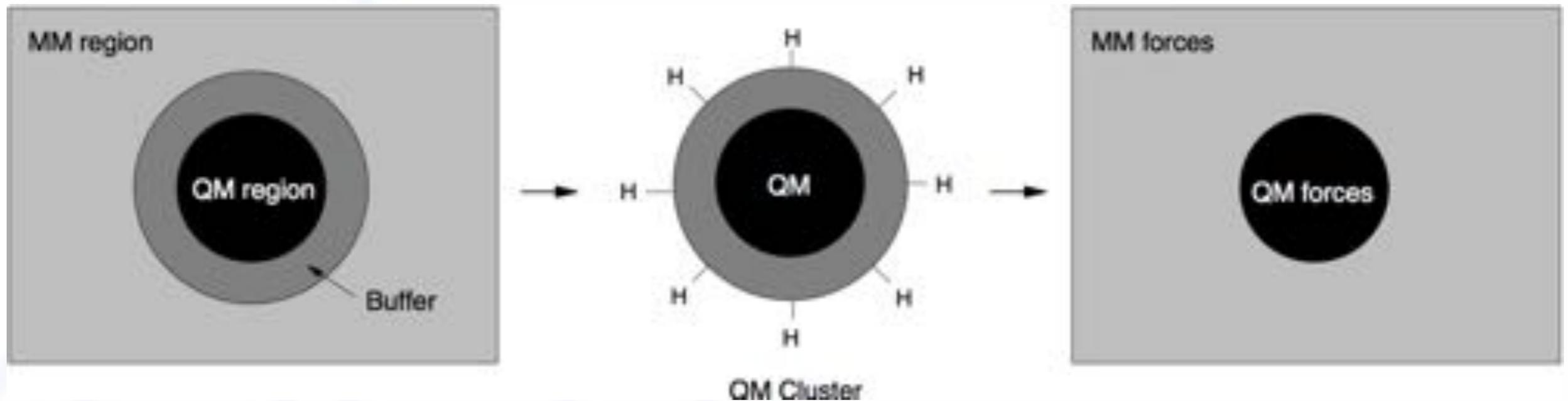

Covalent Materials

Oxides

Metals

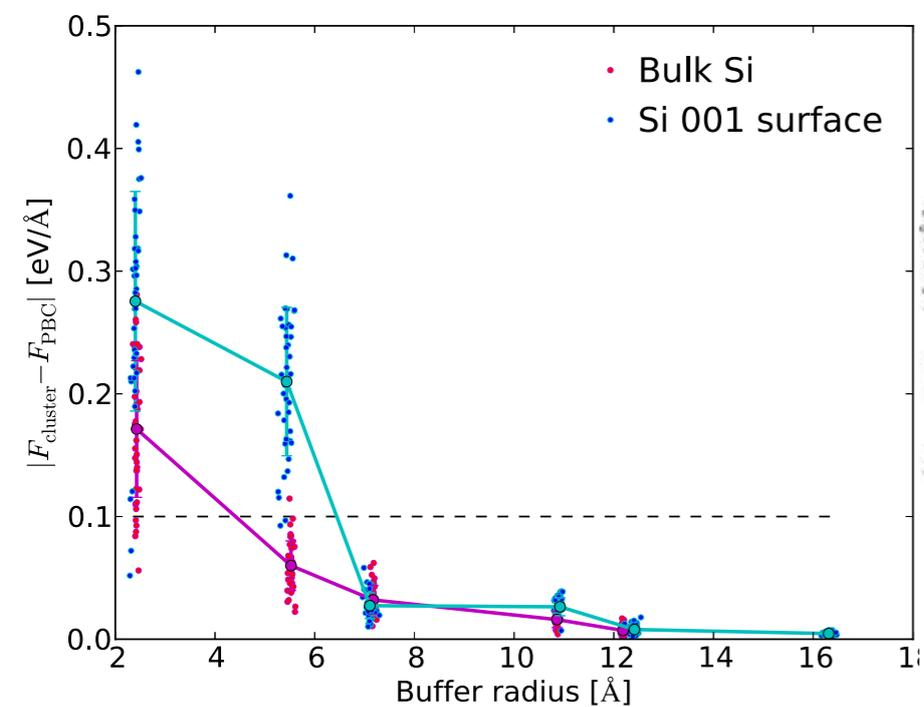

Silicon bulk and surface ~ 7 Å

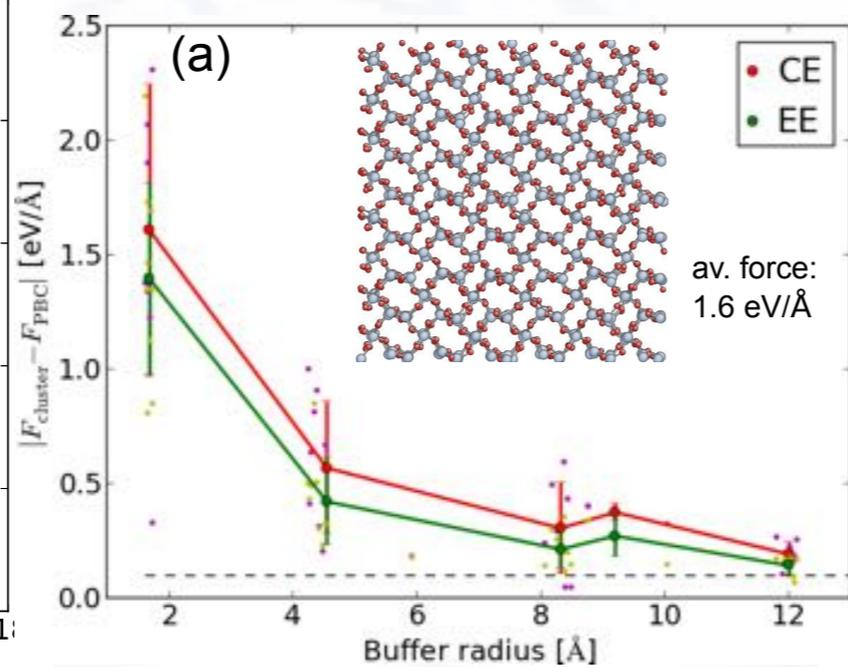

Silica (quartz, amorphous) ~ 10 Å

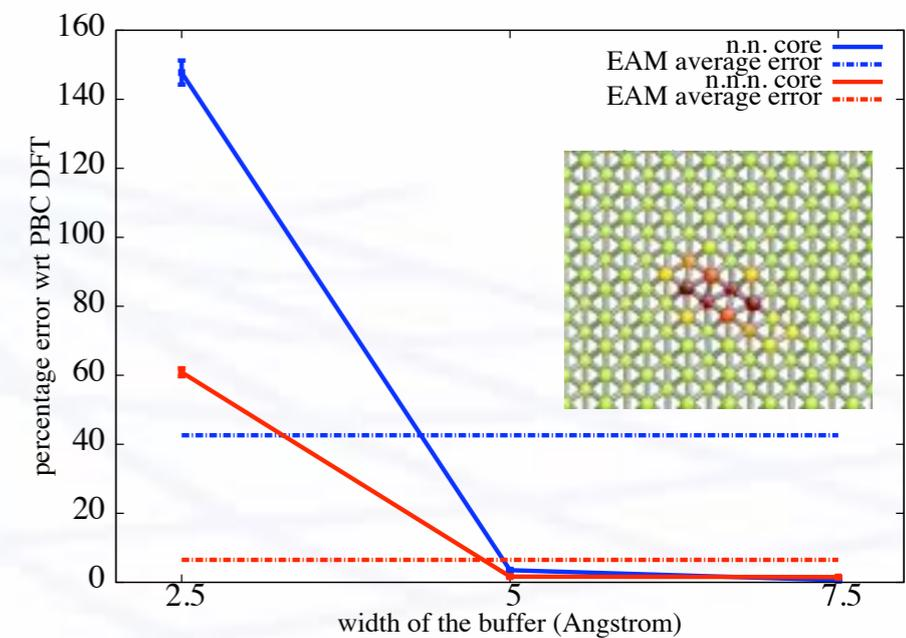

Dislocation core in Ni ~ 5 Å

'Learn on the Fly' scheme

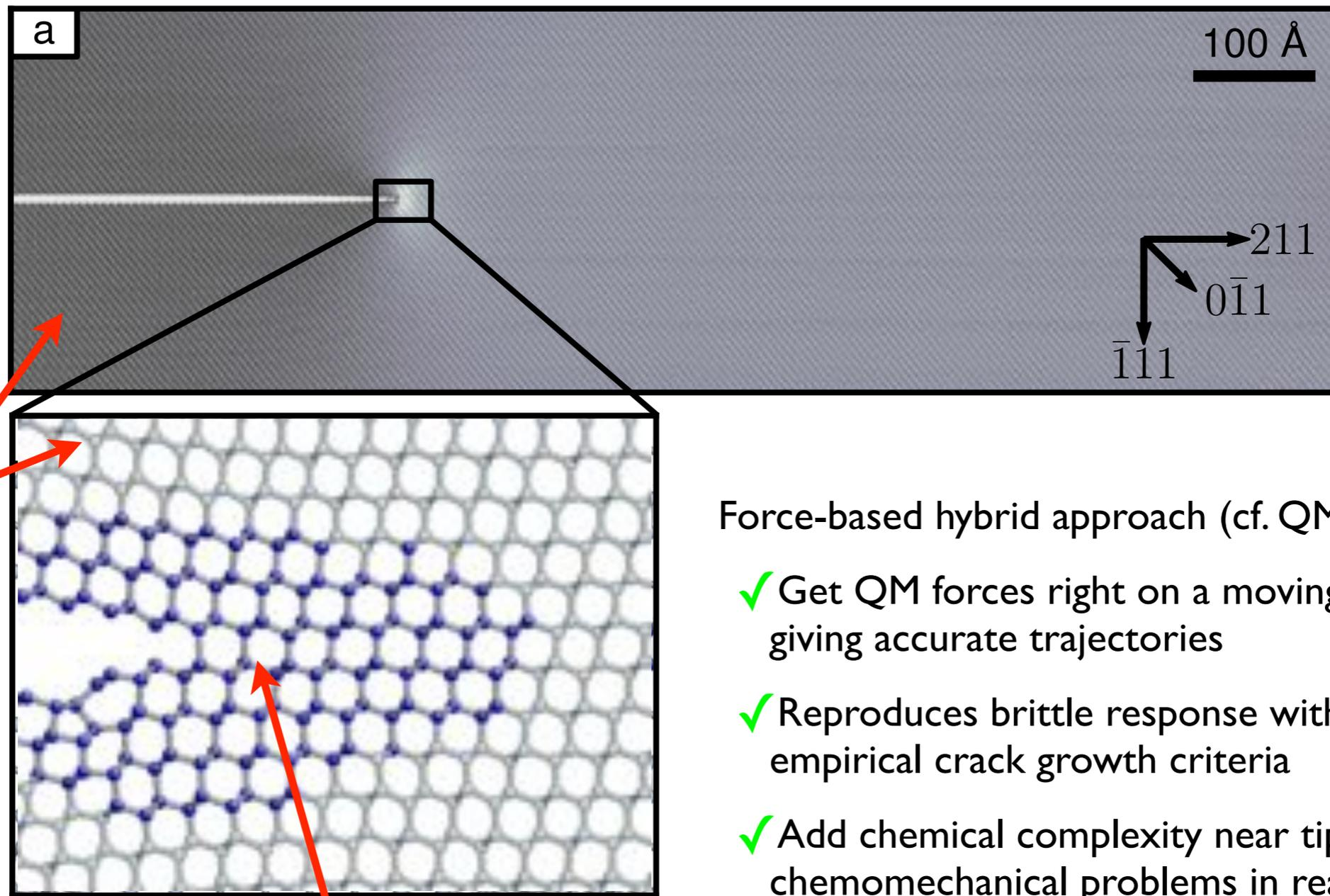

Molecular
Mechanics
(empirical,
fast)

Force-based hybrid approach (cf. QM/MM)

- ✓ Get QM forces right on a moving region, giving accurate trajectories
- ✓ Reproduces brittle response without any empirical crack growth criteria
- ✓ Add chemical complexity near tip: wide range of chemomechanical problems in reach

Quantum Mechanics
(accurate, slow)

Code: <http://www.libatoms.org>

Recent Chemomechanical Applications

Dynamical instabilities in Si

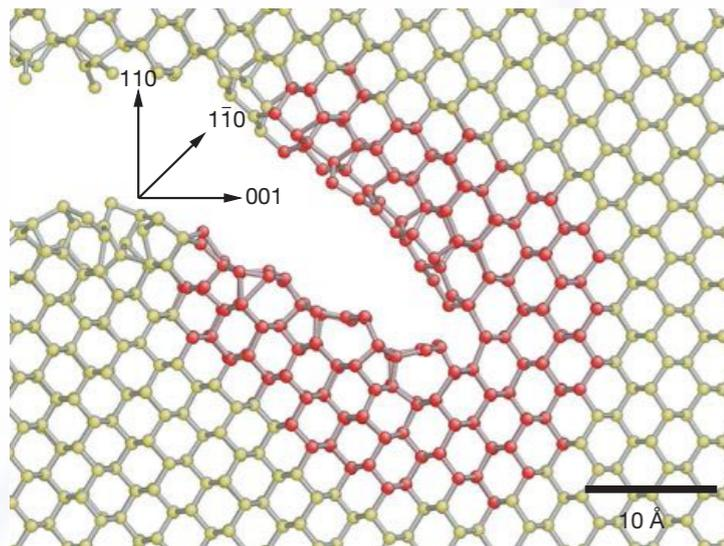

JR Kermode et. al.
Nature 455 1224 (2008)

H induced 'SmartCut'

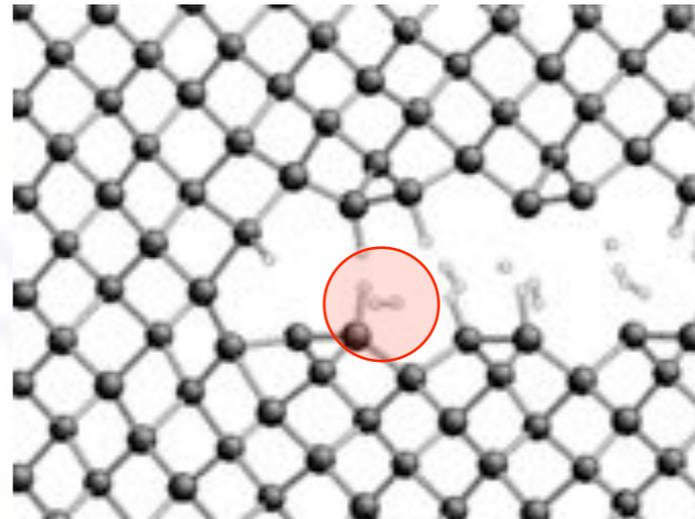

G Moras, L Ciachhi, C Elsässer,
P Gumbsch and A De Vita
Phys. Rev. Lett. 105, 075502 (2010)

Crack-dislocation interactions

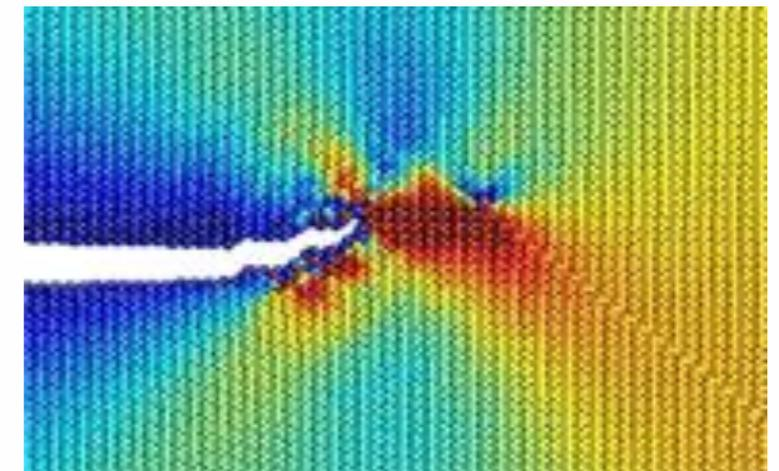

C Gattinoni, JR Kermode and
A De Vita, In prep

Three dimensional effects

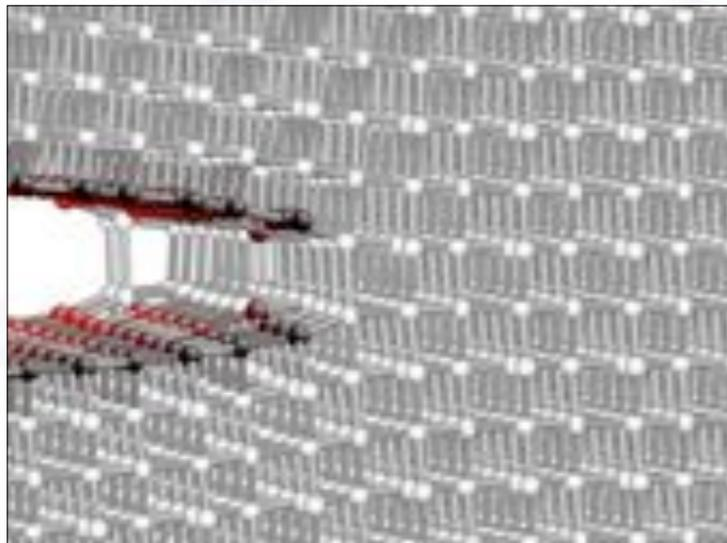

JR Kermode, A. Glazier, G Kovel, L Pastewka,
G Csányi, D Sherman and A. De Vita, In prep

Crack-impurity scattering

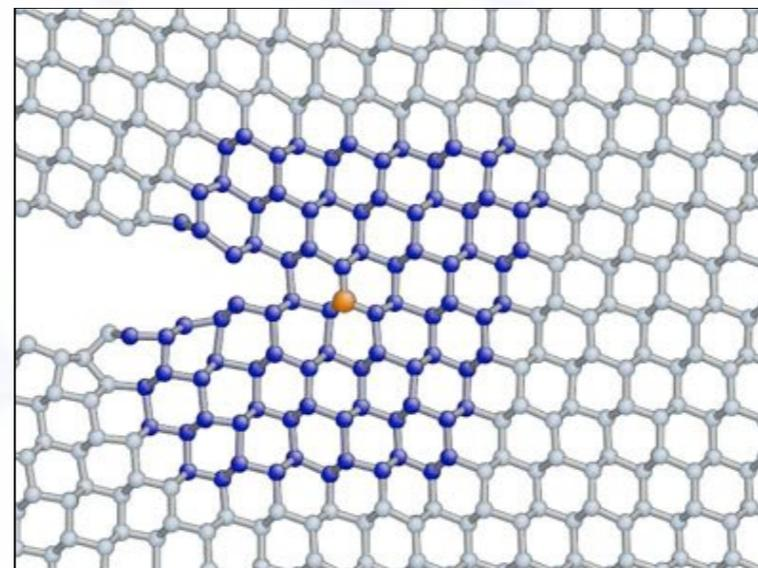

JR Kermode, L Ben-Bashat, F Atrash,
JJ Cilliers, D Sherman and A. De Vita.,
Nat. Commun. 4 2441 (2013)

Stress corrosion cracking

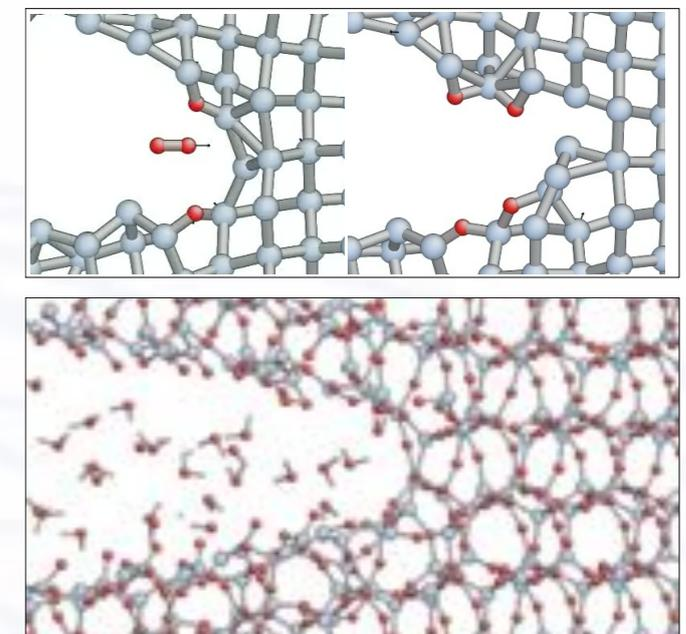

A Glazier, G Peralta, JR Kermode,
A De Vita and D Sherman,
Phys. Rev. Lett, 112 115501 (2014).

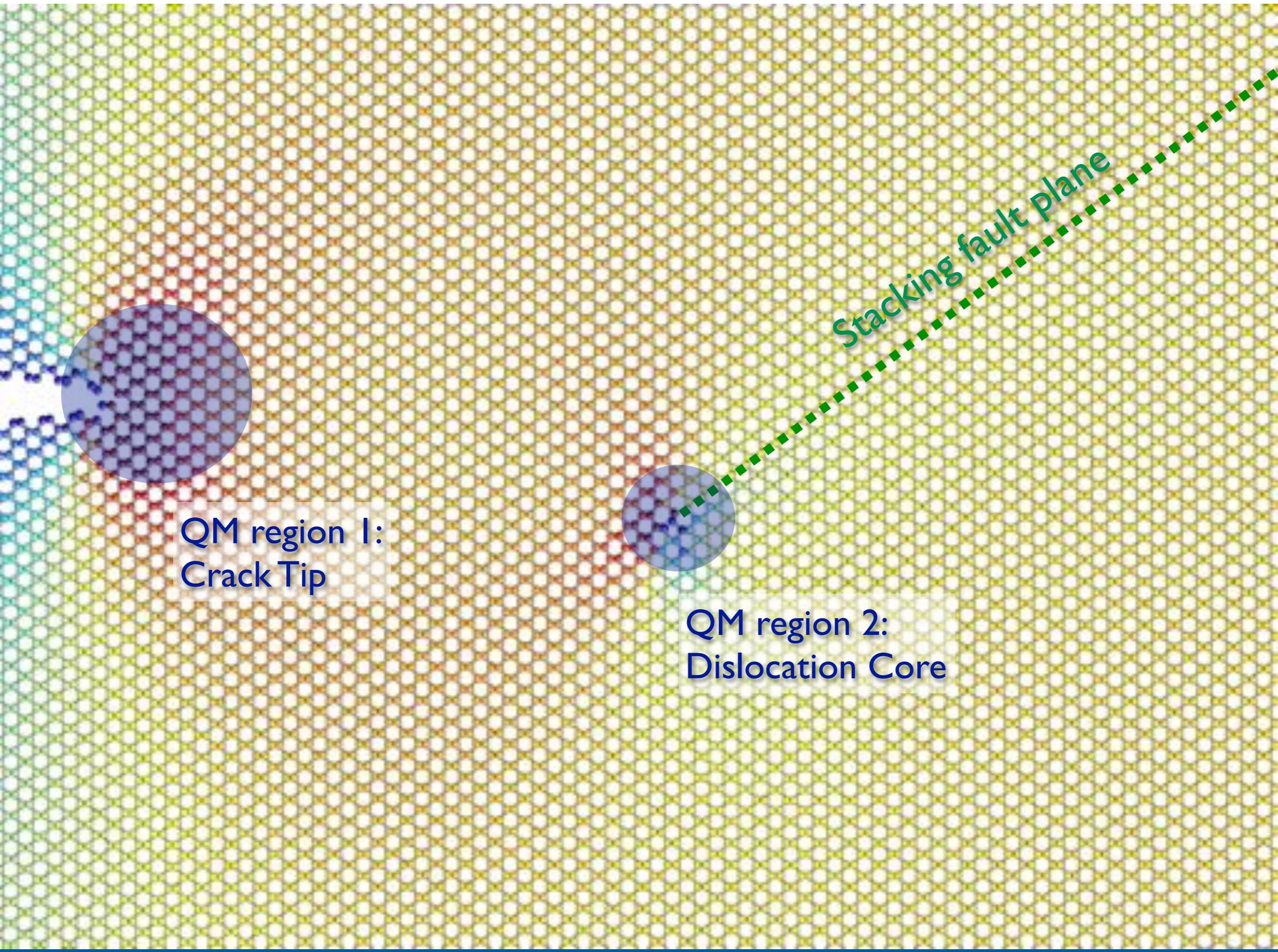

Stacking fault plane

QM region 1:
Crack Tip

QM region 2:
Dislocation Core

Crack/dislocation – coarse-graining

Dislocation core above crack

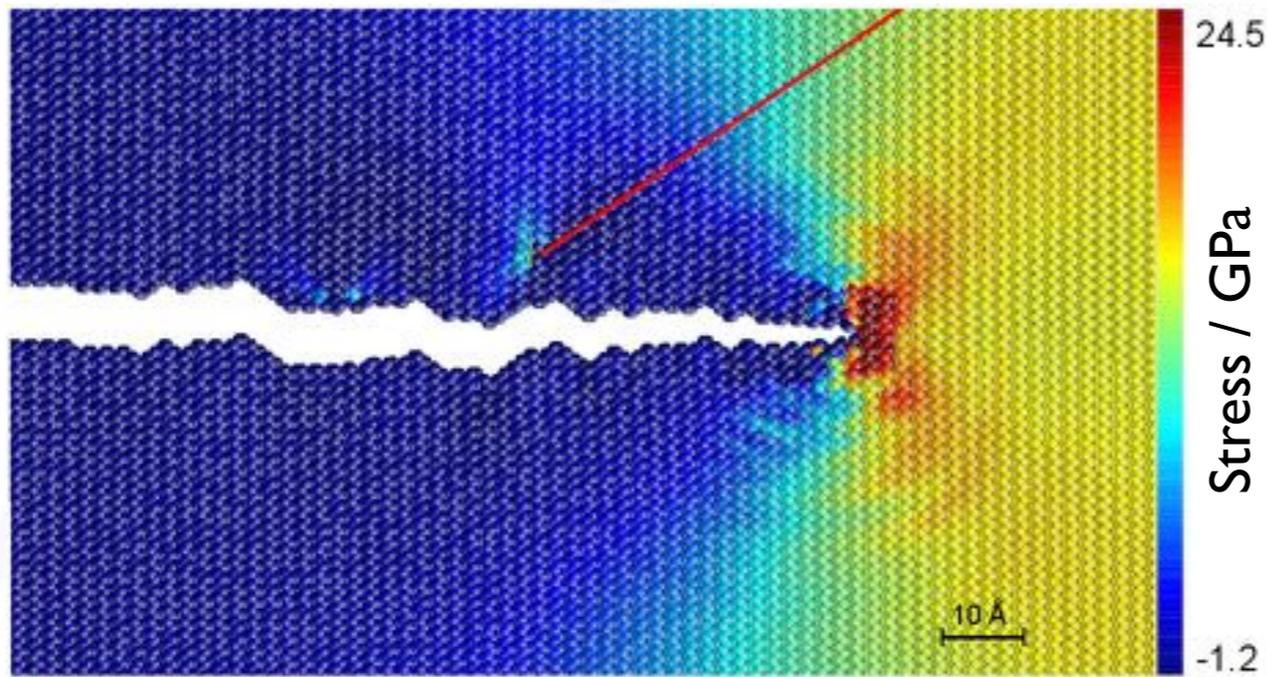

Dislocation core below crack

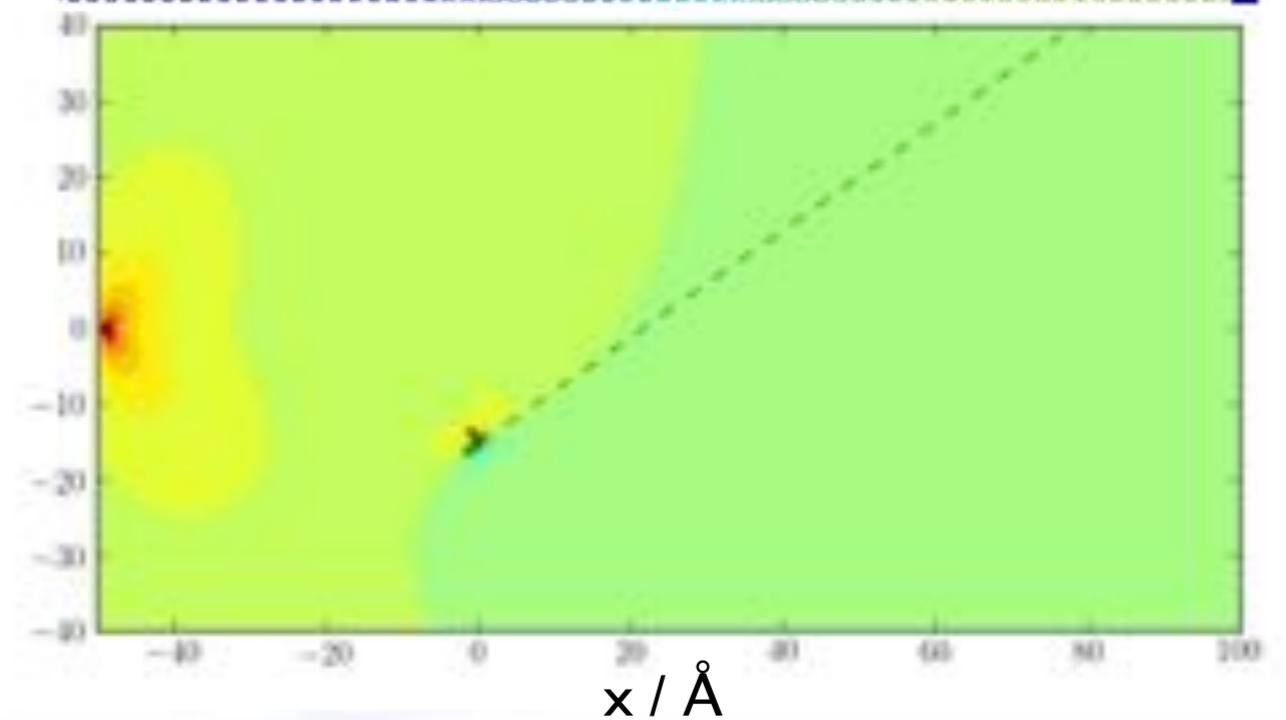
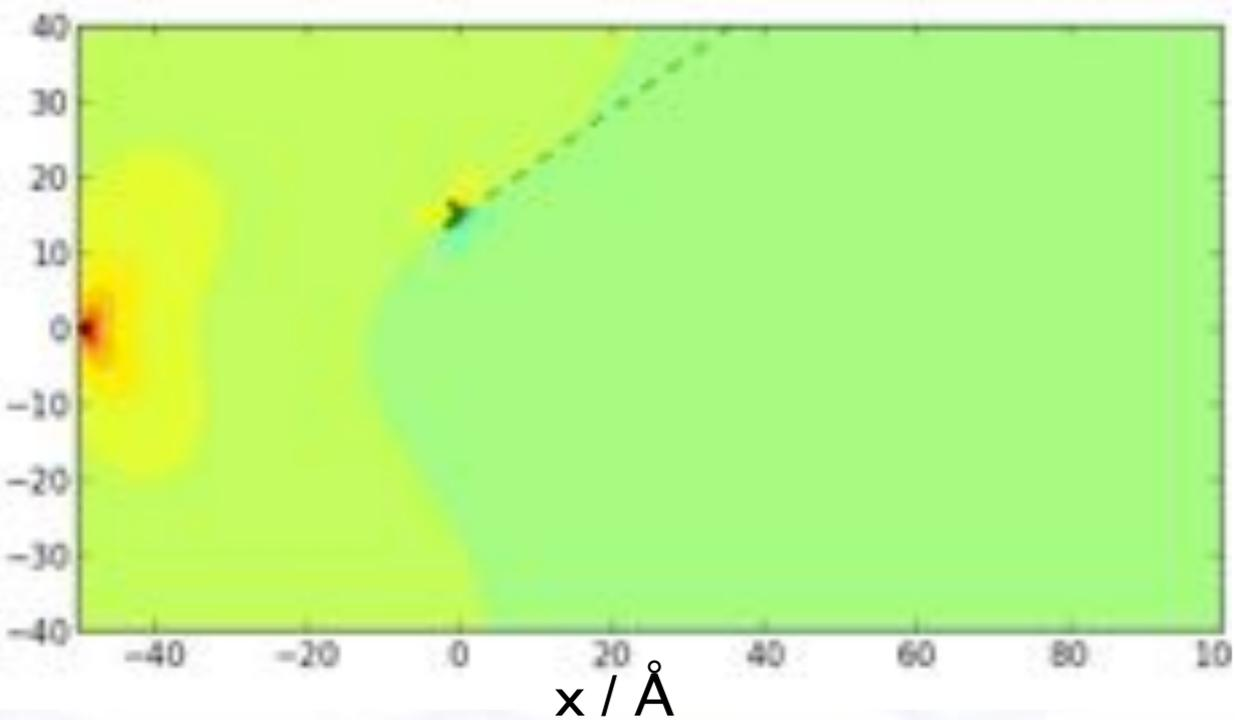
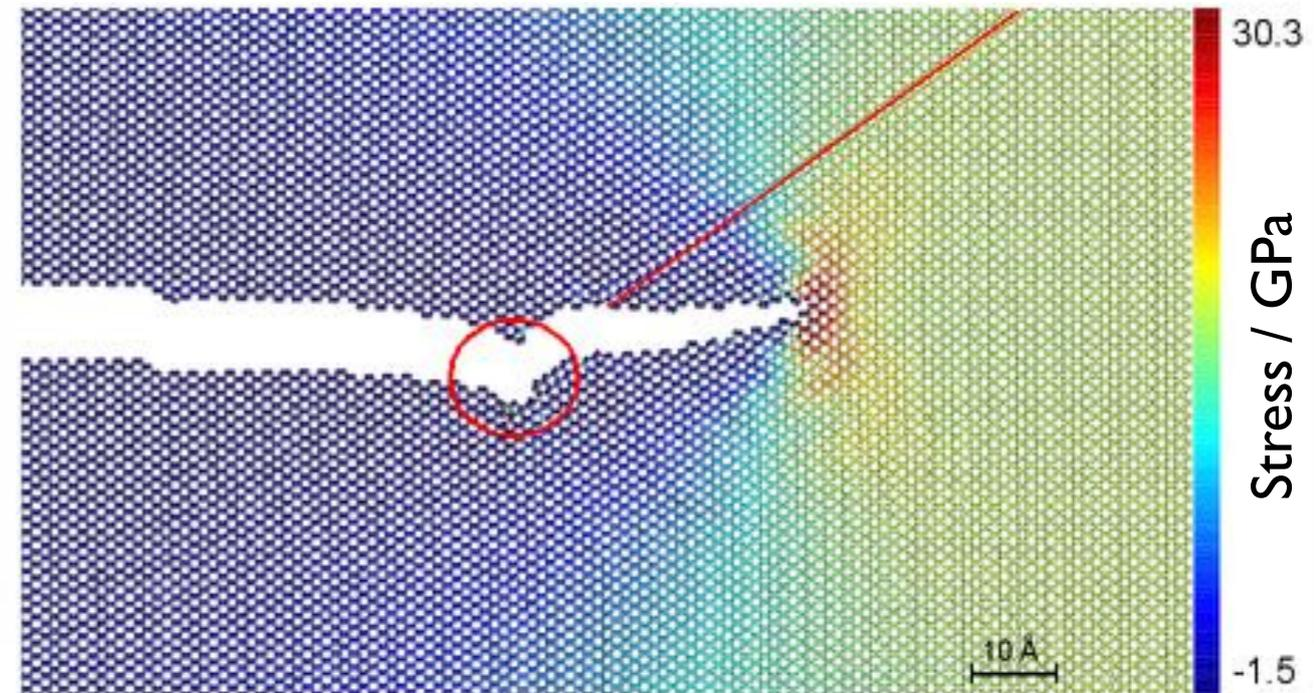

Quantifying loss of information during coarse-graining: uncertainty propagation from atomistic to continuum

Microstructural Uncertainty

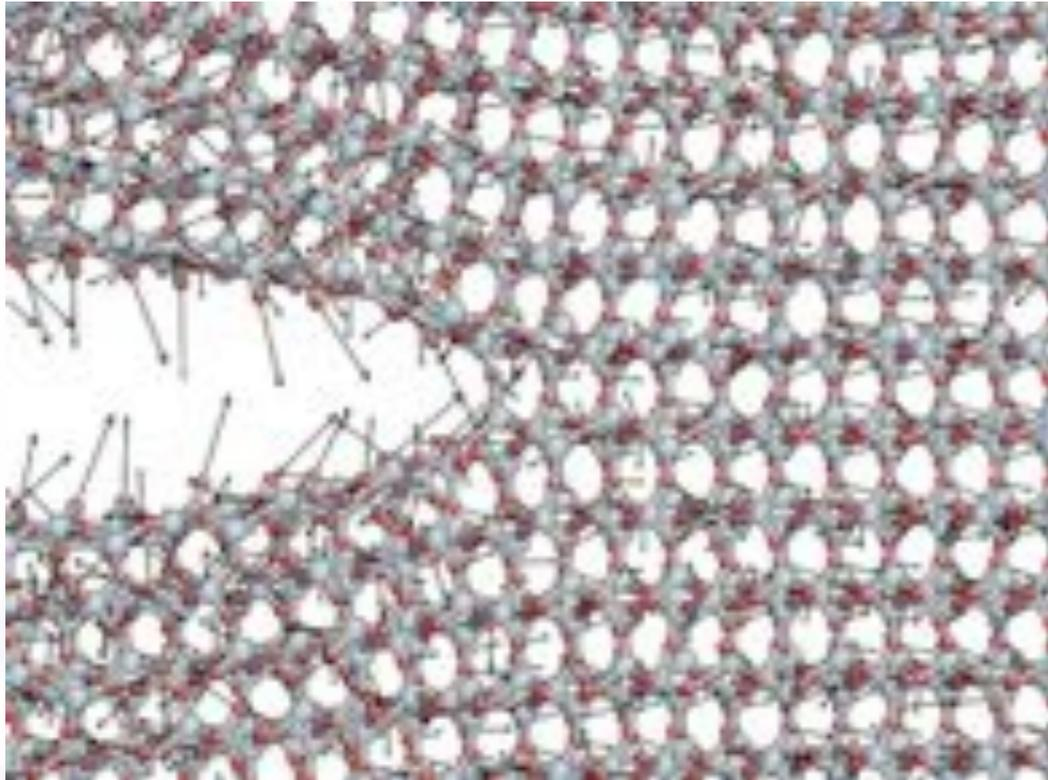

- Most of our work so far has only considered *deterministic* materials failure problems
- *Stochastic* microstructural effects are also extremely important
- e.g. fracture in glass, a prototypical amorphous material, where microstructural variation plays key role in determining fracture response

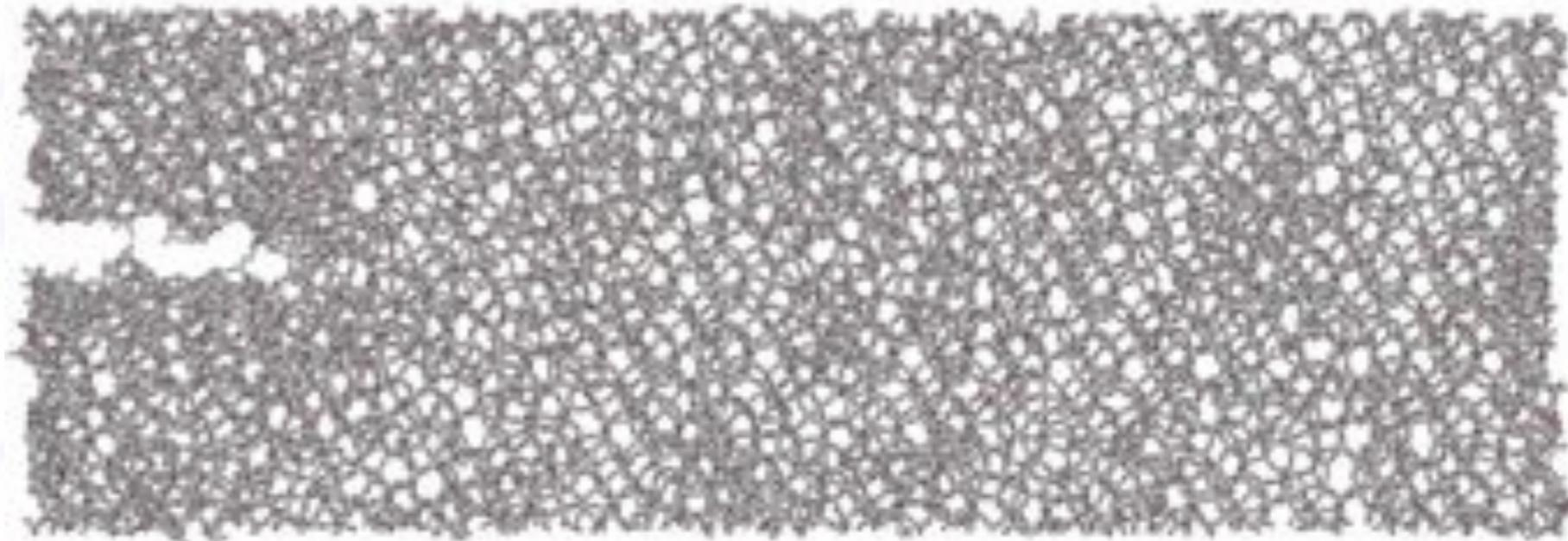

Goal: average over representative microstructural configurations to produce effective mean-field response. Probabilistic ‘error bars’ essential.

Target Application Areas

Covalent Materials

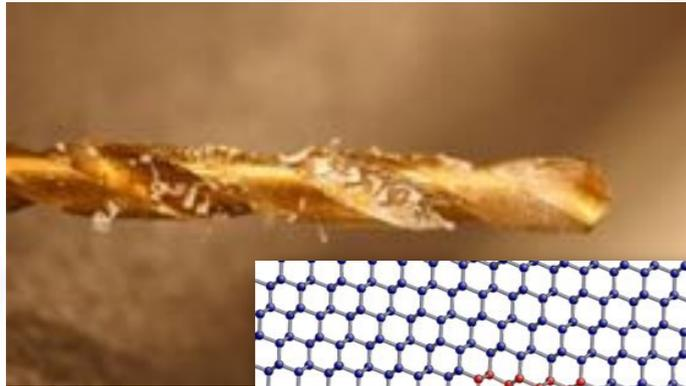

Diamond

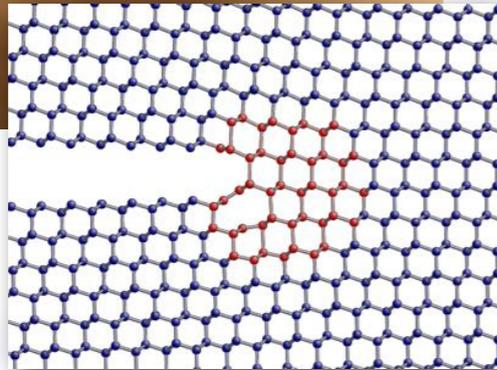

Oxides



Rocks

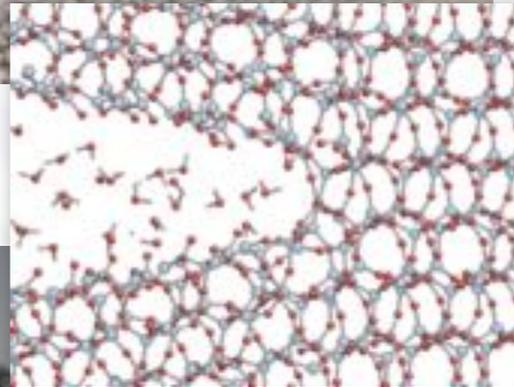

Metals



Superalloys

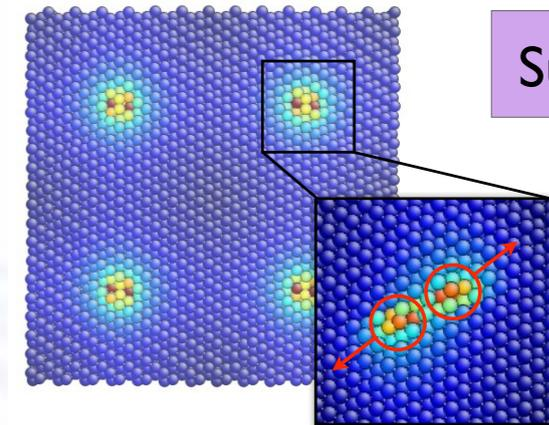

HEmS

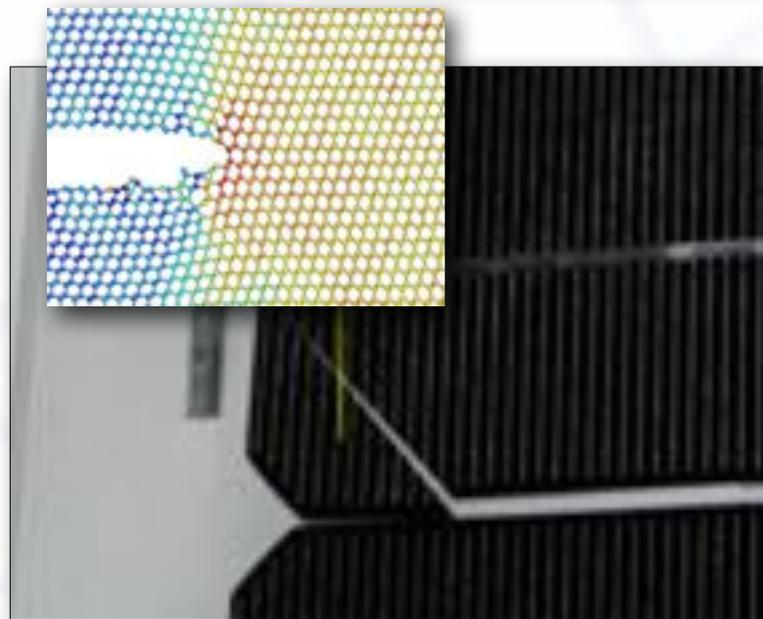
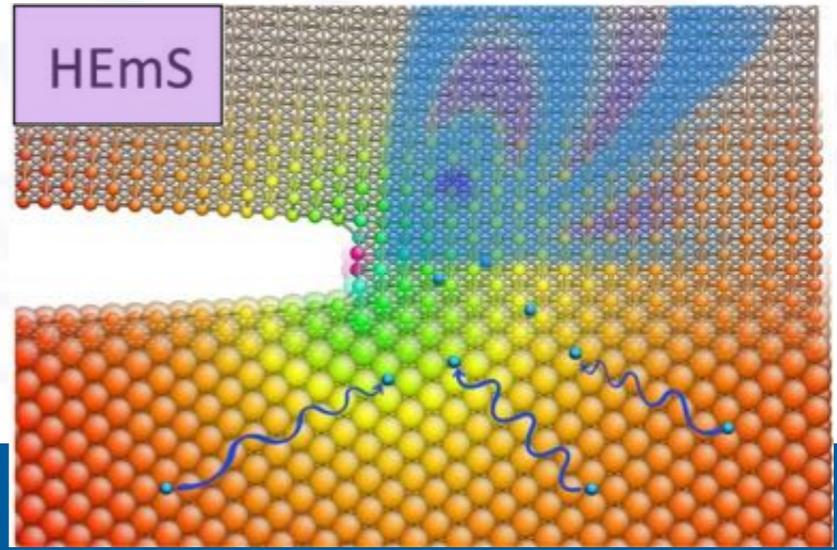

Silicon Photovoltaics

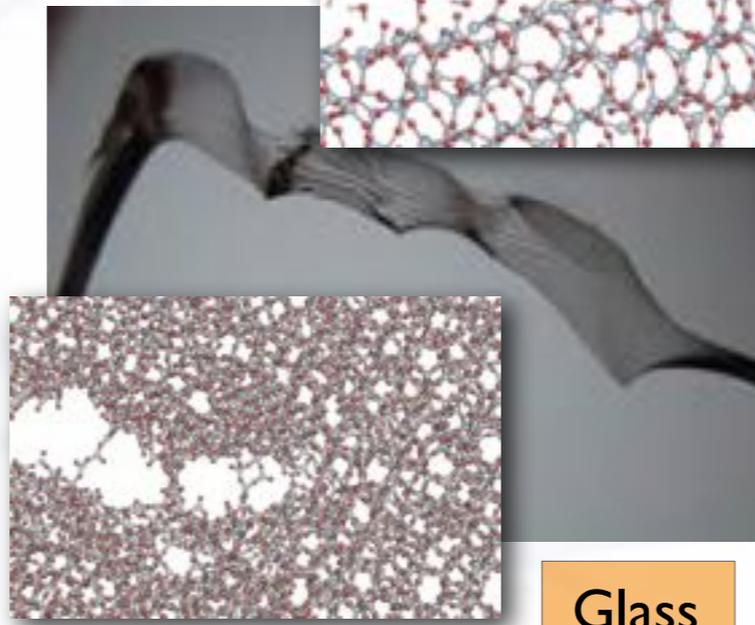

Glass

HPC Scalability

- Force-mixing allows work of QM calculations to be distributed
- Automatically split large QM regions into smaller convex clusters by graph partitioning
- Individual QM calculations run in parallel on ~1024 cores each
- Scalable up to ~100,000 core Petascale machines

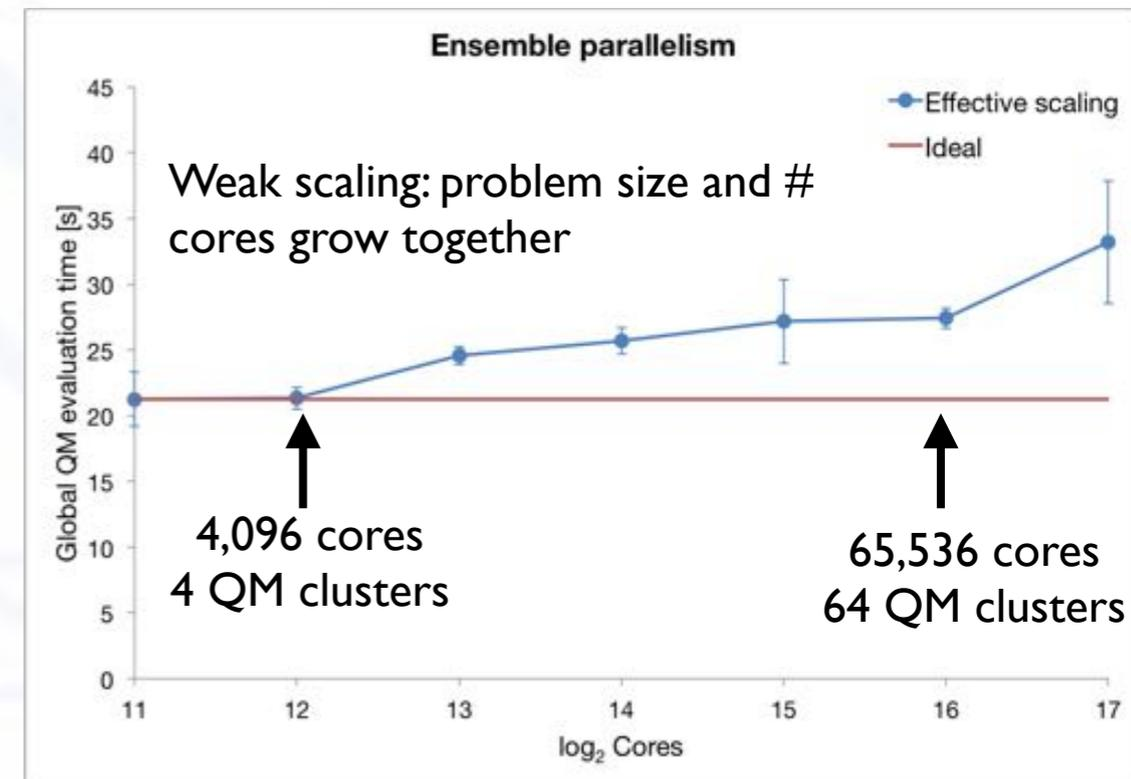
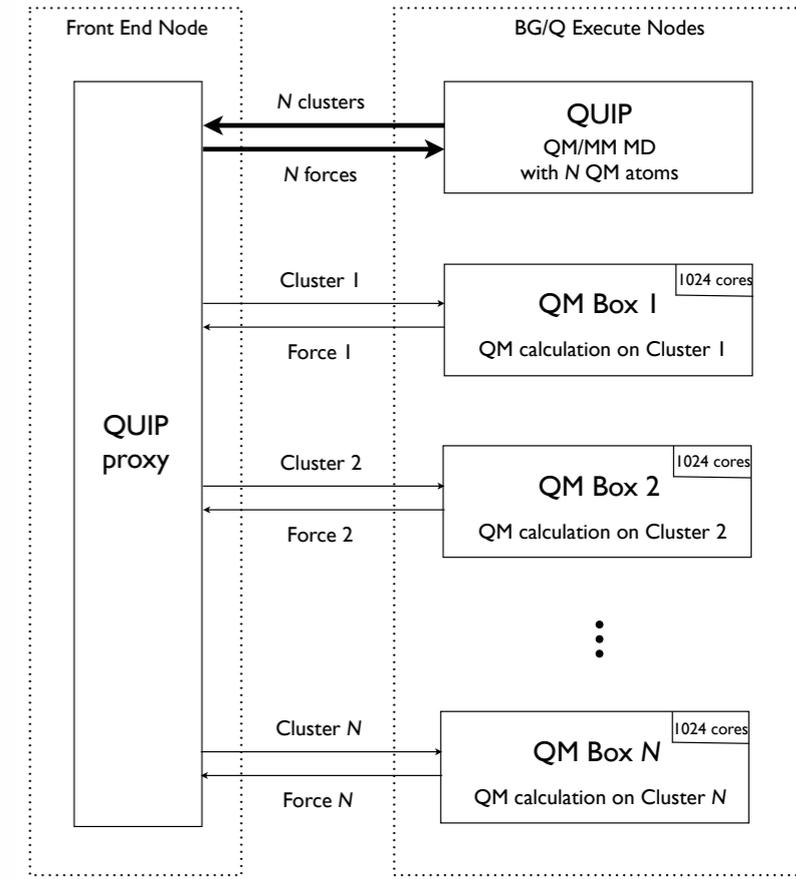
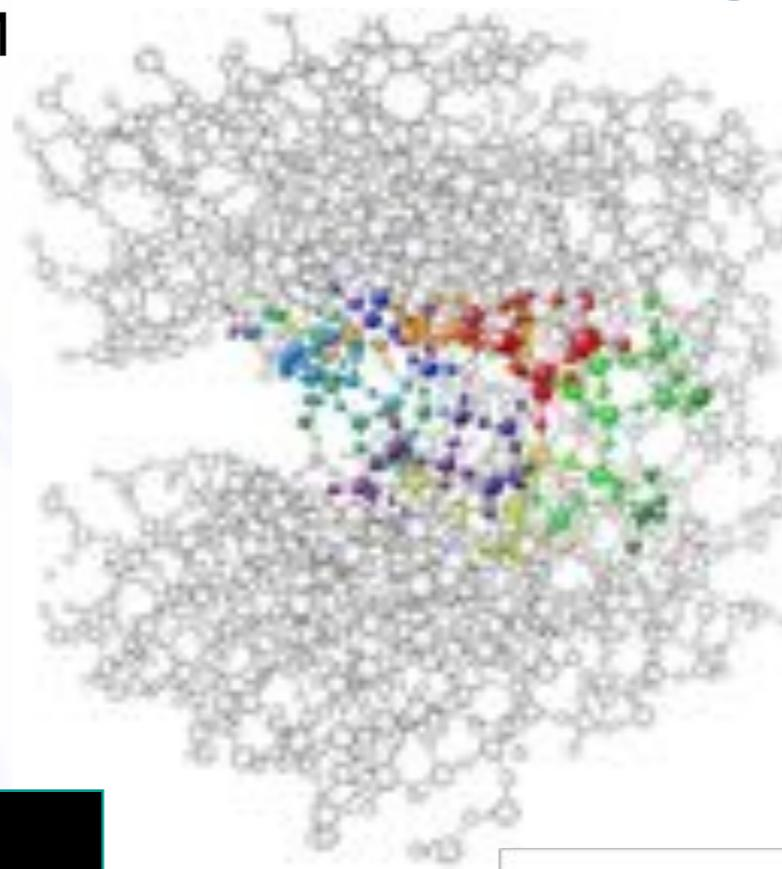

'Learn on the Fly' predictor/corrector

'Learn on the Fly' scheme adds 'springs' tuned to reproduce QM forces

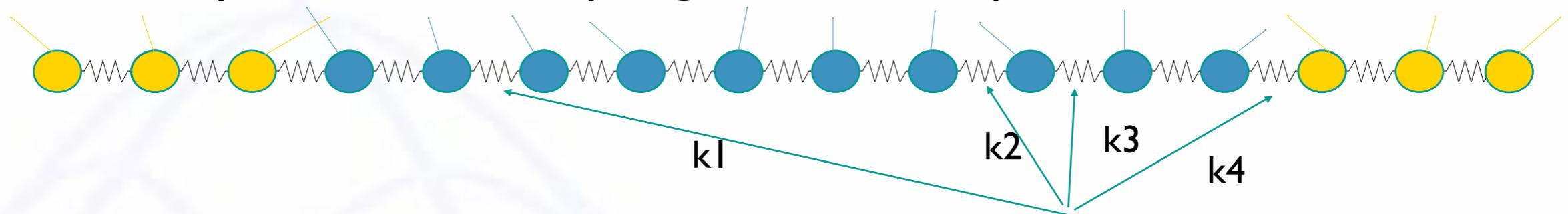

$$U(\mathbf{R}) = U_{classical}(\mathbf{R}) + \sum_{\text{springs } n} \alpha_n r_n$$

LOTF vs. buffered force mixing:

- ✓ Both give correct trajectories
- ✓ LOTF allows speed up with predictor/corrector dynamics

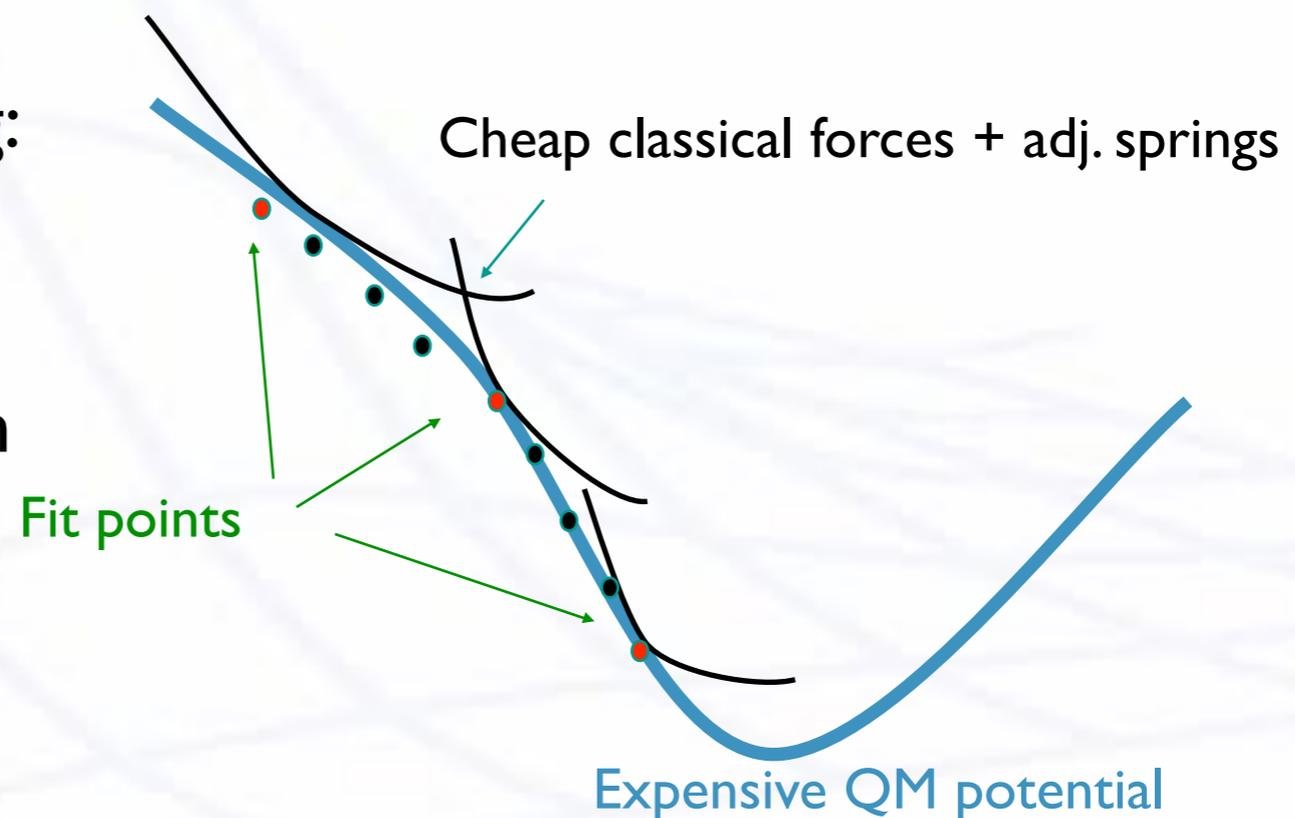

'Learn on the Fly' predictor/corrector

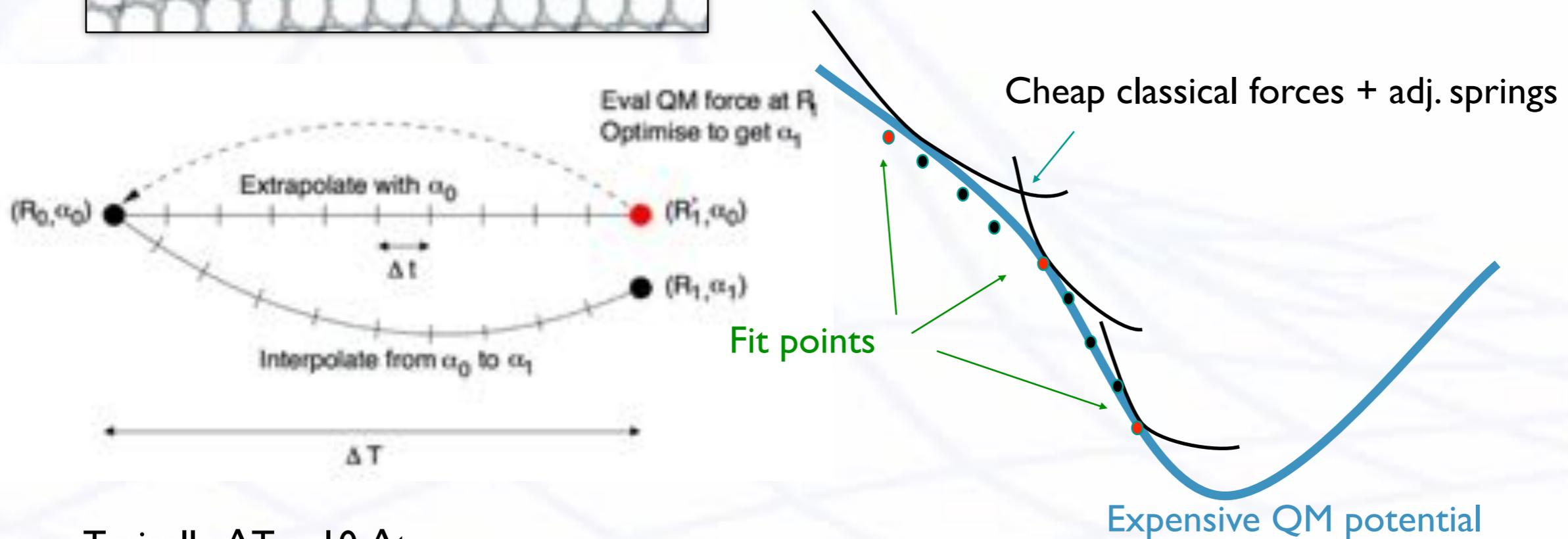
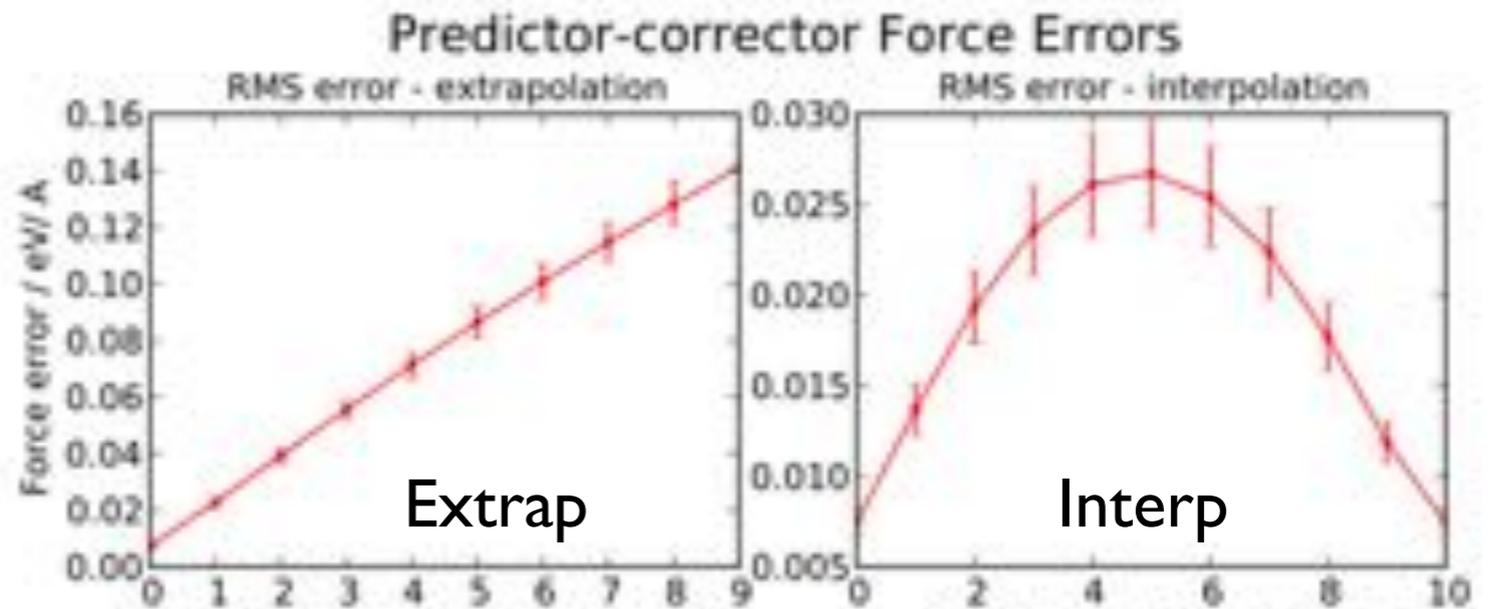
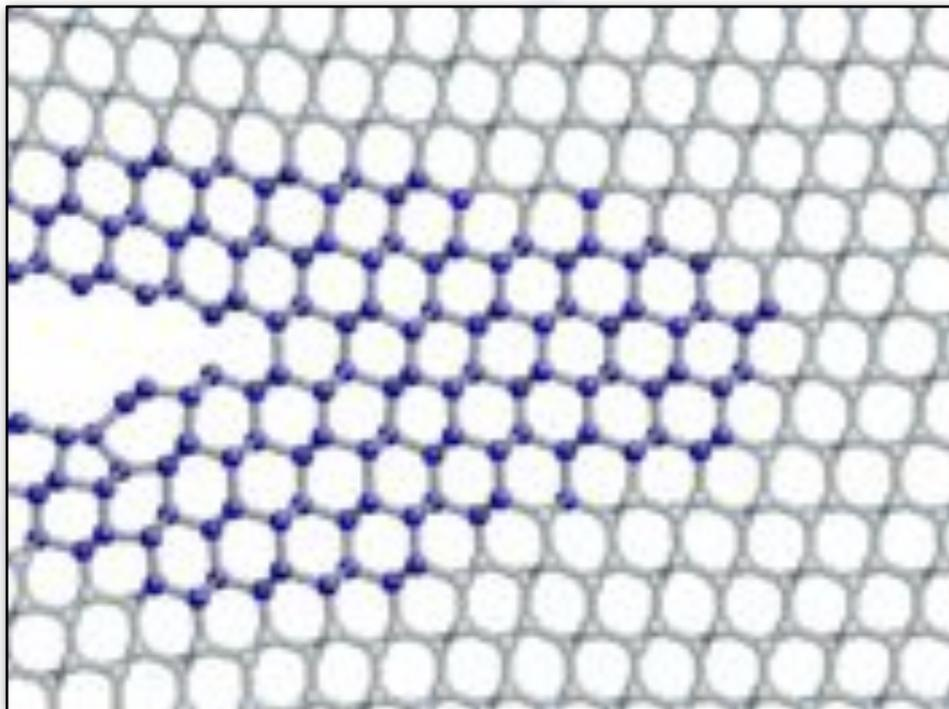

Typically $\Delta T \sim 10 \Delta t$

Towards Optimal Information Efficiency

- Recent trend of automatic, non-parametric force field construction using Machine Learning techniques (e.g. NNs [1], GAPs [2]), extending force-matching approach
- *Our Idea*: rather than learning whole PES once-and-for-all, use same technique, Gaussian Process regression, to predict QM forces as a function of local atomic environment
- Keeping “in touch” with QM reduces risk of extrapolating outside of fit domain

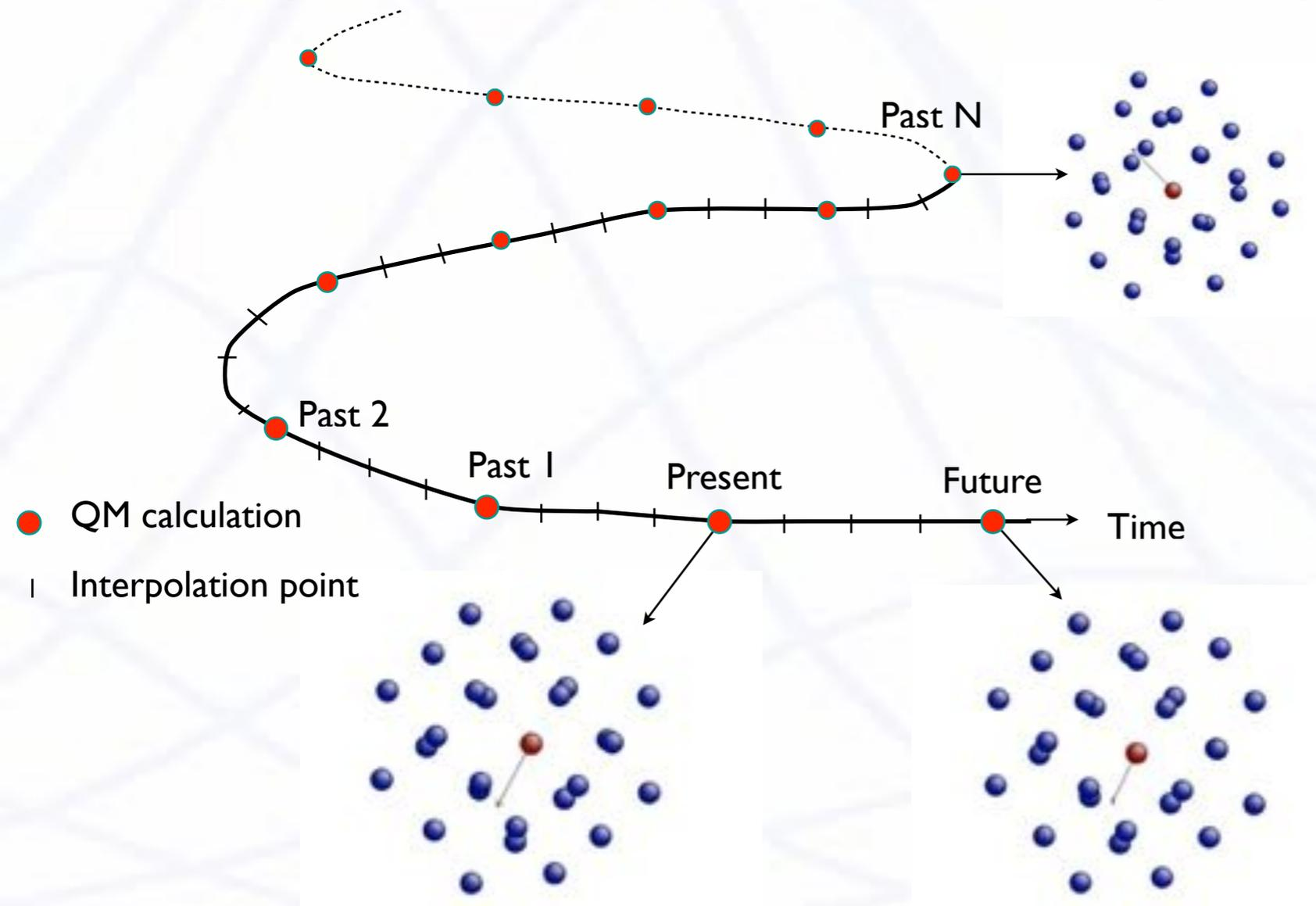

Accelerate QM/MM with ML-based scheme where forces on atoms are:

- *Either* predicted using Gaussian Process regression
- *Or* computed on-the-fly and added to growing ML database

Gaussian Process Regression

Gaussian Process (GP) regression: use Bayesian inference to compute most likely function values given data and a prior distribution for model parameters

ID Example:

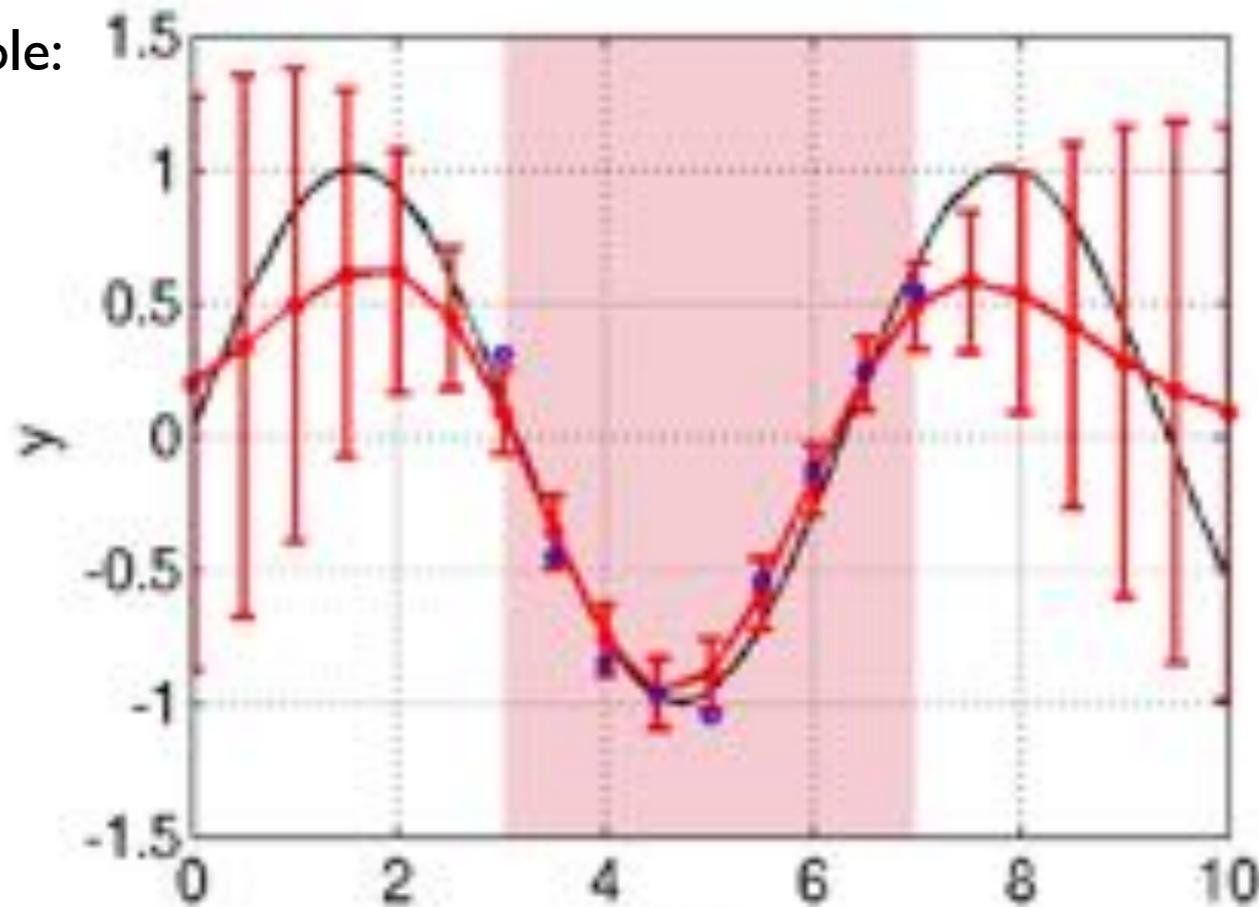

$$\begin{array}{c}
 \text{Posterior} \\
 \hline
 p(\text{parameters}|\text{data}) \propto \\
 \hline
 \underbrace{L(\text{data}|\text{parameters})}_{\text{Likelihood}} \underbrace{p(\text{parameters})}_{\text{Prior}}
 \end{array}$$

Black: function $f(x)$

Blue: observations
 $y_i = f(x_i)$

Red: GP mean, std. dev.

Covariance
(smoothness of prior)

$$C_{mn} = \exp\left(-\frac{d_{mn}^2}{2\sigma_{\text{cov}}^2}\right) + \delta_{mn}\sigma_{\text{err}}^2.$$

Posterior mean

$$y_{N+1} = \mathbf{k}^T \mathbf{C}^{-1} \mathbf{y}$$

Posterior variance

$$\sigma_{y,N+1}^2 = \kappa - \mathbf{k}^T \mathbf{C}^{-1} \mathbf{k}$$

Covariance matrix \mathbf{C}

Feature vector \mathbf{k}

Self-covariance κ

Describing Atomic Environments

Application to force learning: compute *most probable* force given database of atomic environments and associated QM forces (plus a prior assumption that forces vary smoothly as atoms move).

Requires a measure of “similarity for force learning” of two atomic configs, invariant to *translation*, *permutation* and *rotation*. Complication: forces are vectors!

Internal vectors
($i = 1 \dots k$)

$$\mathbf{V}_i = \sum_{q=1}^{N_{\text{neighb}}} \hat{\mathbf{r}}_q \exp \left[- \left(\frac{r_q}{r_{\text{cut}}(i)} \right)^{p(i)} \right]$$

Feature matrix

$$X_{ij} = \mathbf{V}_i \cdot \hat{\mathbf{V}}_j = (V A^T)_{ij}$$

$$V^T = \begin{pmatrix} | & & | \\ \mathbf{V}_1 & \dots & \mathbf{V}_k \\ | & & | \end{pmatrix} \quad A^T = \begin{pmatrix} | & & | \\ \hat{\mathbf{V}}_1 & \dots & \hat{\mathbf{V}}_k \\ | & & | \end{pmatrix}$$

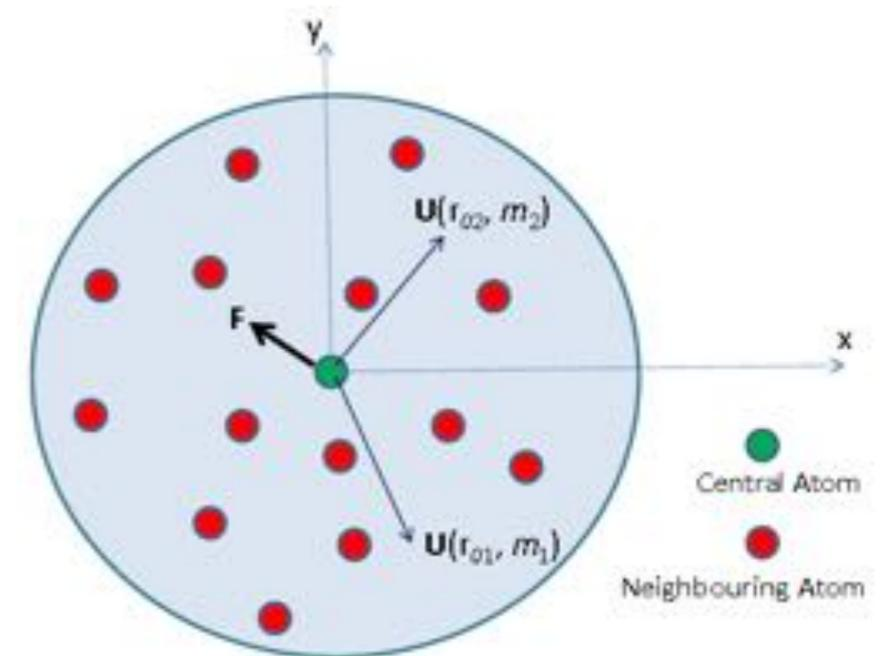

Distance metric

$$d_{mn}^2 = \frac{1}{k} \sum_{i,j=1}^k \left[\frac{X_{ij}^m}{\chi_i} - \frac{X_{ij}^n}{\chi_i} \right]^2$$

Covariance

$$\text{Cov}(m, n) = \exp \left(-\frac{d_{mn}^2}{2\sigma_{\text{COV}}^2} \right) + \delta_{mn}\sigma_{\text{err}}^2$$

Scale factors over database:

$$\chi_i^2 = \sum_{n,m=1}^N \sum_{j=1}^k \frac{(X_{ij}^m - X_{ij}^n)^2}{N^2}$$

“Curse of dimensionality” – QM is long range

- Forces depend mostly on atoms within cutoff ~ 10 Å from central atom
- Project target forces into internal coordinate system (dim. $k \sim 10-20$)
- Perform GP regression there
- Overdetermined system - transform back to find ‘best’ absolute Cartesian reference frame in least squares sense

$$\mathcal{F} = A\mathbf{F}$$

$$A^+ = (A^T A)^{-1} A^T$$

$$\mathbf{F} = A^+ \mathcal{F}$$

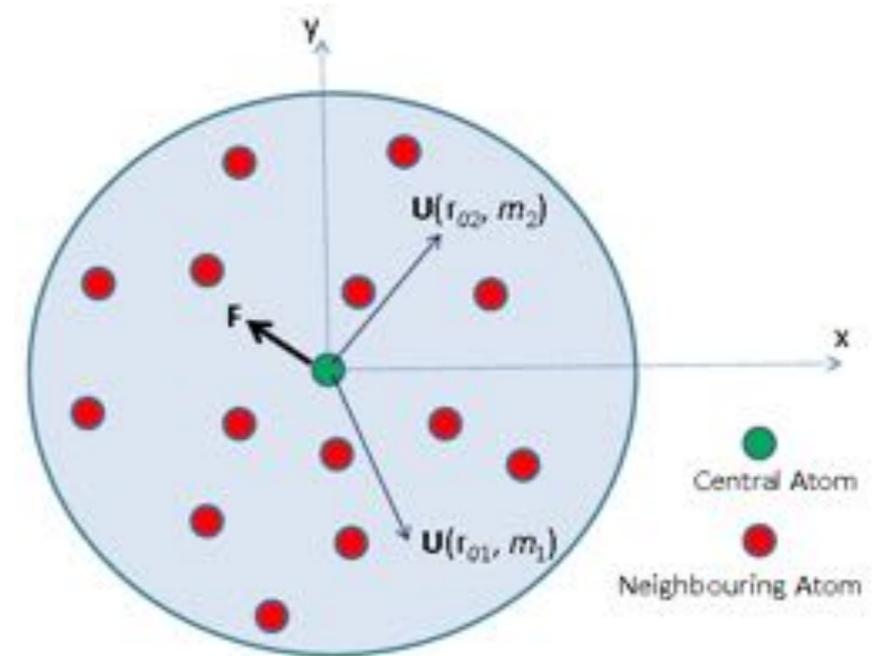

ML for forces – interpolation accuracy

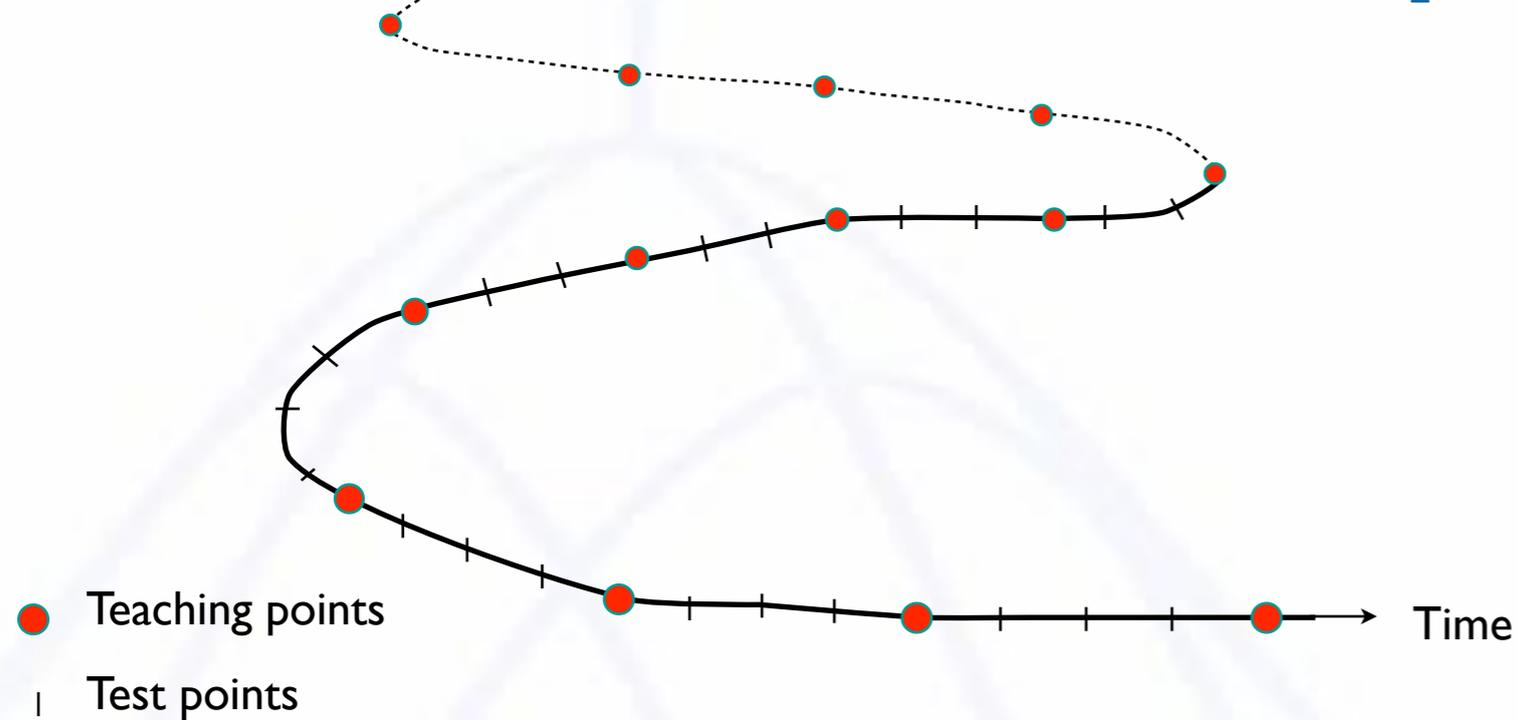

Teaching database built from
~2000 configs at 20 fs intervals
along a reference DFT MD
trajectory in Si at 1000 K

Measure *interpolation* ability: test
configs midway between
teaching points

ML for forces – interpolation accuracy

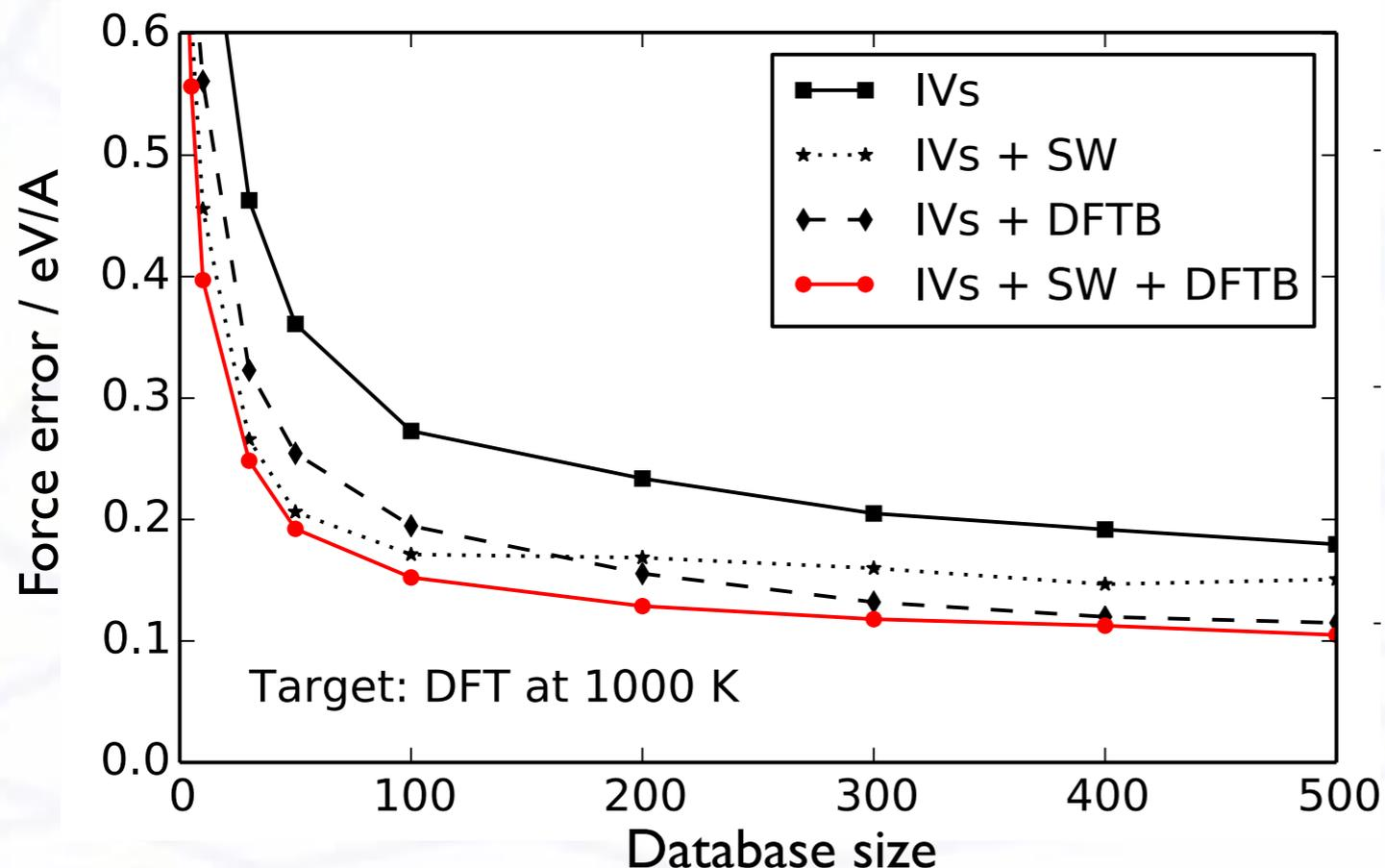
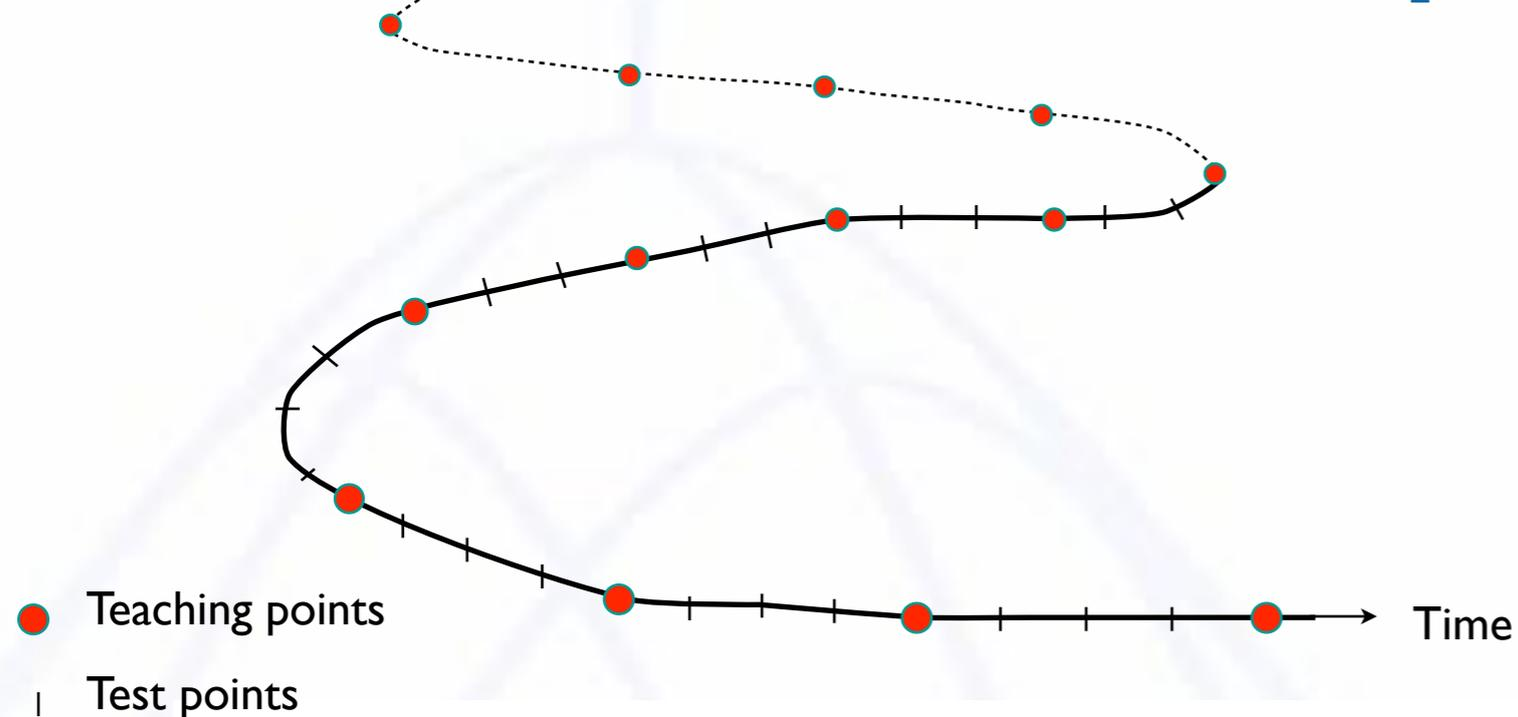

Teaching database built from ~2000 configs at 20 fs intervals along a reference DFT MD trajectory in Si at 1000 K

Measure *interpolation* ability: test configs midway between teaching points

Sorting by distance and selecting only ~500 most relevant environments sufficient to predict accurate forces at test points

Augmenting descriptor IVs with classical potential force vectors significantly improves accuracy

~6% force error wrt DFT

High Accuracy Forces: Phonon Spectrum

Computed using forces learnt from 300 K MD trajectory (DFTB)

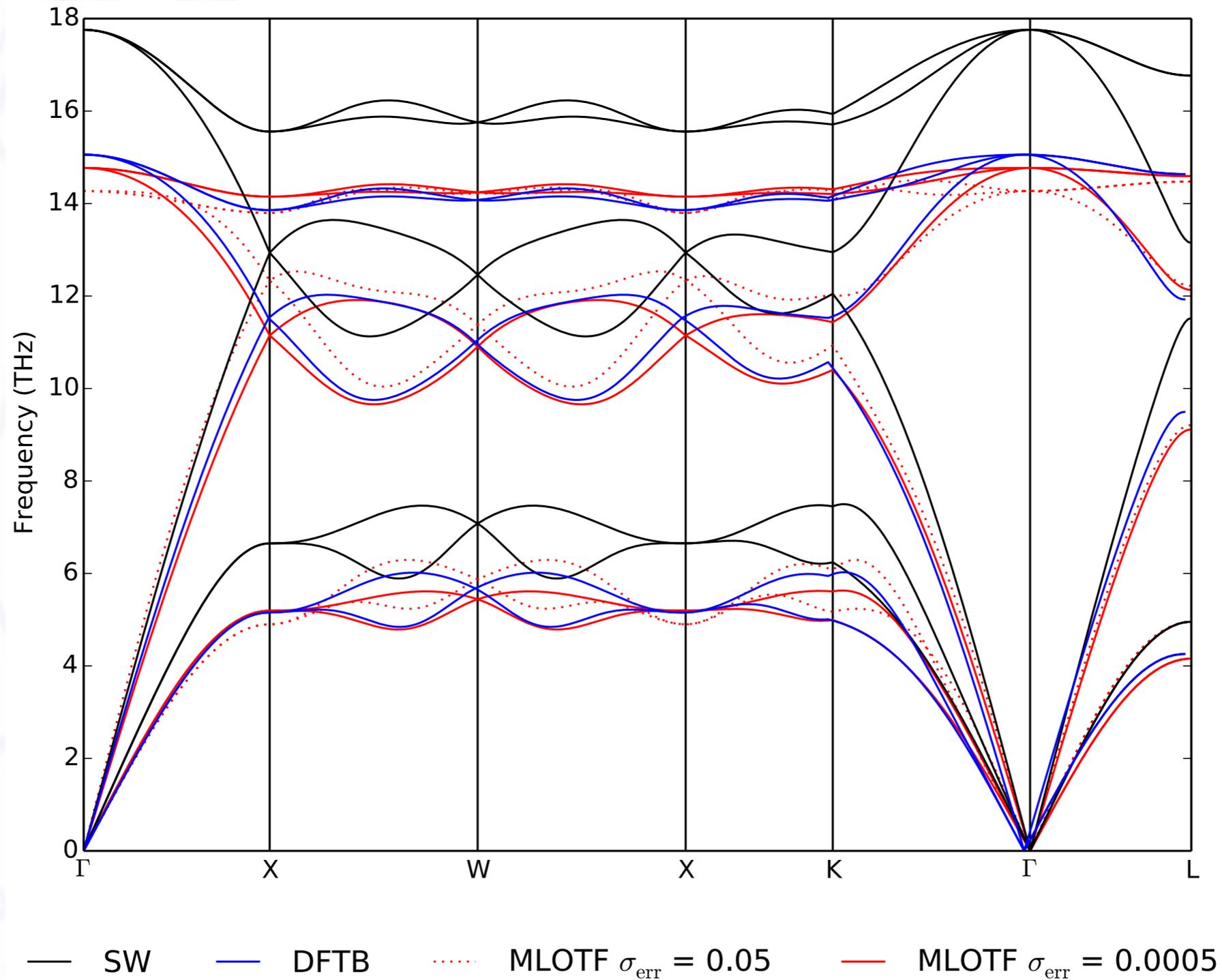

On-the-fly Machine Learning of QM Forces

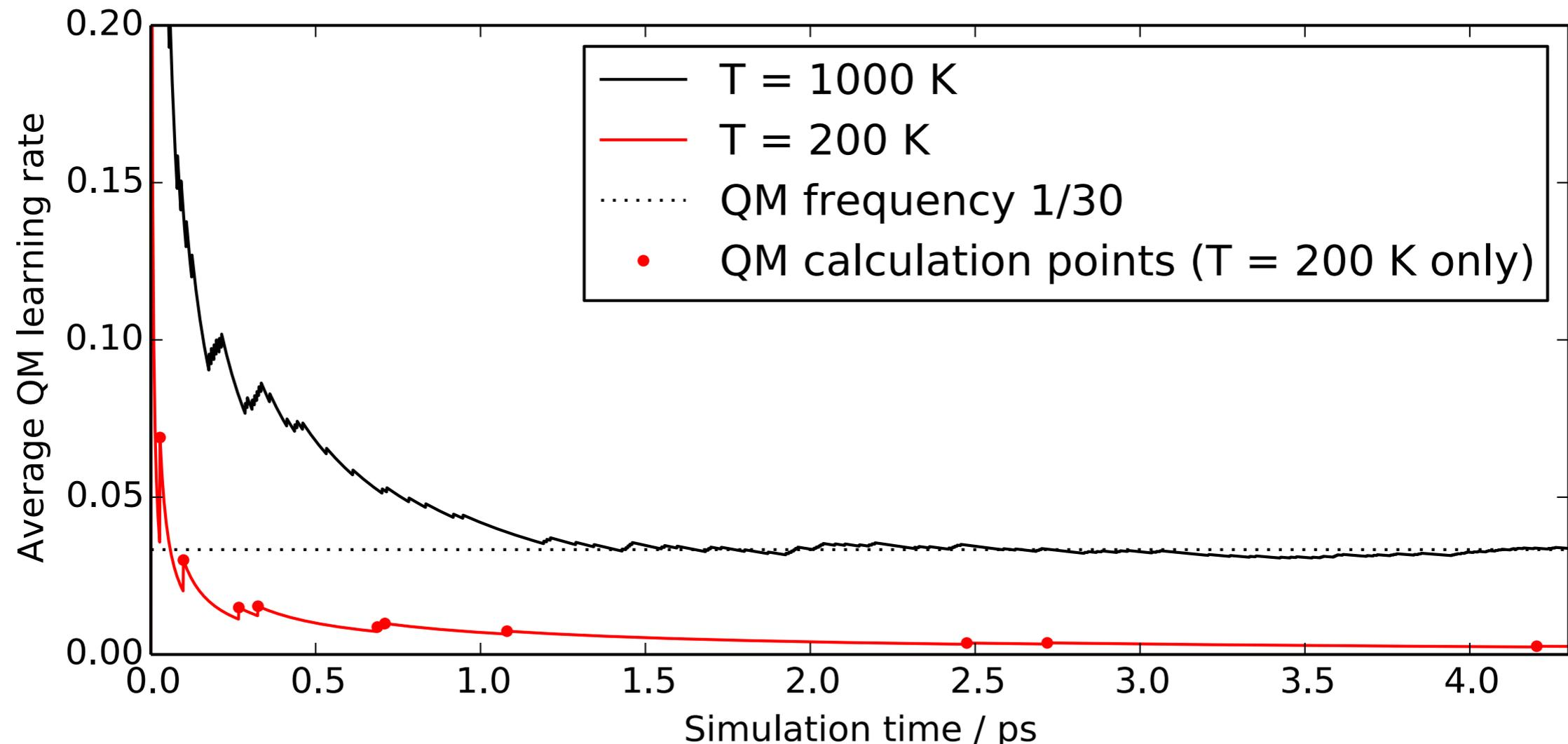

- 64 atom bulk Si test system; QM forces evaluated every step for testing
- Configs added to database when average force error > 0.1 eV/Å
- *Learning rate* provides measure of complexity for MD force learning - ‘chemical novelty’
- $T = 200$ K – long periods (> 1 ps) where no QM is necessary
- $T = 1000$ K – QM calculation rate of 1/30 sufficient after initial phase

Quantifying Chemical Novelty

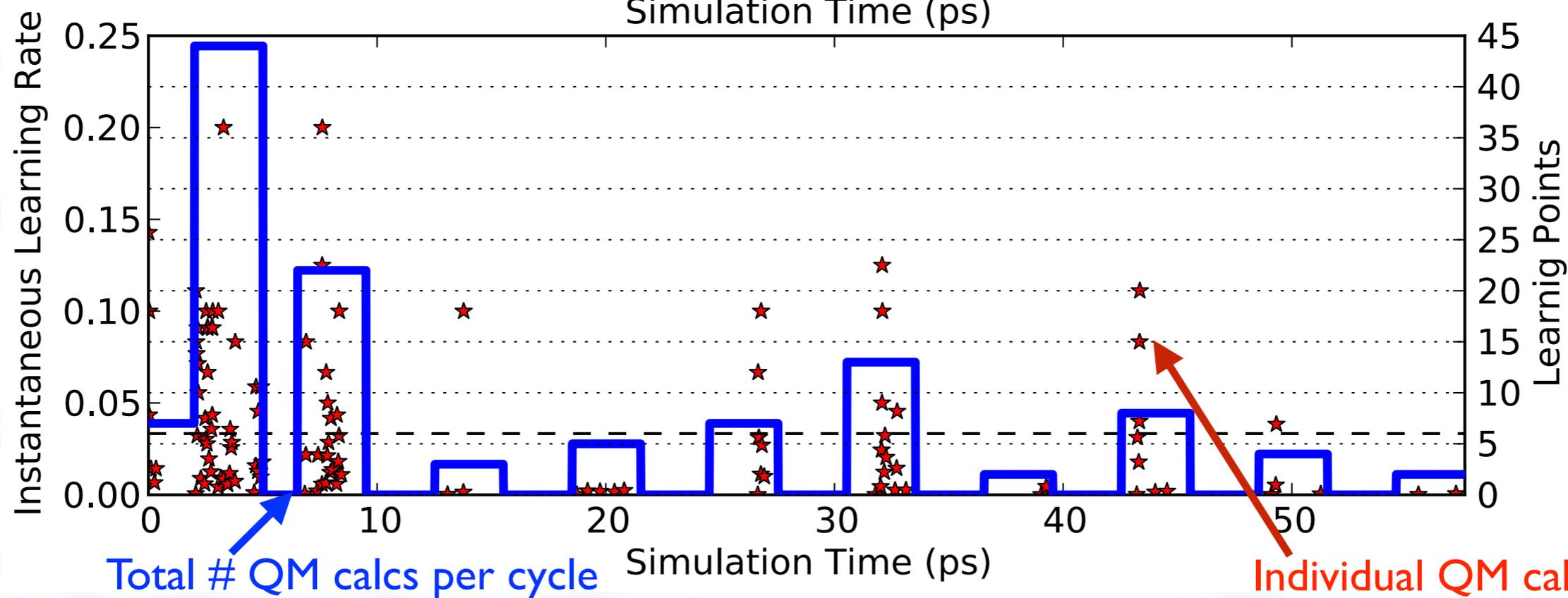
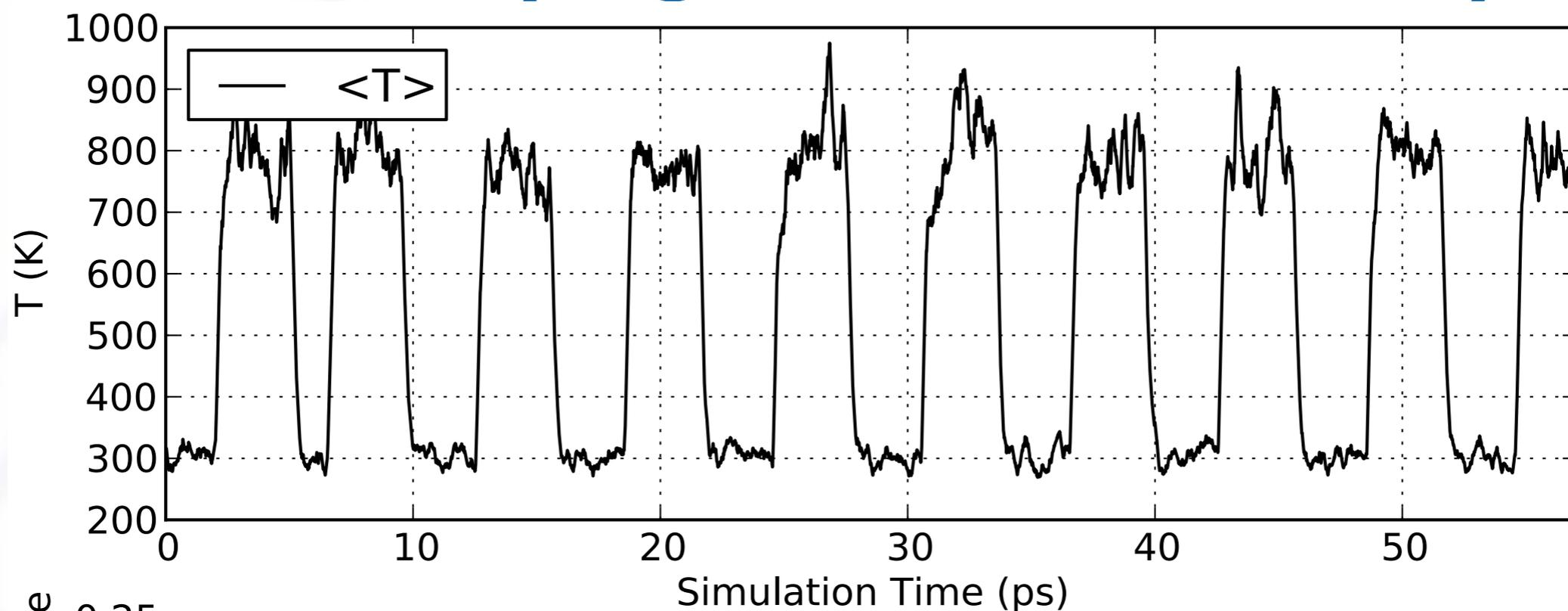

Extension to Multi-species Systems

Internal vectors

$$\mathbf{V}_i^{(s)} = \sum_{q=1}^{N_{\text{neighb}}} \hat{\mathbf{r}}_{sq} \exp \left[- \left(\frac{r_{sq}}{r_{\text{cut}}(i)} \right)^{p(i)} \right] \delta_{Z_s, Z_q}$$

Block feature matrix

$$\mathbf{X} = \left(\begin{array}{c|c} \mathbf{V}_{Z_1} \mathbf{A}_{Z_1}^T & \mathbf{V}_{Z_1} \mathbf{A}_{Z_2}^T \\ \hline \mathbf{V}_{Z_2} \mathbf{A}_{Z_1}^T & \mathbf{V}_{Z_2} \mathbf{A}_{Z_2}^T \end{array} \right)$$

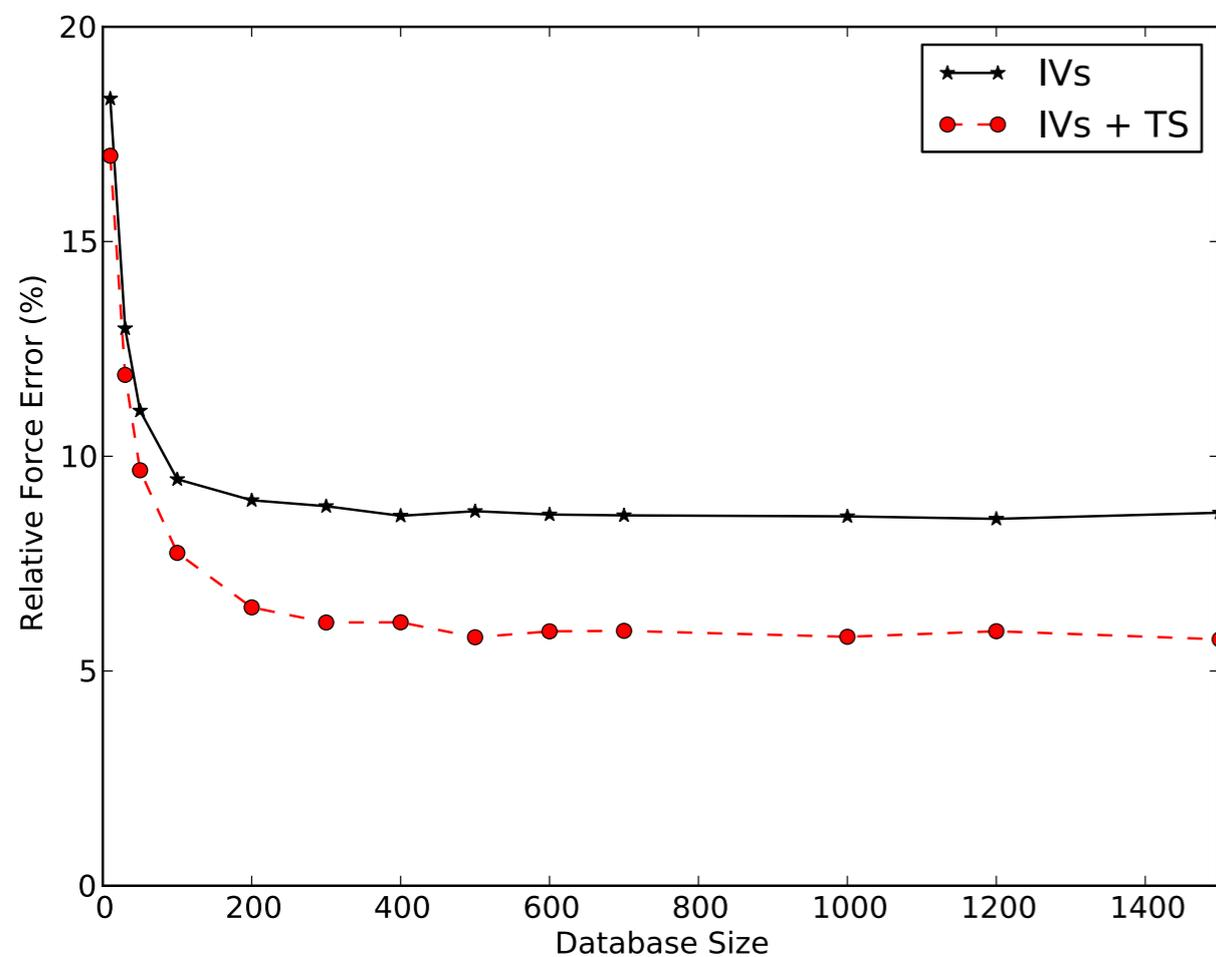

Amorphous SiO₂, target DFT

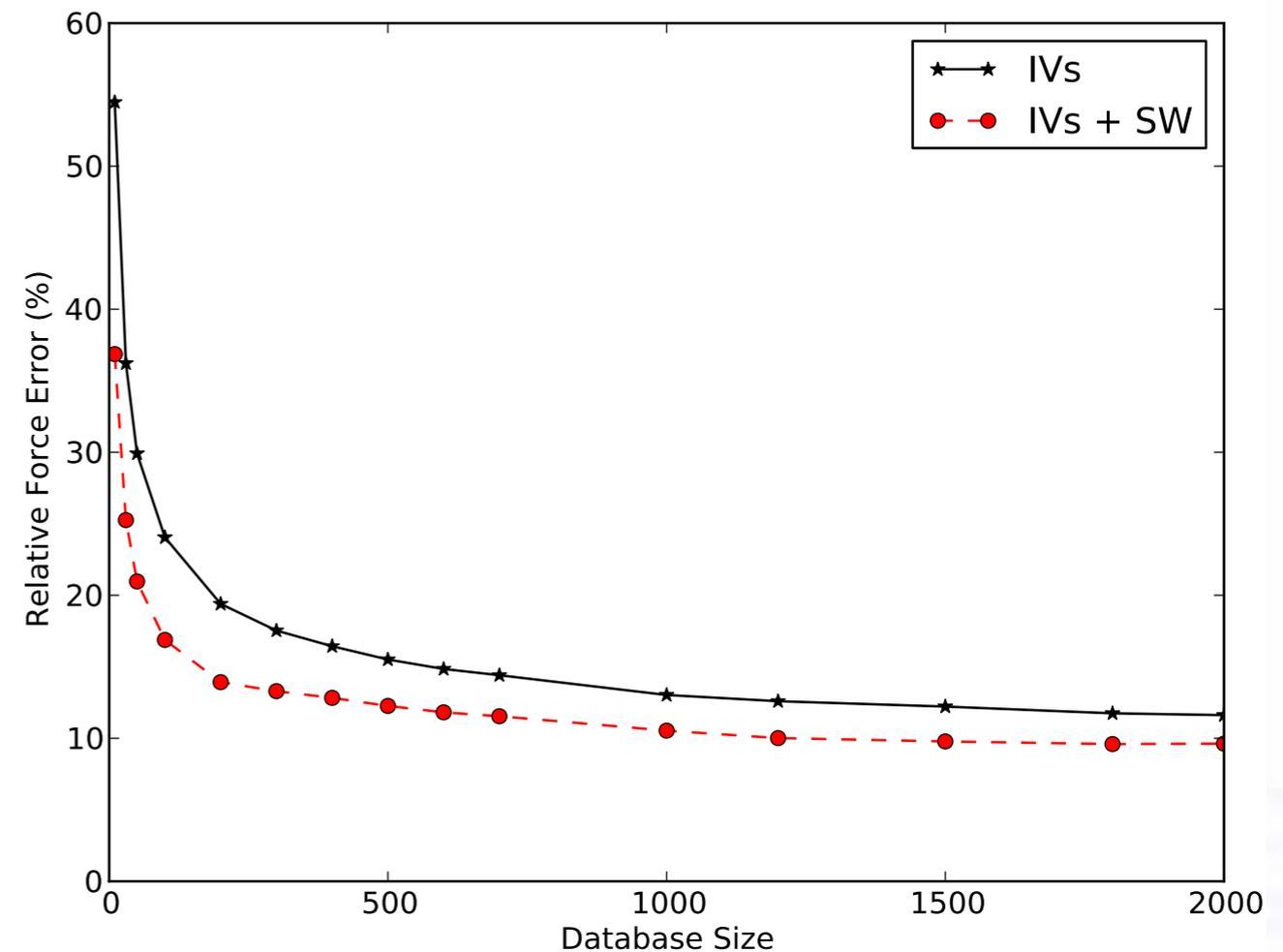

SiC, target DFTB

Summary

- **Hybrid QM/MM approaches allow ‘chemomechanical’ materials failure problems to be modelled with QM precision**
 - Addresses lengthscale limitations of QM approaches e.g. DFT
 - Practical: e.g., experimentally verifiable predictions of fracture phenomena
 - Timescale limitations – prohibitive to model many important processes
- **On-the-fly Machine Learning of QM forces improves timescales accessible**
 - Target optimal information efficiency – only do QM when necessary
 - Need representation of atomic environments suitable for force learning
 - Progressively fewer QM calculations are required when same chemical process is encountered again
 - Chemical ‘novelty’ and uncertainty can be quantified
- **Next Steps**
 - Improved atomic environment descriptors, e.g. vector covariance kernel
 - Use GP variance predictions to quantify uncertainties
 - Integrate on-the-fly ML and hybrid QM/MM approaches
 - Propagation of uncertainties through coarse-graining

Acknowledgments



Federico Bianchini, Marco Caccin,
Zhenwei Li and Alessandro De Vita



Albert Bartok-Partay, Gábor Csányi and Mike Payne



Anke Peguiron, Gianpietro Moras, Lars Pastewka and Peter Gumbsch



Gaurav Singh and Robert Zimmerman



Chiara Gattinoni



Noam Bernstein

Financial support and supercomputing resources:



RioTinto

