

Dimensional Variation Reduction for Automotive Body Assembly

Dariusz Ceglarek and
Jianjun Shi

*S. M. Wu Manufacturing Research
Center, Department of Mechanical
Engineering and Applied
Mechanics, The University
of Michigan, Ann Arbor, MI
48109-2125. e-mail:
darek@engin.umich.edu*

THIS ARTICLE PRESENTS THE METHODOLOGY AND FINDINGS OF A STUDY ON THE ROOT CAUSES OF DIMENSIONAL VARIATION IN AUTOMOTIVE BODY ASSEMBLY. SOLVING DIMENSIONAL FAILURES DURING THE 18-MONTH STUDY LED TO THE REDUCTION OF DIMENSIONAL VARIATION OF THE AUTOMOTIVE BODY FROM AN INITIAL LEVEL OF 8.5 MM TO A BEST-IN-CLASS LEVEL OF 2 MM (6-SIGMA). THE STUDY FINDINGS IMPLY THAT VARIATION REDUCTION ACTIVITIES SHOULD BE ESTABLISHED EARLY IN THE PRODUCT DEVELOPMENT PROCESS SO THAT PROBLEMS CAN BE IDENTIFIED AND CORRECTED DURING PRE-PRODUCTION PHASES.

Shortening launch time, the period from no production to full production, while simultaneously satisfying quality requirements, is a priority of the most advanced automobile manufacturers. Shortening launch time goes parallel with improving quality management, i.e., reducing the opportunity for work to be damaged and shortening the time between defect occurrence and defect detection [1]. Some studies done by Ayres [2] indicate that a surprisingly large fraction of production cost is directly attributable to the prevention of avoidable defects (e.g., quality control), their detection (e.g., inspection), or their elimination after the fact (repair, rework). Informal estimates from various sources suggest that lapses in quality control, i.e., design, inspection, rework, repair, and warranty, may account for 40% or more of total cost [2].

One aspect of vehicle quality is the dimensional integrity of the automotive body (body-in-white), which has great effects on the quality and functionality of the vehicle. In automotive body assembly, geometrical accuracy is one of the most important quality factors. Variation in geometrical accuracy can

stem from both the design and the assembly of an automotive body. In fact, dimensional variation is introduced into virtually every design when the design is manufactured [3]. Because some manufacturing and design induced variation is inevitable, it is important to have a methodology for identifying root causes of dimensional variation, as well as thoroughly understanding the sources of variation during the launch of a new product.

Currently, most common techniques used for improving product quality are based on Statistical Process Control (SPC) techniques. SPC techniques are used during the manufacturing process and are based on the statistical analysis of measurement data. SPC techniques attempt to understand the critical variables in each sequence of a manufacturing process and estimate how these variables interrelate through statistical sampling and experimentation [4]. However, as stated in [4], SPC does not explain the actual causes of defects during the process.

Some sources of assembly defects are given by [5]. One source of assembly defects is interference between mating parts. Assembly defects can also be caused by installing a part in an incorrect position or orientation [5]. Some studies have been conducted to analyze the relationship between assembly process and product defects in assembly of electronics devices [6]. Currently, in automotive industries quite a few studies related to dimensional faults have been conducted [7-16]. Some of them analyze the general engineering and economic aspects of dimensional faults [7, 8]. Others analyze a specific part of the product development cycle, usually during the full production phase [9] or present a general approach for reduction of dimensional variation [10-16]. To the best of our knowledge, no comprehensive study classifying the root causes of the dimensional failures during the whole automotive body development cycle have been conducted. Currently, the knowledge about relations between the dimensional variation of the vehicle and its functional performance, as well as assembly line failures during production are not very clearly understood. This lack of understanding results in wasted effort during design, launch, and production of a new vehicle, because the work does not target the most critical process/product issues.

This paper tries to fill this gap by presenting a

classification of the root causes of the dimensional failures that occurred during the last 18 months of a new product development cycle, which was equivalent to the period needed to reach the design's inherent level of product dimensional variation. The paper provides a better understanding of the area of assembly more prone to dimensional failures, and provides recommendations for further improvement. Additionally, it aims to help the research community focus on the critical aspects of dimensional variation by better utilizing existing analytical methods, or on developing more effective approaches. The results of this paper are based on studies conducted in an automotive assembly facility where sport utility vehicles are manufactured. The analysis of the root causes of dimensional faults occurred during the pre-production phase (pilot program), launch, and full production on one and two shifts. Following this introduction, the paper is divided into three sections. The following section provides background on the automotive assembly process, and illustrates the product development phases. Then, we present our methodology for reducing the dimensional variation of the product. Following the methodology section, we report on a field study, summarizing root causes of dimensional variation and presenting one illustrative case study. In the final section, we discuss the implications of the work and summarize the conducted studies.

AUTOMOTIVE BODY: DESIGN, ASSEMBLY PROCESS, AND PRODUCT DEVELOPMENT PHASES

Assembly of the automotive body, shown in Figure 1, is dominated by geometrical relations, so that the quality of the assembly process can be determined by dimensional integrity of the product. This means that the level of product dimensional variation can be a critical index for final evaluation of the assembled vehicle.

Product and Process

An automotive body is built from sheet metal parts that have different shapes, sizes, and thicknesses, depending on their functions. The parts are categorized as structural or nonstructural. Structural parts support the automotive body structure as (1) main parts, such

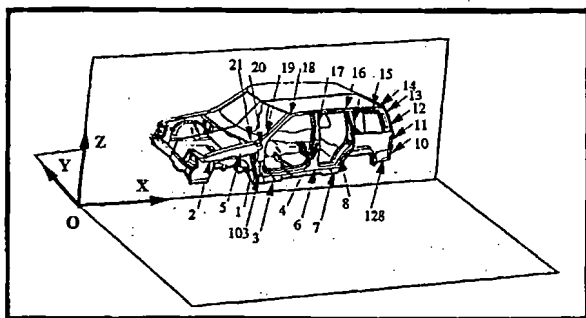

Fig. 1. The body coordinate system with an example of sensor locations.

as rails and plenum, or as (2) reinforcement parts, for example, door hinge reinforcements. The other parts are called nonstructural parts, for example, door outer, cowlside, roof, and so on. Based on the research conducted by [13, 17], it can be concluded that structural parts, mainly due to their greater rigidity, have much greater impact on automotive body dimensional accuracy than nonstructural parts.

The automotive body assembly process includes three major elements: (1) assembly fixtures, (2) welding robots or welding guns, and (3) part handling mechanisms. These three elements conduct the three major functions of the assembly process: part positioning, part joining, and part/subassembly transfer.

On a typical plant floor, these elements are linked into assembly lines dominated by part positioning and welding stations. Each assembly line produces a major subassembly or final product. There are usually two types of lines: (1) component subassembly lines, and (2) framing assembly lines. The component subassembly lines are: underbody line, and two aperture lines—left- and right-hand. The major element of the framing line is an automotive body framing station, where underbody, apertures, and roof bows are jointed together. Figure 2 shows an outline of an assembly line with descriptions of the geometrical stations in the framing line. The framing station is marked as S_3 . In general, all stations can be divided into geometrical and re-spot stations. The geometrical stations handle parts with position-setting mechanical jigs designed for each type of vehicle. The part is set in position by these dedicated jigs, initially welded, then transferred to a re-spot station for final welding. During the re-spot operations,

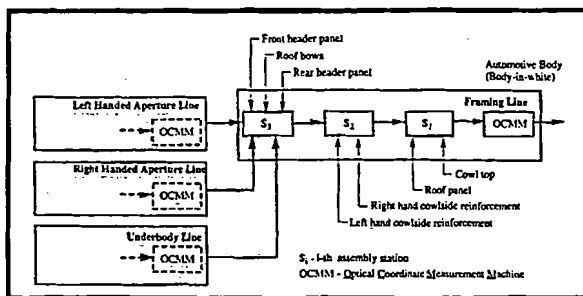

Fig. 2. Outline of the assembly process: critical stations of the framing line.

robots add welding spots to the parts to increase their strength. Re-spot stations usually do not affect the position or orientation of the part or subassembly. Based on the research done by [13], the geometrical stations have a much bigger impact on the dimensional variation of the product than re-spot stations.

The total number of geometrical stations varies from process to process. On average, at least 25–35 geometrical stations and no less than 30–40 re-spot stations assemble an automotive body made of 150–250 sheet metal parts.

The major function of the assembly station is to correctly position parts before welding operations start. The usual method of positioning stamped parts is based on the 3-2-1 layout principle [7]. However, during studies of actual assembly processes, it was also noted that an n -2-1 layout principle, where $n > 3$, is often used. The selection of the part locating principle depends on the size and rigidity of the part [18–19], and directly affects the inherent level of product dimensional variation.

Part transport to and from stations is accomplished by many different mechanisms, such as electrified monorails, tip-up drives, and so on. Detailed descriptions of other automotive body assembly processes can be found in [12].

Measurement

Modern dimensional diagnosis of the automotive body requires accurate data to satisfy quality assurance requirements. Currently, three measurement gages are most often used for checking part/subassembly dimensions: (1) hard gage fixtures and layout plates [8, 20], (2) Coordinate Measuring Machines (CMMs), and (3)

Optical Coordinate Measuring Machines (OCMMs). The presented study mainly used data from CMM and OCMM gages.

Coordinate Measuring Machines

Introduced during the 1960s, CMMs are very accurate and flexible. They allow for measurements at selected points on the part with an accuracy of 0.01 mm. Their flexibility is based on their capacity for quick reprogramming measurement cycles when checking different parts or points. The drawback of CMMs is the time lag before receiving measurement information. An automotive body must be taken off-line and transferred to the CMM room for measurement. A fully operational CMM can measure up to eight automotive bodies during eight hours. The results from the CMM are useful for assessing the final quality of an automotive body or subassemblies.

Optical Coordinate Measuring Machines

In recent years, the implementation of the in-line Optical Coordinate Measuring Machine (OCMM) in the automotive industry has provided new opportunities for automotive body assembly diagnosis. OCMMs are installed in-line at the end of major assembly processes, such as framing, side frames, underbody, and so on. (Fig. 2). Each OCMM consists of many laser sensors allowing for noncontact measurement of a body or sub-assembly relative to design nominal. On average, the measurement cycle takes a few seconds, with accuracy around 0.25 mm, and static and dynamic repeatability within $6\text{-}\sigma$ equal to 0.14 and 0.25 mm, respectively [21]. The OCMM gage measures from 100 to 150 points on each major assembly with 100% sample rate. As a result, the OCMM provides a tremendous amount of dimensional information, which can be used for assembly process control. All OCMMs in the plant use the same coordinate system, called the body coordinate system, because it is easy to use and compares data from different gages. Fig. 1 shows the coordinate axes and reference points in the body coordinate system. The principles of the measurement sensors are described by [22], and the outline of the sensor setup for automotive body assembly can be found in [10].

Product Development Phases

One of the characteristic features of the automotive industry is the frequency of model changes and the vast amount of time and labor required to make a changeover. The automotive body assembly is regarded as the least flexible process in the overall vehicle assembly process [23]. During a model change, tooling must be changed to match the newly established process and product design. Given the complexity of this process, the automotive body development cycle requires three to four years of lead time. Even the final stage of the automotive body development cycle, after vehicle and hard tooling are designed, lasts one year. This final stage includes the following phases: (1) pilot program, (2) pre-volume production, (3) launch, and (4) full production. These phases are described in the following paragraphs, focusing on the dimensional issues.

Pilot Program

The pilot program is when prototype vehicles are built to verify manufacturing processes after 100% of the vehicle dimensions and tolerances are approved. The pilot program is the first phase, beginning on average five months ahead of the launch. It includes: (1) verifying the designed PLP (Principal Locating Points) schemes for tooling fixtures during the assembly process, and (2) setting the process capability of the designed tooling.

Pre-Volume Production

Pre-volume production starts one to two months ahead of launch, after the tooling is set up at the assembly plant. The goal of pre-volume production is to validate process capability, and initially identify the sources of variation.

Launch

After determining that the vehicle can reach acceptable quality levels, the launch phase follows. Typically, at launch phase, a number of problems must still be resolved before a vehicle of desired quality level can be built. The length of the launch phase depends on how fast all dimensional problems can be resolved while simultaneously speeding up the production rate. Identification of dimensional faults becomes one of the bottlenecks in reaching the full production rate.

Full Production

The full production phase begins, after the production rate reaches the assigned level with acceptable quality. Typically, at this phase, assembly line maintenance issues and product quality assurance requirements become dominant.

VARIABILITY CONTROL OF PRODUCT GEOMETRY DURING ASSEMBLY PROCESS—METHODOLOGY

The dimensional quality of a product is directly related to the variability of the process that created it. Dimensional variation can be used as an index to evaluate the dimensional quality of a product. But analysis of process variability, especially in industrial practice and research, can be a very complex problem. In production, a measured variation of product consists of a set of smaller variations caused by many different factors called root causes. Once the particular variation of a product is determined by measurement data, it is important to analyze it and break it down to the individual root causes that may have occurred during the process. The procedure of determining an individual root cause of dimensional variation is presented in this paper as a case study.

The methodology applied during the study can be divided into two parts. The first part is used to evaluate or "track" the level of dimensional variation using a defined variation indicator. The second part describes the case study procedure used to identify and localize root causes of dimensional variation based on the measurement data. Both parts are described in the following sections.

Tracking the Dimensional Variation Level

The tracking of dimensional variation, used as a quality index, needs to show the level of variation and the time of occurrence. It is important to track variation level through different phases to know not only the current quality level of the product, or achieved improvement in time, but also to use it as a benchmarking index allowing for comparison of different products or their development cycles.

The dimensional variation level is assessed based on the measured points on the product. Fig. 1 shows an example of measurement point locations on one side of

the automotive body. These points are chosen for measurements because they are the most critical points on the body, called KPC (Key Product Characteristics), or KCC (Key Control Characteristics).

The KPC is a product characteristic for which dimensional variation could significantly affect a product's safety or compliance, as well as customer satisfaction with a product. The KCC is a process parameter for which the variation must be controlled to ensure that variation in a KPC is maintained during the assembly process. For example, measurement points 4, 17, 18, and 19, which define the front door opening, are recognized as KPCs. They control the door-fitting process in the final vehicle. The measurements of PLP locators are usually recognized as KCCs.

The KPC and KCC are selected during the pilot program to describe the dimensional characteristics of the product and process, respectively. A parameter describing dimensional variation of the automotive body is defined as 6-sigma standard deviation calculated for each measurement point with a given sample size. The 6-sigma for each measurement point can be presented in the form of a percentile chart (Figure 3), showing the distribution of the dimensional variation throughout the measurement sensors. The final indicator of product variation level can be presented as a Continuous Improvement Indicator (CII). The CII is selected as an upper limit of 95% of all 6-sigmas calculated for all measurement points of the product. For example, in Fig. 3, the CII indicator shows variation within 4.5 mm (6-sigma) for 95% of measurement points.

The CII can be used for fast tracking of product

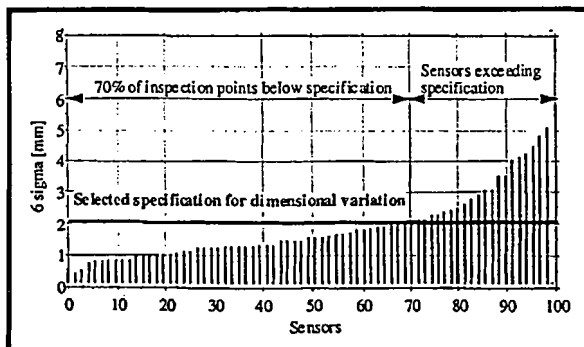

Fig. 3. Example of percentile chart for dimensional variation evaluation.

variation level. The presented studies used the CII indicator shown in the form of a chart with the horizontal and vertical axes representing the consecutive weeks of production and 6-sigma variation for 95% of measurement points respectively (see upper part of Figure 4).

Case Study Approach to Diagnose Root Causes of Dimensional Variation

The study of dimensional faults requires the use of a methodology that will allow for the identification and localization of root causes of dimensional variation.

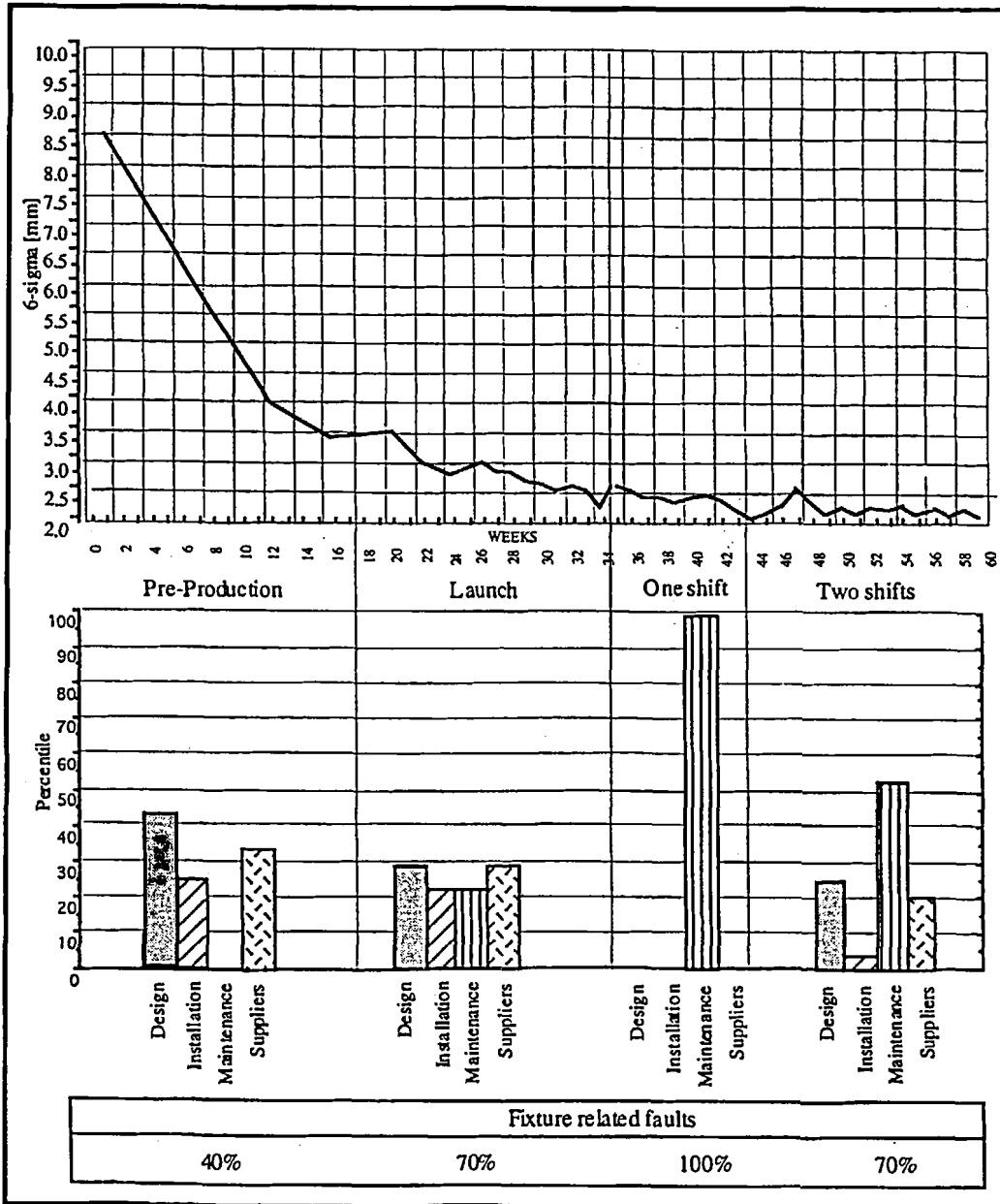

Fig. 4. Root causes classification based on the four production phases.

A newly developed diagnostic methodology was presented in [13-16]. The methodology is based on a systematic, data-driven case study approach that enables quick detection and localization of assembly process faults based on dimensional measurements. The case studies group and prioritize the current variation level into traceable and solvable problems in order to reach the intended variation level. Therefore, a case study describes a body-in-white dimensional failure characterized by a particular variation pattern and caused by one (or several) root cause(s).

Examples of dimensional variation root causes are: assembly fixture-related (NC locator wear, inclusions on the locating surface of locators, or clamps that do not properly force the part against the locator), welding gun-related (missing welding spot, misaligned welding gun, welding tip wear), stamped part-related (inconsistent press tonnage, press stroke), and material handling-related (interferences between part handling locators and fixture locators).

The problem-solving methodology includes knowledge representation of product and assembly pro-

cess, and fault root cause identification and localization approaches.

Knowledge Representation of Product and Process

The complexity of the automotive body prevents measurement data from being sufficient to localize root causes of dimensional variation. It is necessary to include knowledge about the product and the assembly process before the root causes can be determined. Our knowledge representation is based on the functional characteristics of the product, tooling, process, and measurements, which are in turn defined as collections of hierarchical groups [14-15]. The hierarchical groups show the explicit relationship between the most important features of the automotive body assembly, such as: (1) product relations (part-to-part and part-to-subassembly; locators positions of parts/subassemblies), (2) process relations (process layout; parts/subassemblies sequence; welding spot locations and sequence), and (3) measurement relations (location of inspected points and type of measured feature; allocation of each measured point to part/subassembly). Figure 5 shows

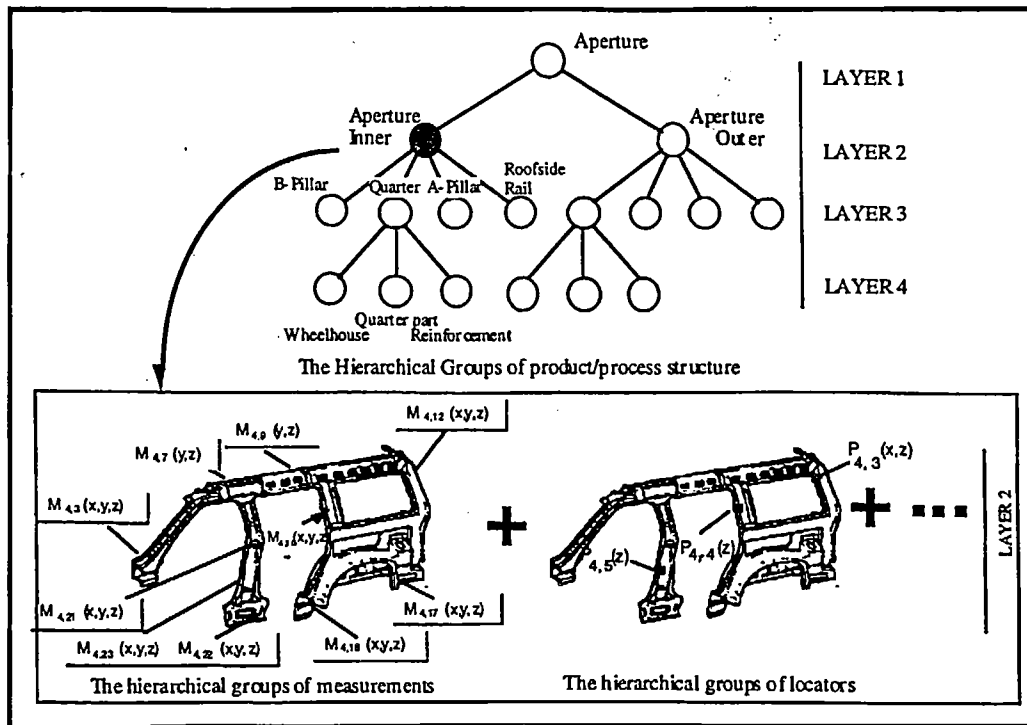

Fig. 5. The knowledge representation of the automotive body assembly.

an example of the hierarchical groups that include knowledge about product/process, measurements, and locators. A major advantage of this knowledge representation is that a great deal of knowledge can be represented within a unified framework, which simplifies access to and speeds the diagnostic reasoning to find root causes of faults. This representation is used during fault localization.

Fault Identification

As shown in Figure 6, fault identification is equivalent to the identification of sources of dimensional variation in the body-in-white by grouping measurements using variation level and correlation coefficient. The procedure of fault identification for sustained dimensional variation selects and classifies the information pertaining to measurements captured during a given period of production time and are based on two criteria:

1. Fault severity criterion—selection of measurement points with variation exceeding variation threshold T_v (Fig. 3). This criterion ensures that the fault identification process will select the measurement points that describe the most severe dimensional faults. Variation threshold T_v was set so that 30% of all measurements were included for further analysis.
2. Fault root cause isolation criterion—selection of measurement points with correlation exceeding correlation threshold T_c . This criterion selects measurement points describing faults with a single root cause. It is based on the assumption that the measurements with large variation will be strongly correlated if and only if their variations are caused by the same root cause. For example, if measurement data include variation caused by fixture locator failure, the pattern described by the data will follow the pre-determined pattern of the faulted locator. Therefore, based on the characteristics of body structure and tooling locators, some points will “move” together during the assembly process. In a statistical sense, “moving” together can be interpreted by correlation between the measurement points. Each group of

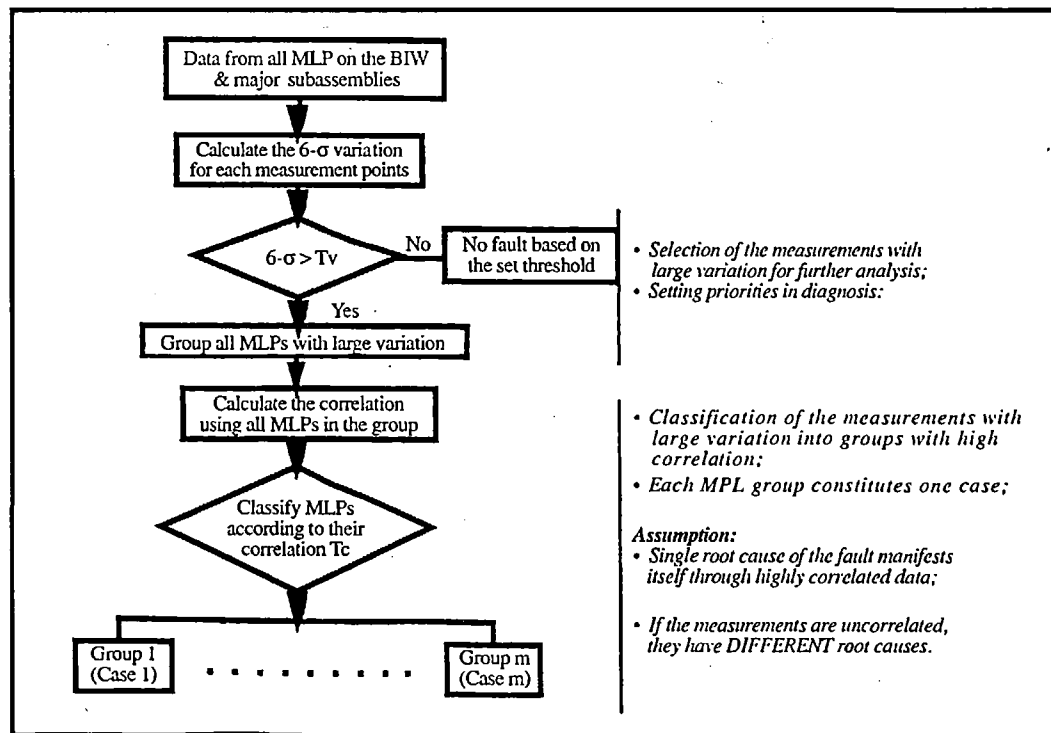

Fig. 6. The flow chart of diagnostic reasoning: fault detection.

correlated measurement points called candidate measurement points (CMLP) represents a case study.

Fault Localization

The fault localization procedure localizes the failing part, as well as the assembly station causing that failure based on the selected CMLPs (Figure 7) [13-14]. The fault is localized by identifying the position of CMLPs on the component subassemblies of the body-in-white using hierarchical groups of product/process. The component with the biggest number of CMLPs represents the most likely failed component and is called the candidate component. Additionally, the hierarchical groups of the product/process show the assembly station where the candidate component is assembled. This station most likely causes the fault and is called the candidate station.

FIELD STUDY: SPORT UTILITY VEHICLE

To determine the root causes of dimensional faults and to determine how these faults would affect the dimensional quality, an analysis of solved case studies is conducted. The objective of this analysis is to summarize the knowledge and experiences gained from variation reduction activities. It focuses primarily on drawing a guideline for future implementation during design as well as during launch of a new product. The following section presents an example of one case study with dif-

ferent types of root causes. Following that section, the analysis of all case studies is presented.

Example of Case Study: Cowlside Reinforcement Cyclic Variation

This case study illustrates a dimensional fault pertaining to tooling installation, which was detected by an OCM measurement gage in the framing line. The fault occurred during launch phase. This fault has direct influence on the quality of the fender alignment. Correcting this fault involved reprogramming the original program of a welding robot.

Fault Identification

Measurement points 2L and 5L on the body-in-white showed large 6-sigma variation in the Y axis (Inboard/Outboard) equal to 2.91 and 3.16 mm, respectively. Both measurement points showed strong correlation (0.94). Figure 8 shows the location of the cowlside reinforcement panel and sensors 2L and 5L in the body-in-white. The other measurement points did not show strong correlation with points 2L and 5L.

Fault Localization

Because both selected measurement points 2L and 5L were located on the cowlside reinforcement panel, the geometrical station assembling this panel was suggested as a candidate station. The root cause of the

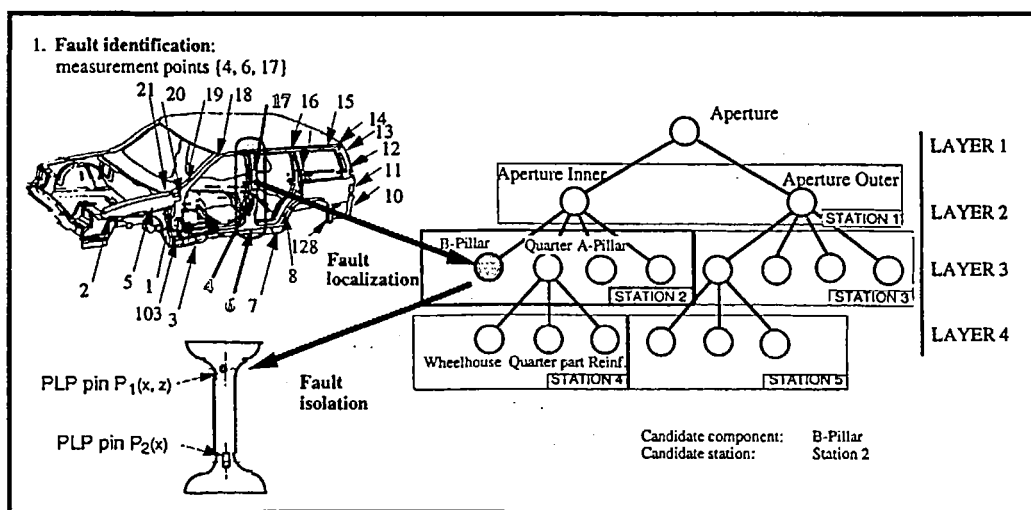

Fig. 7. The fault identification, localization, and isolation procedure.

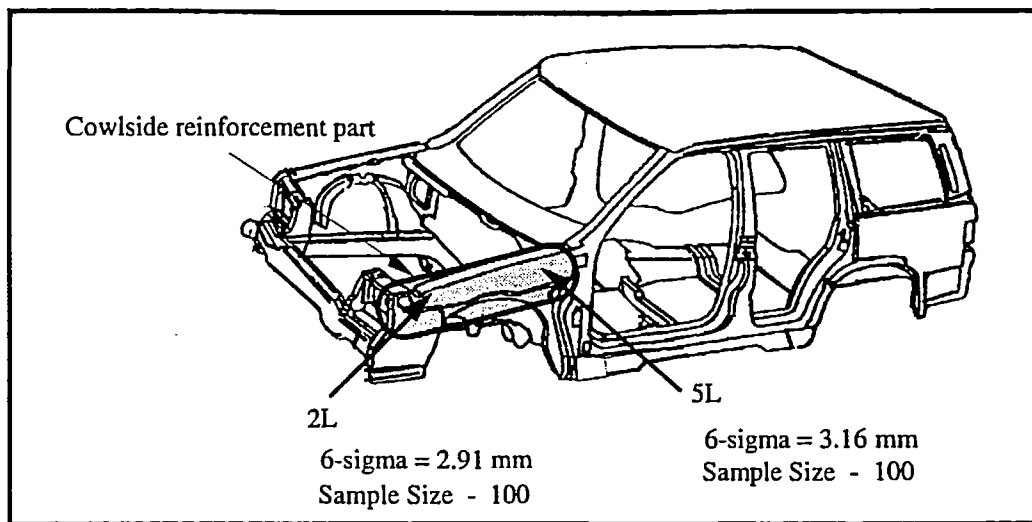

Fig. 8. Body-in-white with marked Cowlside panel and measurement sensors 2L & 5L.

fault was identified by using an X-bar chart and a detailed study of the assembly process in the candidate station. The X-bar charts of points 2L and 5L in Y axis show regular spikes occurring every 26 measurements (Figure 9). Detailed analysis revealed that in the framing line, one welding robot missed two welding spots located on the cowlside panel (Figure 10) every 26 panels after a regular tip dressing operation.

Corrective Action

The problem was caused by the programming of the robot sequence, which was corrected.

Evaluation

After corrective action was completed, variation was reduced from 2.91 to 1.87 mm and from 3.16 to 2.01 mm in the Y axis for sensors 2L and 5L, respectively.

Case Studies Classification Based on Production Phases and Dimensional Variation

The presented analysis examines 52 case studies according to the nature of the problems and classifies them using four different criteria: (1) the root cause of the problem, i.e., design, installation, maintenance, or material variation; (2) the production phase in which the root cause occurred, i.e., pre-launch, launch, or full volume production; (3) the areas or stages in body assembly processes, i.e., subassembly, body framing, and

so on; and (4) the information sources used to detect these problems.

Root Causes of the Dimensional Variation

Fifty-two cases were identified and solved at the assembly facility to reach the best-in-class level of dimensional variation, which is equal to 2 mm (6-sigma standard deviation). Among these case studies, 118 root causes were found. All found root causes can be divided into four major categories: product and process design, tooling installation, tooling maintenance, and supplied material variation. Figure 11 shows the distribution of root causes among these four categories. According to this classification, the contributions to the variation were: maintenance procedures (37%), product and process design discrepancies (27%), supplied panel inaccuracies (23%), and tooling installation mistakes (13%). This analysis indicates that most dimensional variation problems of the body-in-white are caused by incorrect maintenance procedures and design discrepancies rather than supplied panel inaccuracies and tooling installation discrepancies. However, this classification does not analyze the severity of the occurred problems. Based on experience, the most severe and time consuming problems are either supplier-related or design-related problems. In the assembly plant, the average reaction time for maintenance related problems was a few hours (<8 hours). However, correcting design

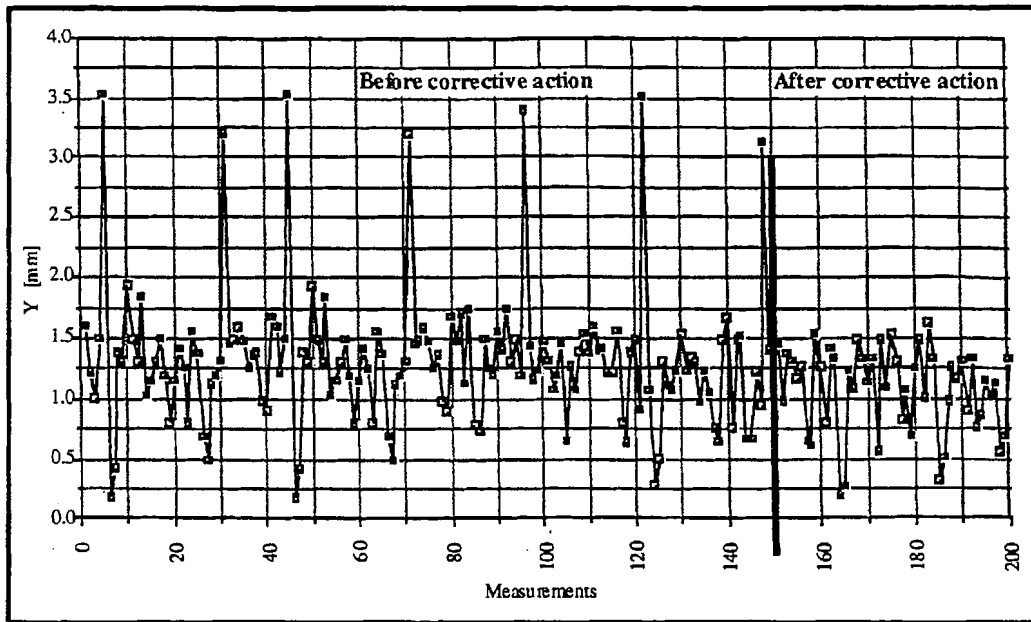

Fig. 9. X-bar chart for measurement data of the sensor 5L.

problems or panels discrepancies took on average of from 1 to 4 months.

Production Phases during which the Root Cause of the Dimensional Variation Occurred

In similar ways, the dimensional faults were classified as a function of time. This classification provides valuable insight into the strengths and weaknesses of the product and assembly process versus the time of their detection.

Figure 4 shows identified fault root causes in each

production phase. The vertical axis indicates the 6-sigma variation of the automotive body, based on the weekly average of daily batches of 100 bodies with 100 measurements taken for each automotive body. The data were captured during a 60-week period. The dimensional problems for each production phase are discussed with particular emphasis on those that affect variation level.

1. Pre-production phase. The 6-sigma variation of the body-in-white was reduced from 8.5 to 3.5 mm during this phase. Tooling design and tooling installation as well as variation of supplied

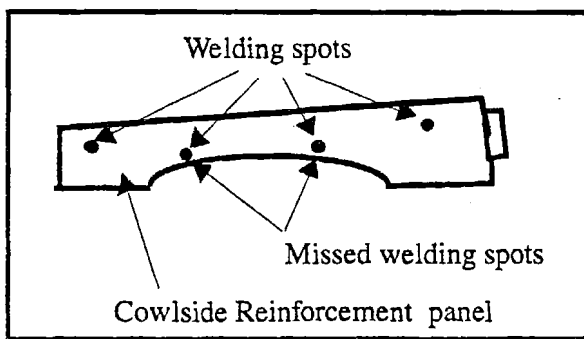

Fig. 10. Case 3 fault mechanism: missed welding spots after welding tip dressing operation.

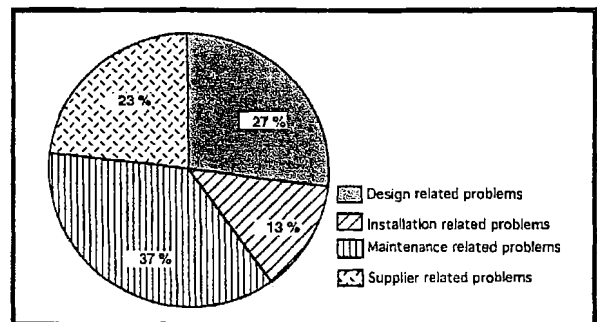

Fig. 11. Classification based on the dimensional fault root causes.

stamping parts were the major root causes of variation. Fig. 4 shows that 42% of the faults at this stage were tooling design-related, 24% of the faults came from tooling installation, and 34% of root causes came from stamping parts. Around 40% of all faults were related to the failure of assembly fixtures. Due to the low volume of production, tooling maintenance was not a major issue during pre-production.

2. **Production launch.** In the launch phase, variation was reduced from 3.5 to 2.5 mm. Similar to the first phase, design and tooling installation related faults were still the major root causes of variation, contributing about 50% of the total number of root causes. Root causes due to the supplied stamping panels decreased to 29%. However, variation caused by tooling maintenance-related faults became important as the production volume increased. In general, the faults related to assembly fixtures rapidly increased to 70% of the total number of faults.
3. **First shift full production.** During the first full production shift, the variation was further reduced from 2.5 to 2.2 mm. Maintenance related problems were the major root causes in this phase. Referring to Fig. 4, it can be seen that almost all root causes were due to maintenance issues. To summarize, tooling design and installation discrepancies had been identified and solved during the pre-production and launch phases and, after increasing the production volume, tooling maintenance procedures became more demanding and critical for dimensional variation.
4. **Second shift launch and full production.** The variation level slightly increased to 2.5 mm at the beginning of the period due to launching of the second shift. After solving several case studies, the variation finally achieved 2-mm level in the fifth month of full production on two shifts. During this period, maintenance-related problems were a major root cause, although they were relatively less dominant than during the previous phase. The assembly fixtures faults caused 70% of the total number of failures. It is interesting to note

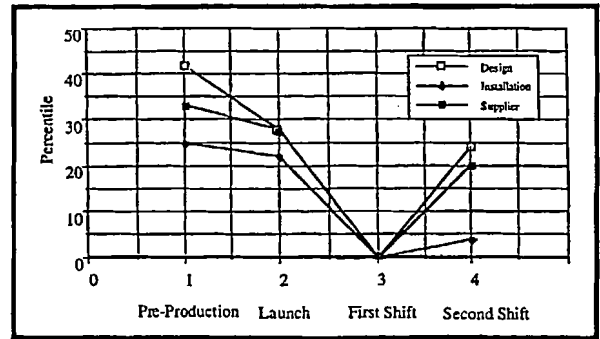

Fig. 12. Root cause patterns for the dimensional faults caused by design, installation and suppliers.

that the number of design, installation, and supplied panels related problems increased again. This can be explained by realizing that when the variation reaches its inherent level, further variation reduction requires changes in the product and processes.

Figures 12 and 13 summarize the detection of the tooling design discrepancies, installation mistakes, as well as supplied panels' inaccuracies during the production phases. Tooling design and installation discrepancies became one of the major root causes of the problems after the variation was reduced to 2.2 mm. This allows us to estimate that the 2.2-mm level was the tooling design capability of the process. Further reduction of variation to reach the 2-mm level required some tooling design modification.

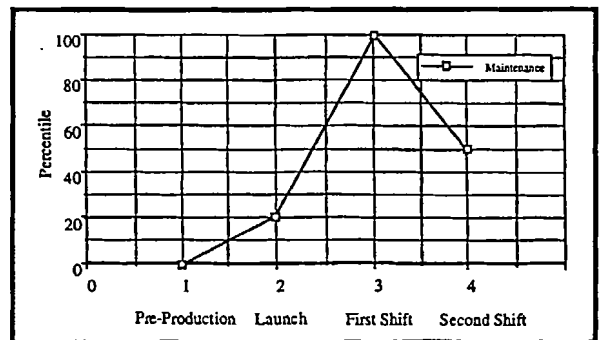

Fig. 13. Root cause pattern for the dimensional faults caused by maintenance.

Localization of Dimensional Variation within Assembly Process

The root cause based analysis presented in the previous section allows us to estimate the causes of dimensional variation. In addition to that, one of the most important issues is the localization of the variation within the assembly process: body-in-white subassemblies (underbody and side apertures), framing operations, and supplied panels. This classification is summarized in Figures 14 and 15.

Based on Figs. 14 and 15, it could be concluded that the variation reduction in the subassembly lines has a major impact on the variation of the body-in-white. In general, problems in subassembly are twice as frequent as those in the framing station. This indicates that for this particular design of the body-in-white, the subassembly is much more sensitive to variation than the final framing of subassemblies.

In addition, the cooperation and support from stamping operations played a major role in reducing dimensional variation. About one-fourth of the root causes were caused by the part suppliers.

Information Sources for Fault Detection

The analysis of the information sources is focused on the measurement and verification of gages such as: (1) Optical Coordinate Measuring Machine (OCMM), (2) Coordinate Measuring Machine (CMM), (3) visual observation, and (4) Theodolite gage.

Figure 16 shows the distribution of the information sources used for detection and analysis of the solved case studies. The measurement gage used most often to identify variation problems was the OCMM

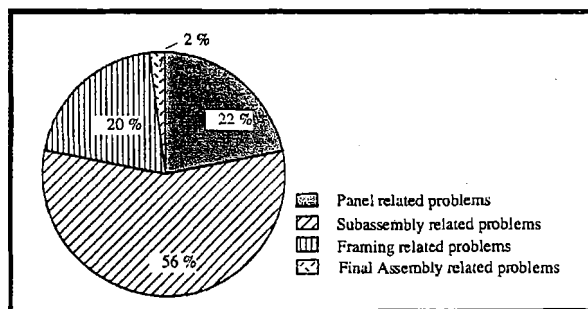

Fig. 14. Root cause classification based on the localization of the dimensional faults within the assembly process.

(56%). CMMs and Theodolites were each used in 19% of all case studies, mostly during analysis and verification of faults.

Summarizing the experience gained while solving these case studies, we concluded that information sources are used mainly for three purposes:

1. Detection and identification of the dimensional variation—OCMM, visual observation, and feedback from Final Assembly.
2. Analysis of already identified faults—OCMM and CMM.
3. Quantitative verification of the root cause of dimensional variation—CMM and theodolite.

The classification based on information source has been correlated largely with production phases. Figure 17 allocates different information sources to different production phases. This classification can be summarized as follows:

1. In-line measurement dominates as an information source during detection and analysis of the problems causing dimensional variation.
2. Most frequent application of CMM gage (35%) was during pre-production phase, when the volume of produced cars was small (small sample size).
3. Theodolite was used during launch phase (34%) for verification of tooling installation problems, and second shift phase (35%) for verification of tooling design modifications necessary to reach 2-mm variation level and not predicted earlier by designers.

CONCLUSIONS AND SUMMARY

There is a move to blend control of dimensional variation into the automotive industry. Within the automotive industry, it is viewed as assets able to create high quality product. This paper summarizes a developed methodology for reducing dimensional variation as well as a study on the root causes of variation. This study, conducted in one of the facilities of the leading auto manufacturers, was focused on obtaining the best-in-class dimensional automotive body build based on quality benchmark established as 2 mm (6-sigma). A

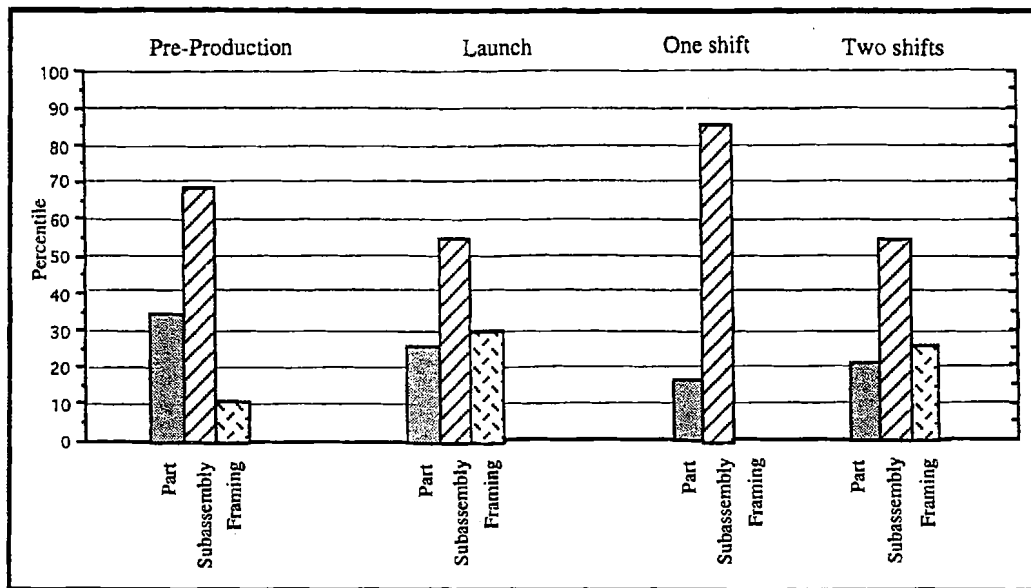

Fig. 15. Root cause classification based on the localization of the dimensional faults within the assembly process and occurrence during production phases.

data-driven, case-based approach was used in solving dimensional faults. An example of one case study is presented in the paper. All of the case studies necessary to achieve best-in-class dimensional variation were analyzed and classified according to the nature of the faults using four different criteria: (1) root causes of the faults, such as tooling design, installation, maintenance, or incoming material variation; (2) root causes in the different production phases, i.e., pre-launch, launch, and full volume production; (3) areas of body assembly process, i.e., subassembly, body framing, etc.; and (4) the information sources used to detect dimensional faults.

Most of the variation problems during the first 15

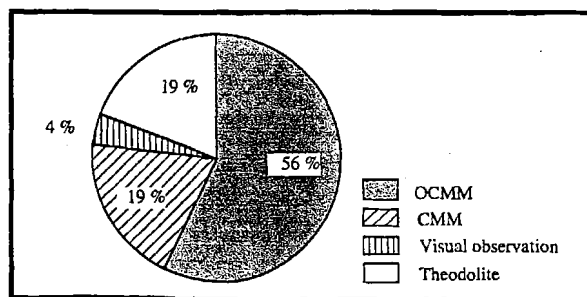

Fig. 16. Root cause classification based on the information source criterion.

months of the conducted test were caused by problems in product and process (tooling) design, tooling installation, tooling maintenance, and incoming material variation. Their relative contributions are classified according to the number of problems in each category:

- Tooling maintenance related problems: 37%.
- Product and process design related problems: 27%.
- Stamping panel related problems: 23%.
- Tooling installation related problems: 13%.

For all of the cases identified, sporadic problems or special cause problems (such as spikes) are as frequent as chronic problems or common cause problems (35% of total case studies). However, the underlying root causes for the majority of the sporadic problems are chronic in nature. These problems are induced by interference, either part/part interference or tooling/part interference.

As far as the root causes of variation during different production phases, findings related to the launch stage are as follows:

- Problems during pre-production and product launch are mainly related to design and installation, and are panel-related.

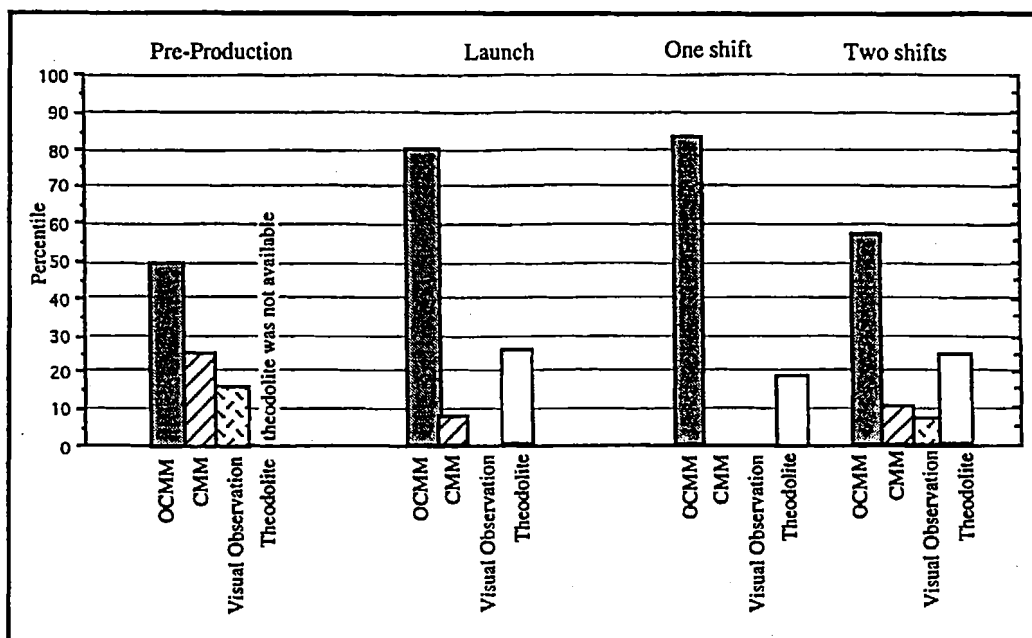

Fig. 17. Root cause classification based on the information source criterion and occurrence during production phases.

- During a new vehicle program, pre-production and product launch are the important phases in which to correct all dimensional problems and achieve the process capability.

Findings related to the full production stage are as follows:

- Each vehicle body has, as a result of product and process design, an inherent level of dimensional variation. Once the process reaches its inherent level of variation, further reduction of the dimensional variation on the body can be achieved. However, this can be done only through costly and time consuming product and process modification. In the case of the assembly plant where study was conducted, the dimensional capability is at 2.2 mm.
- Many problems in production stage are maintenance related. For example, during one shift production, all of the case studies identified were maintenance-related. During two shift production, 52% of the case studies were maintenance-related.

As for root causes of variation in different areas of the assembly process, subassembly variation contributes

most significantly to the variation of the body-in-white. In the conducted study, 56% of the problems are sub-assembly-related.

In evaluating the importance of measurement systems in fault identification and localization, the findings are:

- To successfully identify dimensional problems, sufficient measurement is necessary. For fast detection of the dimensional problems, use of in-line measurements is essential. For fault diagnosis, flexible measurement systems are important.
- To successfully verify dimensional problems in tooling, theodolites, or portable CMMs are necessary.

In terms of the development of the general methodology of solving dimensional variation problems, the findings are:

- A systematic, data-driven approach is essential during analysis of the dimensional problems.
- Fusion of assembly process knowledge with data-driven analysis is the key to fast identification of the root causes.

REFERENCES

1. Hopp, W.J., Spearman, M.L., Woodruff, D.L., "Practical Strategies for Lead Time Reduction," *Manufacturing Review*, **3(2)**: 78-84, 1990.
2. Ayres, R.U., "Complexity, Reliability, and Design: Manufacturing Implications," *Manufacturing Review*, **1(1)**: 26-35, 1988
3. Parkinson, A., Sorensen, C., Pourhassan, N., "A General Approach for Robust Optimal Design," *Trans. of ASME, Journal of Mechanical Design*, **115(1)**: 74-80, 1993
4. Gupta, Y.P., Kumar, S., "Controlling the Production Process Through Statistical Process Control," *Manufacturing Review*, **4(1)**:18-32, 1991
5. Barkan, P., Hinckley, C.M., "The Benefits and Limitations of Structured Design Methodologies," *Manufacturing Review*, **6(3)**: 211-220, 1993
6. Brannan, B., "Six Sigma Quality and DFA-DFMA Case Study/Motorola Inc., Boothroyd & Dewhurst DFM Insight, **2**:1-3, 1991.
7. Plonka, F.E., "A Methodology for Tolerancing, Process Evaluation and Control of Automobile Body Subassembly Designs," Ph.D. Dissertation, Univ. of Michigan, 1974
8. Baron, J., "Dimensional Analysis and Process Control of Body-In-White Processes," Ph. D. Dissertation, University of Michigan, Ann Arbor, 1992
9. Roan, C., Hu, S.J., Wu, S.M., "Computer Aided Identification of Root Causes of Variation in Automotive Body Assembly," *ASME Winter Annual Meeting*, 391-411, 1993
10. Hu, S.J., "Impact of 100% Measurement Data on Statistical Process Control (SPC) in Automobile Body Assembly," Ph. D. Dissertation, University of Michigan, Ann Arbor, 1990
11. Hu, S., Wu, S.M., "Identifying Root Causes of Variation in Automobile Body Assembly Using Principal Component Analysis," *Trans. of NAMRI*, **XX**: 311 -316, 1992
12. Roan, C., "Identification, Monitoring, and Diagnosis for Dimensional Control of Automobile Body Assembly," Ph. D. Dissertation, University of Michigan, Ann Arbor, 1993
13. Ceglarek, D., "Knowledge-Based Diagnosis for Automotive Body Assembly: Methodology and Implementation," Ph.D. Dissertation, University of Michigan, Ann Arbor, 1994
14. Ceglarek, D., Shi, J., Wu, S.M., "A Knowledge-based Diagnosis Approach for the Launch of the Auto-body Assembly Process," *Trans. of ASME, Journal of Engineering for Industry*, **116(4)**:491-499, 1994.
15. Shi, J., Hu, S.J., Ceglarek, D., "Process Navigator for the Automobile Body Assembly Process," *Proceedings of the First S.M. Wu Symposium on Manufacturing Science, Evanston Il*: 325-332, 1994.
16. Ceglarek, D., Shi, J., "Fixture Failure Diagnosis for Autobody Assembly Using Pattern Recognition," accepted for publication in the *Trans. of ASME, Journal of Engineering for Industry* simultaneously in *ASME Winter Annual Meeting*, **PED- 68**: 263-275, Chicago, Ill., November 6-11, 1994.
17. Takezawa, N., "An Improved Method for Establishing the Process-Wise Quality Standard" *Rep. Stat. Appl. Res., JUSE*, **27(3)**:63 -75, 1980.
18. Menassa, R.J., DeVries, W.R., "Locating Point Synthesis in Fixture Design," *Annals of CIRP*, **38(1)**: 165 -169, 1989.
19. Rearick, M.R., Hu, S.J., Wu, S.M., "Optimal Fixture Design for Deformable Sheet Metal Workpieces," *Trans. of NAMRI*, **XXI**:407 -412, 1993.
20. Datamyte Handbook, "A Practical Guide to Computerized Data Collection for Statistical Process Control," Allen-Bradley Co. Inc, 1993
21. Perceptron 1000, "System Manual," Perceptron Inc, 1991.
22. Greer, D., "On-line Machine Vision Sensor Measurements in a Coordinate System," *SME Paper #IQ88-289*, 1988.
23. Sekine, Y., Koyama, S., Imazu, H., "Nissan's New Production System: Intelligent Body Assembly System," *SAE Technical Paper Series*, No. 910816, pp. 1-12, 1991.

Dariusz Ceglarek is a research investigator at Department of Mechanical Engineering and Applied Mechanics at the University of Michigan. His research interests include quality control and assurance methodology with implementation; intelligent manufacturing, knowledge-based diagnosis using on-line fault detection and isolation with emphasis on automobile industry, application of AI in manufacturing. His current research is being sponsored by General Motors Corp., Chrysler Corp., National Institute Standard and Technology - Advanced Technology Program, and the National Science Foundation. He is a associate member of Society of Manufacturing Engineers, and American Society of Mechanical Engineers.

Jianjun Shi is the associate director of the S. M. Wu Manufacturing Research Center and a faculty member at Department of Mechanical Engineering and Applied Mechanics at the University of Michigan. His teaching and research interests include quality control and assurance methodology, systems, and its implementation; dynamic system modeling and control; intelligent manufacturing using on-line fault detection, isolation, and diagnosis with emphasis on automobile industry. His current research is being sponsored by General Motors Corp., Chrysler Corp., Auto Body Consortium, National Institute Standard and Technology - Advanced Technology Program, and the National Science Foundation. He is a member of Society of Manufacturing Engineers, and American Society of Mechanical Engineers.