

MONETARY POLICY AND INTERNATIONAL COMPETITIVENESS

(A story of smart speculators and sticky prices,
set in a world of high-speed capital movements)

Willem H. Buiter
(University of Bristol and N.B.E.R.)

Marcus Miller
(University of Warwick)

NUMBER 183

WARWICK ECONOMIC RESEARCH PAPERS

DEPARTMENT OF ECONOMICS

UNIVERSITY OF WARWICK
COVENTRY

MONETARY POLICY AND INTERNATIONAL COMPETITIVENESS

(A story of smart speculators and sticky prices,
set in a world of high-speed capital movements)

Willem H. Buiter
(University of Bristol and N.B.E.R.)
Marcus Miller
(University of Warwick)

NUMBER 183

October, 1980.

An earlier version of this paper was presented at the S.S.R.C. Money Study Group ninth Oxford Conference, September 23 1980. Our thanks are due to several participants in the Warwick Summer Workshop (particularly Stanley Black, Avinash Dixit, Paul Krugman and Nissan Liviatan) and to the N.B.E.R. Summer Institute for providing the opportunity to write an early draft of the paper. Buiter would like to acknowledge financial support from the N.S.F. Any opinions expressed are those of the authors and not those of the National Bureau of Economic Research.

This paper is circulated for discussion purposes only and its contents should be considered preliminary.

MONETARY POLICY AND INTERNATIONAL COMPETITIVENESS

Abstract

A model of Dornbusch is adapted to analyse the consequences for output and competitiveness of certain aspects of the U.K. government's medium term financial strategy and some other policy actions. This includes the announcement of a sequence of reductions in the target rate of monetary growth, an increase in VAT and a move to make the U.K. banking system more competitive. The impact of a discovery of domestic oil is also modeled. We consider the consequences of varying the degree of inertia in the underlying rate of inflation and of different rates of international capital mobility. A real interest rate equalization tax stabilizes the real exchange rate but not the level of output. Once and for all changes in the level of the nominal money stock to accommodate changes in the demand for real money balances prevent 'overshooting' of the real exchange rate and fluctuations in output. It may, however, undermine the credibility of an announced policy of monetary disinflation.

Willem H. Buiter
Department of Economics
University of Bristol
Alfred Marshall Building
40 Berkeley Square
Bristol BS8 1HY
England
Tel. 0272-24161

Marcus H. Miller
Department of Economics
University of Warwick
Coventry CV4 7AL
England
Tel. 0203-24011

I. Introduction

Most advocates of controlling the money supply as a cure for inflation are willing to concede that there is a lag between changes in the money supply and their effects on the price level. Thus, in evidence to the Treasury and Civil Service Committee [1980, p. 59] Milton Friedman put this lag at roughly two years "for the US, UK and Japan".

Some recent contributions of authors belonging to the "New Classical Macroeconomics" school^{1/} deny the existence of such a lag for fully perceived or anticipated changes in the money supply. In the U.K. this position has been adopted by Patrick Minford (Minford [1980]). We reject the efficient markets hypothesis that generates this short-run monetary neutrality proposition as a valid characterization of the operation of labour and product markets in an economy like the U.K. Instead we postulate inertia (sluggishness or stickiness) of the domestic price level or, in a variant of our basic model, of both the price level and its rate of change.^{2/} While the domestic price level is therefore always treated as predetermined, its rate of change is endogenous to the model via an augmented Phillips curve. To capture what appears to us to be the spirit of optimistic monetarist analysis, we assume in most of what follows that the rate of inflation responds ceteris paribus one-for-one to changes in the rate of growth of the nominal money stock. The case in which there is more inertia in the underlying or "core" rate of inflation is also considered.

Throughout our analysis we assume that the inflation equation, and the degree of nominal inertia it incorporates, is invariant under the policy changes

^{1/} See e.g. Lucas [1972, 1975], Sargent and Wallace [1975, 1976] and Barro [1976].

^{2/} Nominal stickiness due to long-term contracts is also characteristic of the labour market. This is not explicitly considered in our model.

and the other parameter changes that we consider. Endogenous changes in the degree of price stickiness in response to perceived changes in monetary policy etc., (say because of induced changes in contracting behaviour in labour and product markets) may qualify our results. They will not negate them unless instantaneous transformations of contracting procedures implausibly turn long-term contracts into the equivalent of a sequence of efficient spot contracts.

In the paper we analyse the consequences of stickiness in domestic costs and prices for the behaviour of international competitiveness and real output when the government announces a (previously unexpected) programme of reductions in the rate of growth of the nominal money supply. For the purposes of this exercise, we assume both that there exists a stable, simple and well-behaved demand for money function and that the money supply can be controlled precisely by the authorities. Recent events in the U.K. and in the U.S. cast considerable doubt on both these assumptions, but an attempt at resolving these issues is beyond the scope of our paper.

Even when there is an instantaneous response of the rate of inflation to (previously unanticipated) monetary deceleration, there is likely to be an immediate adverse jump in international competitiveness as the exchange rate jumps towards its new equilibrium path and in the process changes the "real" exchange rate. The mechanism that causes this is the interaction of an efficient international financial market and a sticky domestic price level (or an "inefficient" domestic output market). After the reduction in monetary growth the sluggish domestic price level gradually approaches its new lower equilibrium path. This path is characterized by a lower rate of inflation, corresponding to the lower rate of growth of money; it also has to lie sufficiently far below the new target path for the money supply to generate the larger long-run stock of real money balances that will be demanded at the lower steady state nominal interest rate. Initially financial capital is assumed to be perfectly mobile

~~internationally, with speculative and arbitrage transactions conducted by~~
economic agents endowed with rational expectations and perfect information about everything except for the policy and parameter changes discussed below. The exchange rate, unlike the domestic price level, is an asset price determined in an efficient market, and is free to jump in response to new information. After the announcement of the reduction in monetary growth, well-informed speculators cause the exchange rate to jump towards but not necessarily on to its new, lower equilibrium path. With the price level predetermined, this jump appreciation of the nominal exchange rate corresponds to a jump appreciation of the real exchange rate, a sudden loss of international competitiveness.

The combination of sticky prices, mobile capital and rational expectations in the foreign exchange market thus implies that even "gradualist" monetary policy actions can have significant transitional effects on the level of international competitiveness, and hence presumably on the sectors of the economy most exposed to international competition. While, as we shall see in Section III, mobile capital and rational exchange rate expectations are not necessary to produce large transitory swings in the real exchange rate, they are, when combined with sticky prices or wages, one empirically important source of such shocks to competitiveness.^{1/} Is the squeeze on the internationally competitive sector an inevitable consequence of the "gradualist" monetary cure? Is the observed sharp loss of competitiveness one of the "unpleasant side effects" of which Friedman and others have spoken, or has this come as an unanticipated shock? These are two of the questions to which this paper is addressed.

^{1/} Without sticky nominal prices, rational expectations and mobile capital are, of course, not even sufficient to produce real or nominal exchange rate overshooting.

At least since Dornbusch's 1976 paper on rational exchange speculation and sticky prices, the idea that the competitiveness may be prone to suffer from "jumps" of this sort has been widely canvassed (and we use his approach to discuss the consequences of monetary policy in this paper). Yet the behaviour of a floating exchange rate under monetary contractions gets rather cursory treatment in the evidence which Friedman supplies to the Committee on the Treasury and Civil Service earlier this year.

This may be seen from his answers to questions specifically addressed to the behaviour of the exchange rate under contractionary monetary policy. First in respect to an explicit question on whether the exchange rate is the principal "transmission mechanism" of monetary policy in the U.K. Friedman writes (Treasury and Civil Service Committee [1980, p. 61]):

"I strongly disagree. Monetary policy actions affect asset portfolios in the first instance, spending decisions in the second, which translate into effects on output and then on prices. The changes in exchange rates are in turn mostly a response to these effects of home policy {on output and prices?} and of similar policy abroad. The question is topsy turvey."

(parentheses added)

Second, on whether "the loss of price competitiveness on British exports and against foreign imports and/or the squeeze in profit margins because of the strong £ should be of concern to the authorities in their conduct of monetary policy", Friedman's answer is "No". Finally when asked whether the conduct of monetary policy would be assisted by limiting the opportunity or incentive for international financial capital movements, he says "No, hampered rather than assisted". (Treasury and Civil Service Committee [1980, p. 61]).

After spelling out the details of how monetary policy might affect the real exchange rate assuming perfect capital mobility in Section II below, we turn to look at what happens when capital mobility is limited, in Section III.

A special case of this is the complete absence of capital mobility. We call this "current account monetarism". If capital mobility is ignored and in addition the "augmentation" term in the Phillips curve is sluggish then there will be no discrete movements in the exchange rate or in competitiveness in response^{to} changes in monetary growth. This model, which we refer to as "Manchester current account monetarism", seems to give results which are closest to what Friedman said in evidence (and corresponds closely to what Laidler himself has written on an earlier occasion, Laidler [1975] - whence the label).

In response to the question on taxes on capital movements, Dornbusch wrote to the Committee (Treasury and Civil Service Committee [1980, p. 72]):

"It is quite apparent ... that both from the point of view of public finance and from the perspective of macroeconomic policy, a real interest equalisation tax is called for."

His emphasis on the need for such fiscal intervention can be appreciated from what he said earlier about the effects of an overvalued exchange rate (Treasury and Civil Service Committee [1980, pp. 71-72]):

"If pursued over any period of time the {high real exchange rate} policy will lead to a disruption of industry; reduced investment, shutdowns, declining productivity, loss of established markets and a deterioration of the commercial position."

(parentheses added)

In a recent paper Nissan Liviatan [1980] also recommends a tax on capital inflows (a subsidy to capital outflows) as a desirable accompaniment to monetary contraction, and Flood and Marion [1980] argue the virtues of a two-tier exchange rate in these circumstances.

In the last Section of the paper therefore, we show what happens when such a tax is included in a model where capital is otherwise perfectly mobile. It is shown that a tax that equalizes after-tax real rates of interest is equivalent to a real exchange rate stabilization tax and that, at any rate

in our model, this tax takes a rather simple form. Thus, perhaps not surprisingly, the highly open economy model, when insulated by such a tax, generates behaviour not very different from the current account monetarist model with sluggish "core" inflation.

If indeed the U.K. government and its advisers have been operating with an approach to monetary policy which ignores the role of international capital mobility then the analysis in this paper will explain how on this occasion the speculators have had the jump on the "gradualists". By way of conclusion, we indicate how monetary authorities who adopt fixed growth rate rules for the money stock can beat the speculators - by appropriate jumps in the level of the money stock.

II. Real balances, the real exchange rate and monetary policy

The model

In this Section a simple macroeconomic model of a small economy in a world of freely floating exchange rates is specified in which the exchange rate is determined by the actions of risk neutral speculators possessed of rational expectations and perfect information about the parameters of the model (including those describing government behaviour). The basic specification is derived from recent papers by Dornbusch [1979] and Liviatan [1980]; it can be used as a convenient and tractable vehicle for discussing the effects of monetary policy in an open economy. (We also include some discussion of the effects of discovering oil on the exchange rate).

The log-linear equations of the model are as follows:

- (1) $m = k(y + \rho) - \lambda(r - r_d) + p + \theta; \quad k, \lambda > 0$ (LM curve)
- (2) $y = -\gamma(r - Dp) + \delta(e - p) + \chi\rho_\infty; \quad \gamma, \delta > 0$ (IS curve)
- (3) $Dp = \phi y + \Pi; \quad \phi > 0$ (Phillips curve)
- (4) $\Pi = \mu$ (Core inflation)
- (5) $De = r - r^* - \tau$ (Covered interest parity)

List of symbols

m	logarithm of the nominal money stock	exogenous
p	logarithm of the domestic price level "at factor cost" i.e. excluding indirect taxes	
y	logarithm of real non-oil domestic income (zero represents "high employment" real income)	
ρ	oil production expressed as a fraction of real non-oil income (assumed to be constant and lasting only a few years)	exogenous
ρ_∞	permanent income equivalent of ρ ($\rho_\infty < \rho$)	exogenous
r	domestic nominal interest rate on non-money assets	
r_d	nominal rate of interest paid on domestic money	
r^*	foreign nominal interest rate on non-money assets	exogenous
θ	rate of indirect tax	exogenous
e	logarithm of the exchange rate (domestic currency price of foreign currency)	
Π	trend or "core" rate of inflation	
μ	rate of growth of the domestic nominal money supply; $\mu \equiv Dm$	exogenous
τ	rate of tax on capital inflows (subsidy on outflows)	exogenous
D	is the differential operator, so for example	
	$Dm \equiv \frac{dm}{dt}$	

The first equation describes the condition for equilibrium in the money market : the demand for nominal money balances depends on real income (from non-oil production and from oil production, assumed to be a fixed percentage, ρ , of non-oil production), the opportunity cost of holding money $(r - r_d)$ and the price level net of taxes, p , plus the rate of indirect tax θ .^{1/}

The condition for equilibrium in the market for non-oil production is given next : output is demand-determined and, after eliminating the effect of non-oil income, demand depends on the instantaneous real rate of interest $(r - Dp)$, the real exchange rate $(e - p)$ and permanent real income from oil production, ρ_ω .^{2/}

Inflation is generated by an augmented Phillips curve and so depends on the level of (non-oil) production, and the trend or "core" inflation rate (Π) . For simplicity the explicit dependence of the domestic price level on the exchange rate and the price of foreign goods is ignored in this paper.^{3/}

Trend or core inflation is assumed to equal the rate of monetary expansion, a constant denoted by the letter μ . Finally, we have the condition for equilibrium in the foreign exchange market, which is characterised by risk-neutral speculators endowed with perfect information and infinitely-elastic covered interest arbitrageurs. As a result, the uncovered interest

-
- 1/ Permanent income and the expected rate of inflation could be included as arguments in the money demand function without qualitatively altering our results.
- 2/ Permanent income from non-oil production is identified with its long-run equilibrium or steady-state value. This equals 0 in the model.
- 3/ The qualitative properties of the model are not affected by this simplification. See Buiters and Purvis [1980].

differential in favour of the domestic country, net of any tax on capital imports, must equal the forward discount on the currency; and the forward discount must, in the absence of unannounced exogenous changes, accurately forecast the change in the spot rate.

It will be convenient in what follows to define explicit variables for the level of real balances and for the real exchange rate as follows:

$$\left. \begin{aligned} l &\equiv m - p \\ c &\equiv e - p \end{aligned} \right\} \text{ where } p \text{ is the price level } \underline{\text{net}} \text{ of indirect taxes.}$$

The first of these is a measure of the liquidity in the economy (though it does not, by construction, take account of indirect taxation); the second is a measure of international competitiveness - if the price of foreign currency, e , is high relative to the domestic price level, p , (excluding VAT) then, for given foreign prices, domestic producers will be in a favourable competitive position.

The dynamics of adjustment

Using these definitions we may rewrite the structural equations in matrix form:

$$(6) \quad \begin{bmatrix} D & 0 & \phi & 0 \\ 0 & D & \phi & -1 \\ 1 & 0 & -k & \lambda \\ 0 & -\delta & 1-\theta\gamma & \gamma \end{bmatrix} \begin{bmatrix} l \\ c \\ y \\ r \end{bmatrix} = \begin{bmatrix} 0 \\ -\mu - r^* - \tau \\ \theta + \lambda r_d + k\rho \\ \gamma\mu + \chi\rho_\infty \end{bmatrix}$$

The last two equations are simply the LM and IS curves (1) and (2) above. The other two describe the evolution of liquidity and competitiveness by combining the augmented Phillips curve with the money growth parameter and with the interest parity condition respectively. The income and interest rate variables can be eliminated to obtain a two equation reduced form in liquidity and competitiveness, as follows:

$$(7) \begin{bmatrix} D\ell \\ Dc \end{bmatrix} = \begin{bmatrix} a_{11} & a_{12} \\ a_{21} & a_{22} \end{bmatrix} \begin{bmatrix} \ell \\ c \end{bmatrix} + \begin{bmatrix} b_{11} & b_{12} & b_{13} & b_{14} & b_{15} & b_{16} & b_{17} \\ b_{21} & b_{22} & b_{23} & b_{24} & b_{25} & b_{26} & b_{27} \end{bmatrix} \begin{bmatrix} \mu \\ r^* \\ \tau \\ \theta \\ r_d \\ \rho \\ \rho^\infty \end{bmatrix}$$

where the elements of the matrices A and B are given in detail in Table 1.

Table 1

The structural coefficients corresponding to equation (7) $\begin{bmatrix} D\ell \\ Dc \end{bmatrix} = A \begin{bmatrix} \ell \\ c \end{bmatrix} + Bx$ are

$$A = \frac{1}{\Delta} \begin{bmatrix} \phi\gamma & \phi\lambda\delta \\ 1 & \delta(\phi\lambda-k) \end{bmatrix} \quad B = \frac{1}{\Delta} \begin{bmatrix} \phi\lambda\gamma & 0 & 0 & -\phi\gamma & -\phi\gamma\lambda & -\phi\gamma k & \phi\lambda\chi \\ \lambda & -\Delta & -\Delta & -1 & -\lambda & -k & -(k-\phi\lambda)\chi \end{bmatrix}$$

where, x, the exogenous variables are $[\mu \quad r^* \quad \tau \quad \theta \quad r_d \quad \rho \quad \rho_\infty]'$

and $\Delta = \gamma(\phi\lambda-k) - \lambda$ and is assumed to be negative throughout the paper.

(The effects of the change in sign of $\phi\lambda-k$ as ϕ and λ vary is discussed in the text).

Table 2

The reduced form coefficients corresponding to equation (8) $\begin{bmatrix} \hat{l} \\ \hat{c} \end{bmatrix} = R x$ are

$$R = \begin{bmatrix} -\lambda & -\lambda & -\lambda & 1 & \lambda & k & 0 \\ 0 & \gamma/\delta & \gamma/\delta & 0 & 0 & 0 & -\frac{\lambda}{\delta} \end{bmatrix}$$

where x is defined as in Table 1.

The dynamic behaviour described by this system is illustrated in Figure 1. For given values of the exogenous variables the paths followed by liquidity and competitiveness depend on the matrix A. From the values given for the second row of the matrix in Table 1 we find that $Dl = 0$ implies

$$\left. \frac{dc}{dl} \right|_{Dl=0} = \frac{-\gamma}{\delta\lambda} < 0. \quad \text{The locus of the stationary value of } l \text{ is labelled}$$

LL in the figure. The arrows show liquidity declining to the north east of LL, where high levels of real balances and competitiveness (and so high demand pressure) lead to inflation which exceeds the fixed rate of growth of nominal money. From the values given for the first row of A we find that the locus of stationary values for the real exchange rate drawn as CC in Figure 1 has the slope $\left. \frac{dc}{dl} \right|_{Dc=0} = \frac{1}{\delta(k-\phi\lambda)}$ whose sign depends on the size of ϕ , the coefficient in the Phillips curve. For low values of ϕ CC slopes positively. As ϕ increases CC rotates anti-clockwise so the slope becomes infinite then negative.

The exchange rate (and therefore competitiveness) is a forward-looking or "non-causal" variable. As it is a price that clears an efficient international financial market it is not a predetermined state variable. It is free to make discrete jumps at a point in time in response to "news". "News" includes all previously unanticipated current or future changes in exogenous variables and

Figure 1 The dynamic behaviour of real balances and competitiveness

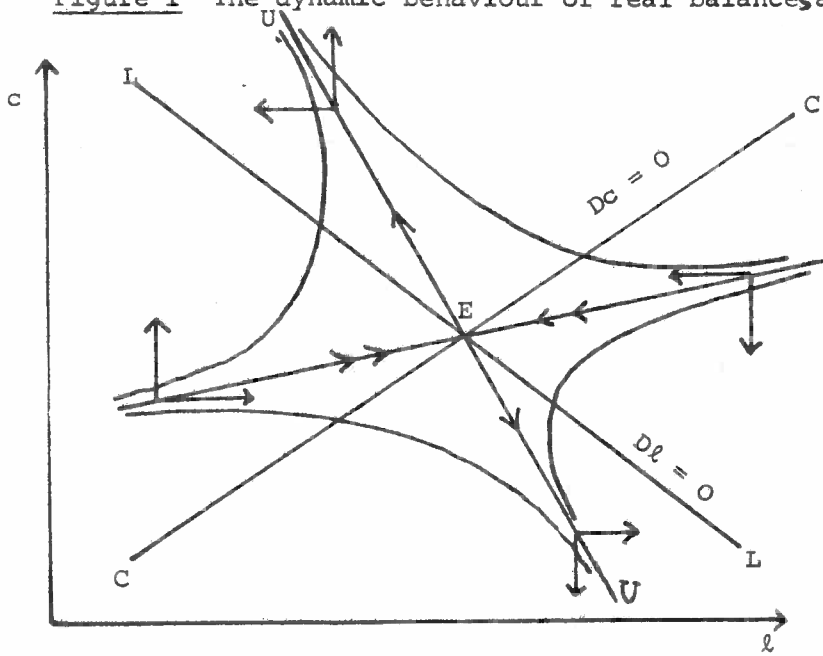

Figure 1A

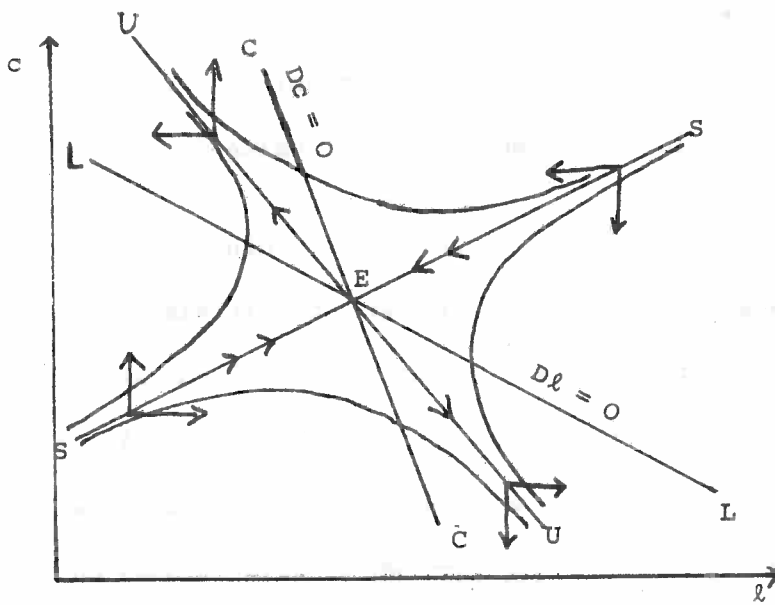

Figure 1B

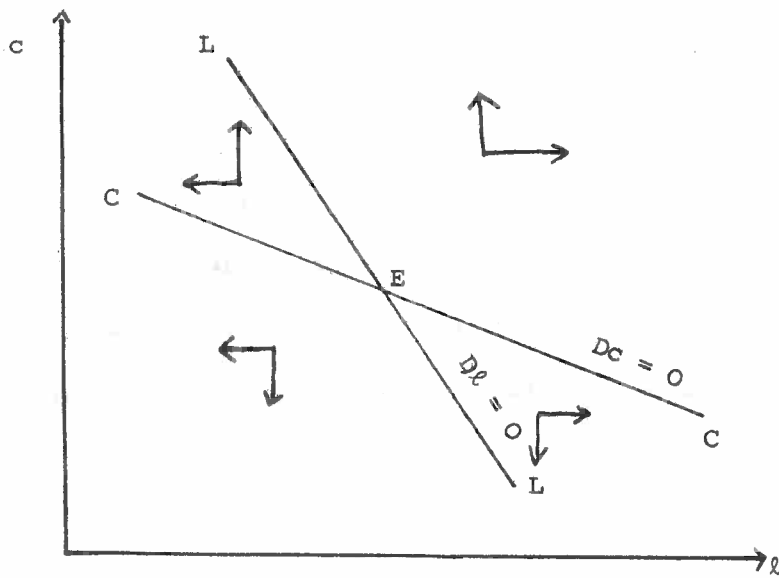

Figure 1C

policy instruments. Since e and c can make discrete jumps, D_e and D_c are to be interpreted as right-hand side time derivatives of e and c . This agrees with economic intuition because the current value of the forward-looking variable e (and its rate of change) are found by solving forwards in time for the entire (expected) future path of e . This in contrast with the backward-looking or "causal" variables p and l that are predetermined at a point in time and are continually "updated" by dynamic equations for D_p and D_l . In a dynamic linear model with n_1 backward-looking and n_2 forward-looking variables, there exists a unique saddle-path converging to the long-run equilibrium provided there are n_1 stable characteristic roots (the ones "corresponding to" the n_1 predetermined variables) and n_2 unstable characteristic roots (the ones "corresponding to" the n_2 jump variables). In our two equation dynamic model with one causal and one non-causal variable, the existence of a unique convergent saddle path therefore requires the presence of one stable and one unstable root. The assumption of long-run and short-run perfect foresight and the transversality condition that rational agents will not choose an unstable solution mean that the jump variable (e or c) will always assume the value required to put the system on the unique convergent solution trajectory.

For there to be one stable and one unstable root it is necessary and sufficient that the determinant of A be negative, i.e. that $\frac{\phi\delta}{\Delta} < 0$. We show below that $\Delta < 0$ is necessary and sufficient for an increase in aggregate demand to raise output at a given level of competitiveness. As $\Delta = \gamma(\phi\lambda - k) - \lambda = \lambda(\gamma\phi - 1) - \gamma k$, a sufficient condition for the long-run equilibrium to be a saddlepoint is a sufficiently small value of ϕ , the slope of the short-run Phillips curve. The equilibrium will always be a saddlepoint if the $D_c = 0$ locus is upward sloping ($\phi\lambda - k < 0$). This case is illustrated in Figure 1A. Even if the $D_c = 0$ locus is downward-sloping, the equilibrium can be a saddlepoint provided the $D_c = 0$ locus is steeper than the

$D\dot{l} = 0$ locus. This case is drawn in Figure 1B. Note that the condition that the downward-sloping $Dc = 0$ locus be steeper than the downward-sloping $D\dot{l} = 0$ locus $\left(\left| -\frac{\gamma}{\delta\lambda} \right| < \left| \frac{1}{\delta(k-\phi\lambda)} \right| \text{ where } k - \phi\lambda < 0 \right)$ is simply the condition that Δ be negative. If ϕ is very large and Δ becomes positive, the $Dc = 0$ locus is downward-sloping and less steep than the $D\dot{l} = 0$ locus. In this case the equilibrium ceases to be a saddlepoint and is completely unstable instead. Figure 1C illustrates this. A completely stable system is ruled out for our model, but this is just as well. Such a comforting configuration in a model comprising only backward-looking variables would be very disconcerting in a model including forward-looking variables. With two stable roots the transversality or terminal condition that the model converges to equilibrium can no longer determine a unique initial condition for e and c . There is a continuum of values of c for any given value of the predetermined variable l that converge to equilibrium. In what follows we rule out the case of Figure 1C from further consideration and assume $\Delta < 0$ throughout. Both Figures 1A and 1B show qualitatively similar behaviour for l and c . To the east of CC liquidity is high, so interest rates will be low, but low interest rates are associated with appreciating currencies in a world of high capital mobility, so the arrows show competitiveness declining to the east of CC. Both Figures 1A and 1B show a unique upward-sloping saddlepath SS converging to the equilibrium.^{1/}

Our assumption that the economy is stable places it on SS. In terms of the figure, the stickiness of the price level (though not of its rate of change) together with the assumption that the money supply is exogenously determined means that real balances are, at any time, given by past history, and it is the real exchange rate which adjusts, by jumps in the nominal exchange rate, so as to put the economy on SS.

^{1/} The unstable root defines the locus UU.

The long run impact effects of monetary policy

The long and short run effects of various monetary policy actions can now be analysed. Formally, the long run equilibrium values of liquidity and competitiveness, denoted \hat{l} and \hat{c} , can be found by setting Dl and $Dc = 0$ and solving the equation

$$\begin{bmatrix} \hat{l} \\ \hat{c} \end{bmatrix} = -A^{-1} B x \equiv R x$$

where x , the vector of exogenous variables, is given by : $x' = [\mu, r^*, \tau, \phi, r_d, \rho, \rho_{\omega}]$. The coefficients of the reduced form matrix R , which show the long run effects of exogenous changes, are shown in Table 2.

The long run effects of three contractionary monetary policy actions can be seen very easily as in the lower panel of Figure 2, which shows the demand curve for real balances as a function of the nominal rate of interest on non-money domestic assets.

A reduction in μ , the rate of monetary expansion, will in the long run reduce the domestic nominal rate of interest by the same amount, and so will shift the system from an initial equilibrium at point A, for example, to a new equilibrium at point B. Real liquid balances will increase accordingly by an amount determined by the slope of the demand for money, so $dl = -\lambda d\mu$ i.e. the percentage increase in real balances will be the % fall in monetary growth multiplied by the "semi-elasticity" of demand.

An increase in the demand for real balances due to a reduction in τ or an increase in θ or r_d will shift the demand curve over to the right as shown in the figure. If for example, the rate of indirect taxation

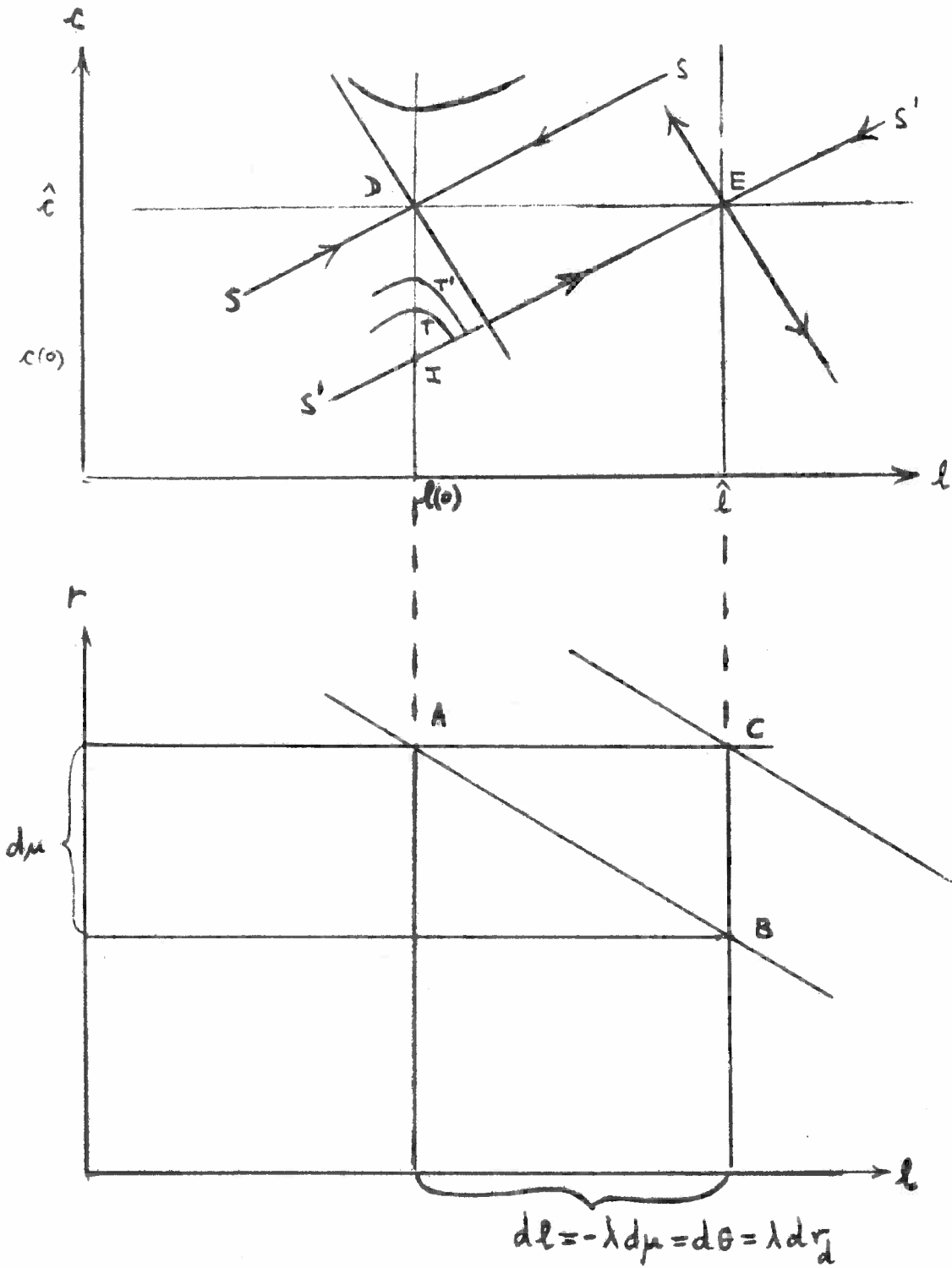

FIGURE 2 The impact and long-run effects of contractionary monetary policy

were to be increased,^{1/} then the desired ratio of money balances to prices net of indirect tax would increase by the same percentage which would appear as a shift in the demand curve in Figure 2. Since a change in the standard rate of VAT in the UK changes the average rate of indirect tax by half as much (as many goods escape VAT), a rise of VAT by 8% would increase market prices by about 4% (given factor costs) and so would shift the demand curve in the figure by 0.04. In the absence of monetary accommodation restoration of long-run equilibrium requires the path followed by factor costs to fall so that market prices return to the path they followed before the VAT increase. Since the trend rate of monetary growth has not increased, there will be no change in the equilibrium rate of interest, so the new equilibrium at C will be horizontally to the right of A.

Another change which will shift the demand for money schedule in Figure 2 is an increase in r_d , the rate of interest paid on money. An increase in competition in banking (as was encouraged in the UK by the regime of Competition and Credit Control in 1971 for example) may be expected to lead to an increase in the rates paid on bank deposits. In the Bank of England Quarterly Bulletin of September 1974, Graham Hacche observed that:

"Although the MC {i.e. company holdings of M_3 } and M_3 {i.e. broad money} equations estimated before the introduction of the new approach failed to forecast subsequent behaviour at all accurately, it has been found that equations which fit the data to the end of 1972 quite well may be obtained by inclusion of the CD rate over part of the period. This supports the argument that the own rate on money became a more significant and powerful determinant of demand for M_3 from the end of 1971 onward."

Hacche [1974] p. 296

(parentheses added)

^{1/} By assuming offsetting fiscal action by the authorities, we ignore the effects of changes in indirect tax on aggregate demand - cf. the 1979 budget.

On the basis of this argument, increased competition would increase the demand for money by λdr_d , by the semi-elasticity of demand times the change in the own rate. In June 1980 Greenwell's Bulletin suggested a figure of about 5% for the amount of reintermediation that might follow the removal of the corset which had checked competition in banking. This effect could be captured by setting $\lambda dr_d = 0.05$. (For diagrammatic convenience we assume in Figure 2 that the rightward shift of the money demand function is the same for the changes in θ and in r_d and that the equilibrium increase in ℓ is the same for the changes in μ , θ and r_d .) It has been argued by others, notably by Tobin and Brainard [1963], that the effect of competition in banking is not simply to raise r_d , but to link it to market interest rates and so make it endogenous. If r_d is endogenous and moves with r , then the effect of r on the demand for money correspondingly falls and the LM curve becomes steeper. Many of the effects of an increase in MLR are also captured by an increase in r_d as the deposit rate is tightly linked to MLR.

We assume that all policy changes (and other shocks) are unanticipated until they are "announced". When we come to look at the impact effects of these policies it is necessary to specify whether they are implemented when they are announced or whether there is some delay in implementation. Assuming that announcement and implementation are simultaneous, then the impact effect on the exchange rate can be shown in the upper panel. (All the policies shown in the lower panel will simply shift the long-run equilibrium from D to E. As can be confirmed from Table 2, none of these policies change the equilibrium real exchange rate - although they would if a real balance effect were included in the aggregate demand equation).

The stable path leading to E is shown as S'S'. Since the level of real balances cannot change discretely, the level of competitiveness must fall

from its initial level of \hat{c} to $c(0)$ as shown by point I in the figure.

~~It is the intersection of the stable path S'S' and the initial condition~~
 $l = l(0)$ which determines the initial level of competitiveness and hence the jump it makes in response to exogenous changes.

If the authorities announce a monetary policy action which they say will be implemented after a delay then, at the time of announcement, there will be a jump in the level of competitiveness, but by less than if the action were implemented immediately. Following Wilson [1979], we can show this in Figure 2 by noting that there are an infinite number of paths leading from $l(0)$ to the line shown as S'S'. Two such paths are shown labelled as T and T', where the label indicates how long it takes to get from $l(0)$ to S'S', and $T' > T$. For any given delay of length T between announcement and implementation, the exchange rate will jump to that path which takes an interval of length T to reach S'S. Consequently when the policy is actually implemented, the exchange rate will be placed on the convergent path and will not have to "jump" onto it. The mathematical treatment of anticipated future changes in exogenous variables is given in Appendix 4.

The medium term financial strategy and the credibility of policy announcements

The centrepiece of the medium term financial strategy announced by the present Conservative administration is the sequence of annual one point reductions in (the target range for) monetary growth planned for the next four years. Following the same principles as described above, one can portray the response of the system to such a strategy as in Figure 3. The (unanticipated) reduction of monetary growth in the first year would, if implemented immediately, lower competitiveness down to point A on S_1S_1 ; but allowance has also to be made for the present effects of the announced future policy. With rational expectations, the system should follow a path which will, without future jumps in competitiveness, end up on S_4S_4 , the stable locus associated with the fourth (and subsequent) years of the strategy. There is no way of getting from a point such as A on to the south west branch of paths such as S_2S_2 , S_3S_3 , S_4S_4

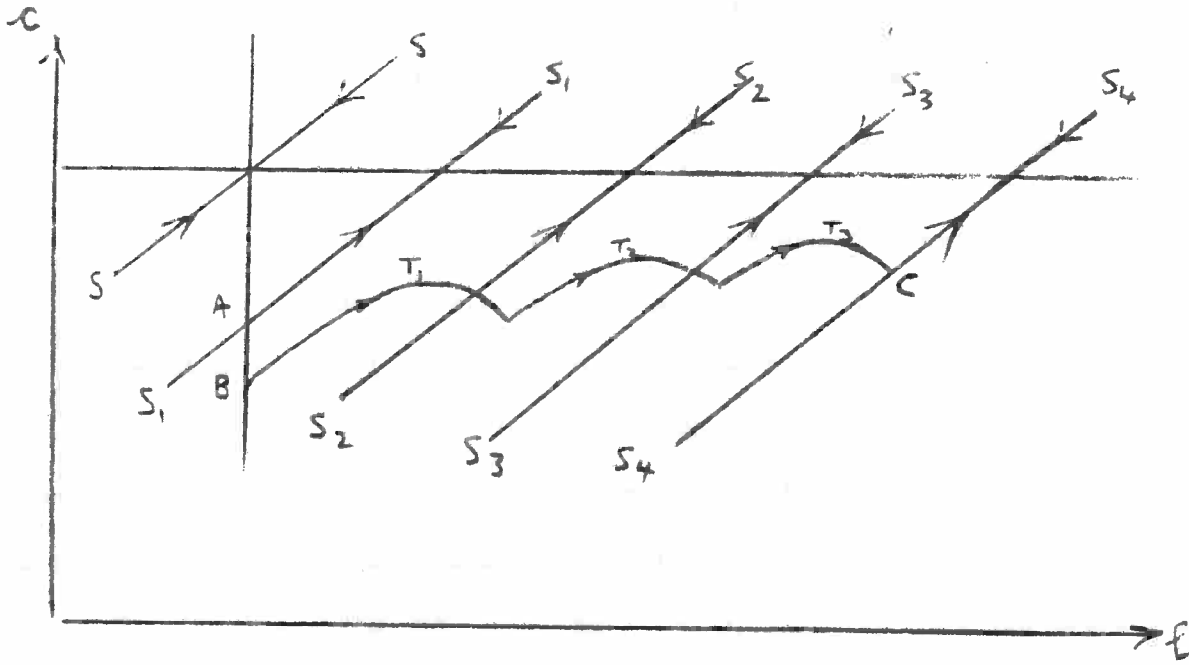

FIGURE 3 The Medium Term Financial Strategy

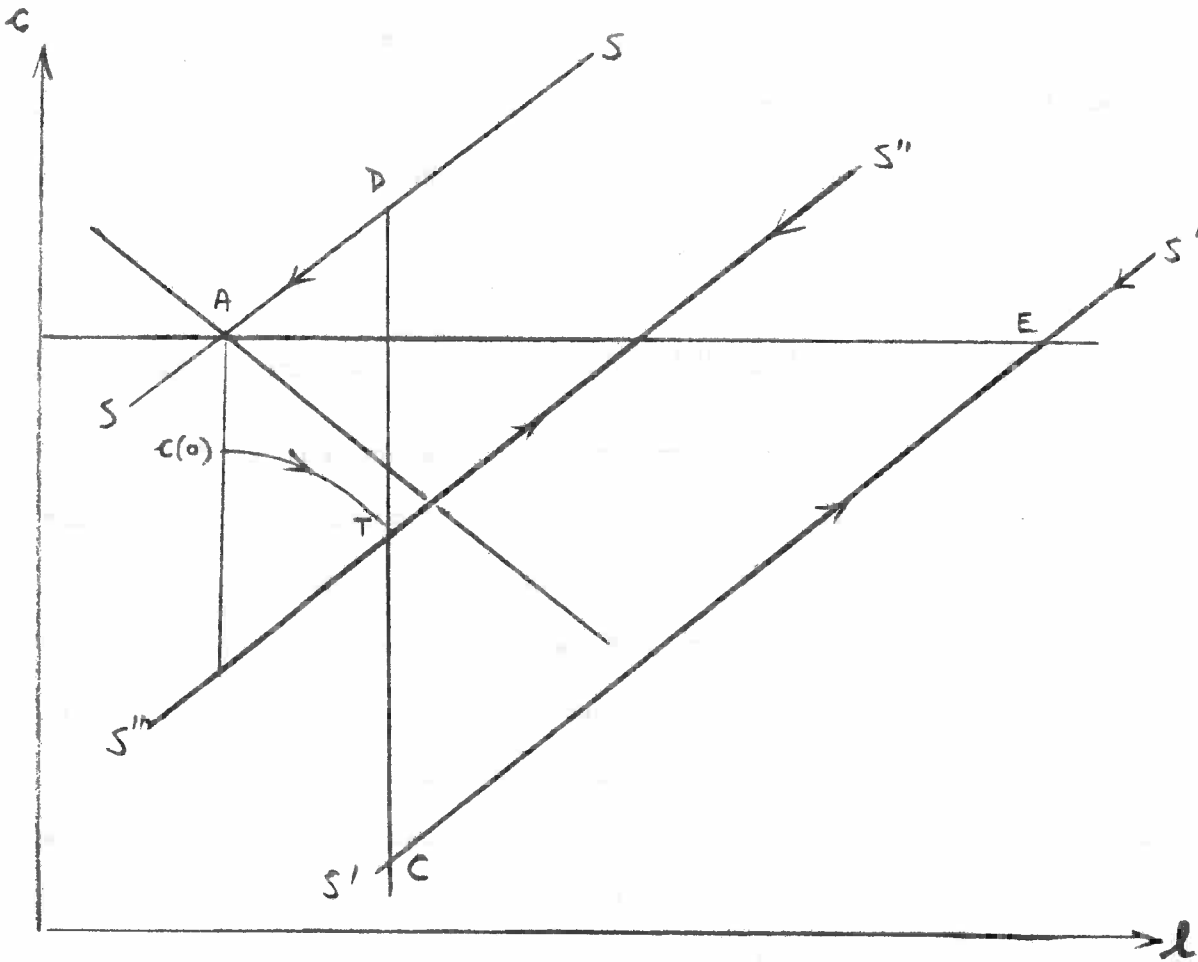

FIGURE 4 The effect of not-wholly-credible policy announcements

without a jump, so competitiveness must initially fall further than A. We have therefore chosen an initial value of B which leads to a sequence of connected, one-year-long paths, each "driven" by the level of monetary growth prevailing in the year in question, which will put the system at point C on $S_4 S_4$ as the fourth and final year of the medium term strategy dawns.^{1/}

The absence of "jumps" in the path shown satisfies the requirement that there should be no unexploited profit opportunities. The presence of the "humps" or kinks reflects of course the discontinuous nature of a gradualist policy which lowers monetary growth in steps. If the reduction in monetary growth were smooth (as described by $D\mu = -a\mu$ for example) then the exchange rate path would be correspondingly smoothed, and in the numerical examples below we consider the consequences of such a policy (of "crawling gradualism") for the initial level of competitiveness.

So far we have assumed both that the Government carries out its announced policy and that the public firmly believes that it will. But what if policy announcements are not wholly believed? One simple way of analysing the case of a not-wholly-credible announcement of a change in monetary growth T periods in the future, is to assume that agents in the private sector attach probability weights w and 1 - w, $0 < w < 1$, to two possibilities, first that the policy is implemented at time T as announced to-day and second that there is no change in policy at time T. This will lead to an "expected" rate of monetary growth for time T, $\mu^e(T) = w\mu(0) + (1 - w)\mu^a(T)$, where $\mu^a(T)$ is the announced figure. In this case, the exchange rate would jump on to the path which will

^{1/} Will this be a time of which some poet will be moved to write: "Glorious was it in that dawn to be alive, but to be young was very heaven"? With rational expectations, of course, he will have penned his lines long before then!

take the system to the point corresponding to the "expected" rate of monetary growth at the time T periods from the announcement. This is shown in Figure 4 where the path towards which the speculators push the system is shown as $S'S$ and competitiveness jumps to $c(0)$.

At time T , the truth will out, and agents will discover which of the two prospects is correct. If their scepticism was misplaced then the exchange rate will jump the rest of the way to $S'S'$ arriving at point C , from which it will proceed towards E . If the authorities do in fact fail to carry out the policy, then the international value of domestic currency will fall. This will push competitiveness up to D , and the system will then proceed back to the initial equilibrium at A , from which it has been misled by false information.

The consequences of inertia in the "core" rate of inflation

So far we have assumed that the trend or core rate of inflation, denoted by Π , matches the rate of monetary growth, μ so that when there is a monetary slowdown, the rate of wage and price inflation falls immediately by the same amount, even without any recession; the latter will cut the rate of inflation even further.

Most monetarists would be willing to allow for some delay between the slowdown in monetary growth and its effect on core inflation. For example, both Friedman and Laidler in their evidence to the House of Commons Committee on the Treasury talked of a delay before monetary policy affected "expected inflation" - which is how they refer to the core rate of inflation. As we will see in more detail below, the assumption that core inflation does respond instantly implies a bigger fall in the nominal interest rate on the initiation of a monetary slowdown then seems plausible.

In this section, therefore, we examine how the existence of a lag of length T between the policy action and the effect on the trend rate of inflation affects the analysis. The way we proceed is first to see what would happen if there was a monetary slowdown and trend inflation never adjusted; and second to allow for expectations that full adjustment will come after a delay of T periods, (with no adjustment till then).

If there was never any change in Π , despite a fall in μ , then the system would not approach a full employment equilibrium with a lower rate of inflation, as has previously been the case. The equilibrium will exhibit the same, lower rate of inflation as before, but a permanent recession will be necessary to compensate for the unyielding inflationary psychology now postulated. As the real rate of interest must equal the world real rate of interest in equilibrium, this recession must be associated with a lower level of international competitiveness than the initial equilibrium; and, as the nominal rate of interest must equal the world real rate plus μ in the long run, the recession will reduce the demand for real balances relative to what they would be at full employment output.

Ignoring exogenous variables other than μ and Π , the dynamic reduced form of the model is given by:

$$\begin{bmatrix} D\ell \\ Dc \end{bmatrix} = \frac{1}{\Delta} \begin{bmatrix} \phi\gamma & \phi\lambda\delta \\ 1 & \delta(\phi\lambda-k) \end{bmatrix} \begin{bmatrix} \ell \\ c \end{bmatrix} + \frac{1}{\Delta} \begin{bmatrix} \Delta & \gamma k + \lambda \\ 0 & \lambda \end{bmatrix} \begin{bmatrix} \mu \\ \Pi \end{bmatrix}$$

The long run equilibrium change in ℓ and c when μ changes but Π remains constant is given by:

$$\frac{d\hat{\ell}}{d\mu} = \frac{-(\phi\lambda-k)}{\phi}\mu$$

and

$$\frac{d\hat{c}}{d\mu} = \frac{1}{\phi\delta}\mu .$$

Thus, c unambiguously falls when μ is reduced while l increases if $\phi\lambda - k > 0$ and decreases if $\phi\lambda - k < 0$ (i.e. if the $Dc = 0$ curve is upward-sloping). The ambiguity of the effect on l relative to the initial equilibrium is due to the fact that the lower steady-state nominal interest rate and the lower level of output affect the demand for real balances in opposite directions. Rather than going through the entire catalogue of possible configurations, we shall present a single example. Figure 5 is drawn on the assumption that $\phi\lambda = k$, i.e. that there is no long-run change in money balances. The initial long-run equilibrium is at A. If $\bar{\pi}$ changes by the same amount as μ , the new equilibrium would be E. If only μ changes, the long-run equilibrium is at E'. The saddlepath through E is SS, that through E' is S'S'. The effects of a delay of length T in the adjustment of $\bar{\pi}$ to μ can now be described in Figures (5a) and (5b). If core inflation never adjusts, an unanticipated monetary growth reduction from an initial equilibrium at A will immediately worsen the level of competitiveness to E' which is also the new long-run equilibrium.^{1/} The jump of c from A to E' can either exceed (as in Figure 5a) or fall short of (as in Figure 5b), the jump on to the saddlepath SS through E that would occur if $\mu = \bar{\pi}$ at each point in time. If speculators correctly anticipate a delay of length T before core inflation adjusts, the level of competitiveness will fall to a point between E' and I which we have labelled D. From there it will proceed along the unstable path shown as DT which arrives on the converging path SS through E after a period of length T. Hence when the rate of core inflation does adjust after an interval T, the exchange rate will not need to make any discrete adjustment in order to follow the new path SS thereafter.

^{1/} If steady state real money balances are not invariant under changes in μ , c will jump to the point on S'S' given by the predetermined level of l . The system will then gradually move to E' along S'S'.

Figure 5 The consequences of inertia in the "core" rate of inflation

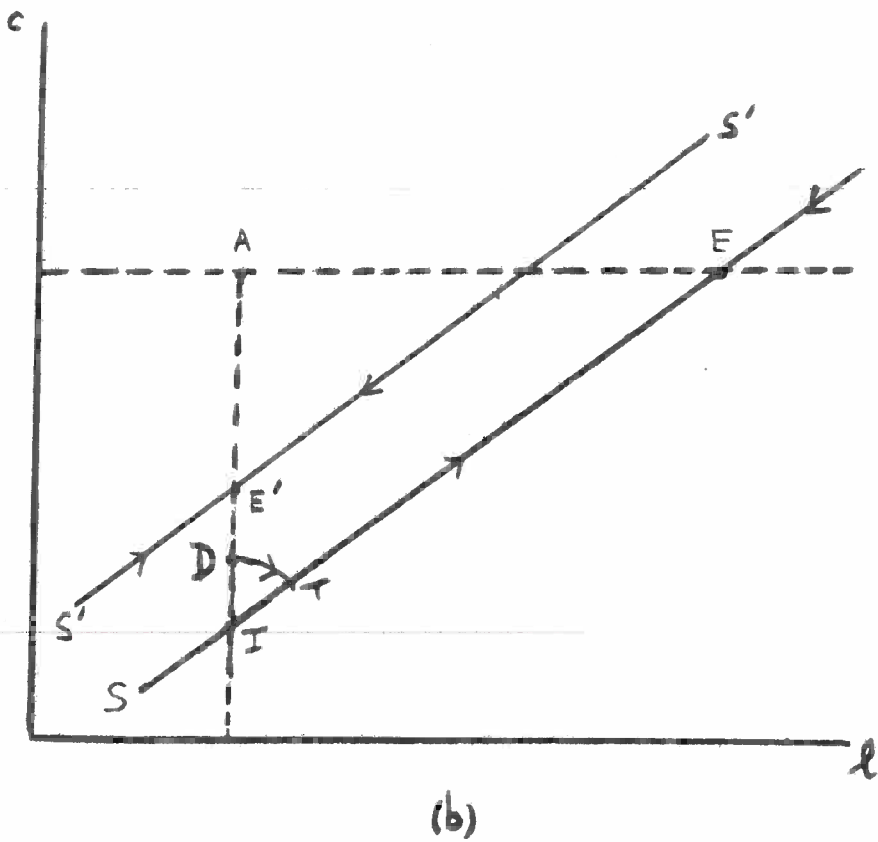
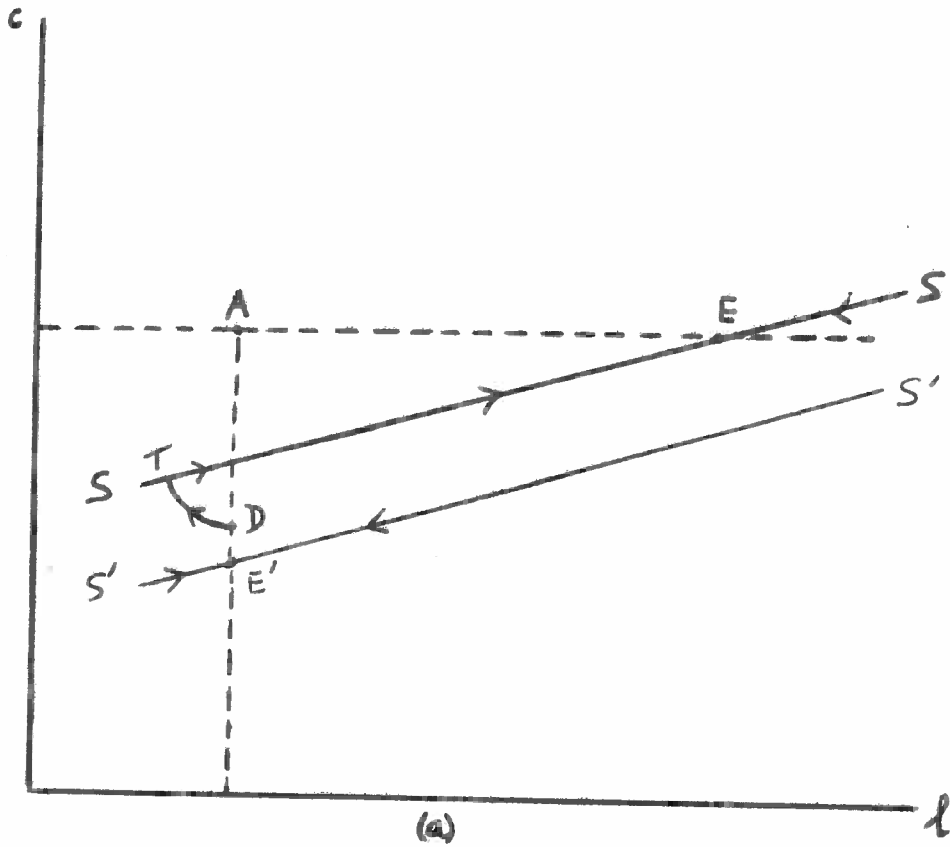

If core inflation adjusts slowly towards the new rate of monetary growth, rather than moving quickly after a fixed delay, then of course the appropriate dynamic equation should be added to the model (e.g. $D\bar{\pi} = \xi(\mu - \bar{\pi})$). Our analysis avoids adding another differential equation, but the size of the jump for the case of sluggish adjustment may be handled without difficulty by the methods described in Appendix 1.

The behaviour of output, interest rates and inflation

Before moving on to variants of the basic model described in this section, we show what happens to output, interest rates and inflation in response to the three principal policy actions described above, both on impact and over time. This is most easily done with reference to Figure 6. In the bottom panel is the augmented Phillips curve. Initial equilibrium is at point A', with output at its "high employment" level, y_h (where units are chosen so $y_h = 0$), and inflation equal to the rate of monetary growth, μ . The same equilibrium is shown at point A in the upper panel. As the IS curve is drawn with reference to the real rate of interest ($r - Dp$) on the right hand vertical axis while the LM curve is drawn with respect to the nominal rate on the left, equilibrium requires that the IS and LM schedules are vertically separated by the rate of inflation. This is achieved by "adding" the augmented Phillips curve vertically on top of the IS curve.^{1/} The resulting curve labelled ISPC is shown passing through point A. This schedule will slope down to the right if $\phi = 0$, but becomes horizontal when $\phi = 1/\gamma$, and slopes up as ϕ increases further. We assume that the ISPC curve does not slope up so steeply as to cut the LM curve from below. This condition

^{1/} Algebraically, this schedule is obtained by substituting the Phillips curve, equation (3) into the IS curve, equation (2); the coefficients are given in the bottom row of (6) above.

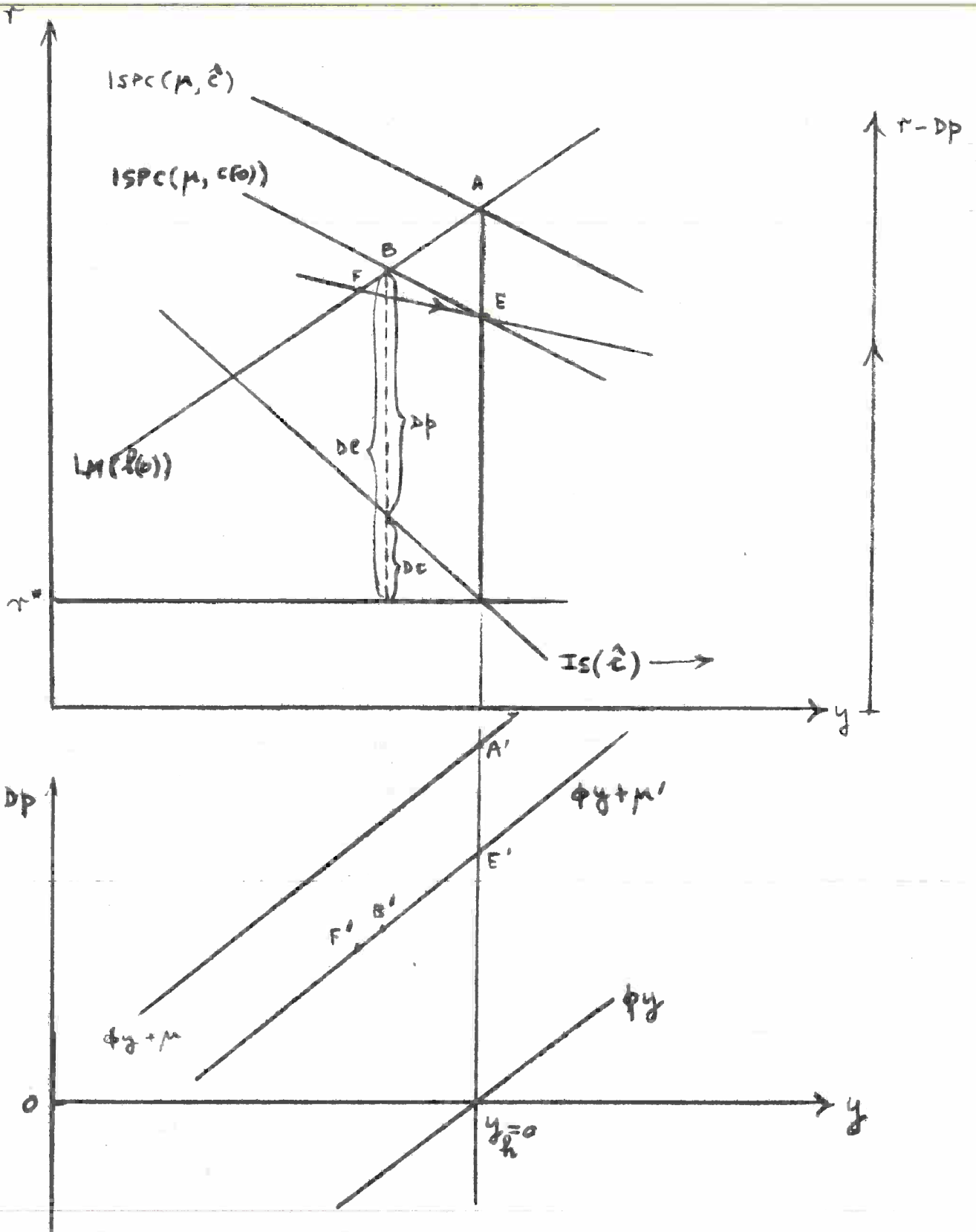

FIGURE 6 The behaviour of output, interest rates and inflation

$$\left(\frac{dr}{dy} \Big|_{LM} = \frac{k}{\lambda} > \frac{dr}{dy} \Big|_{ISPC} = \frac{\phi\gamma - 1}{\gamma} \right) \text{ is equivalent to the condition that}$$

$\Delta = \lambda(\phi\gamma - 1) - \gamma k < 0$. If it holds, an increase in effective demand increases output at a given nominal interest rate and a given level of competitiveness. The equilibrium then is a saddlepoint.

When the rate of monetary growth is reduced, the augmented Phillips curve shifts down in the bottom panel and so the ISPC schedule shifts down in the top panel. The intersection of this ISPC schedule with the high employment level of output, y_h , indicates the new level of equilibrium, E, where neither the real exchange rate nor output differ from what they were at A, but nominal interest rates have fallen by the amount of the monetary slowdown. It might be thought that B would describe the impact effect but this cannot in general be so. In the case represented in Figure 6, the distance from B to the world rate of interest must measure De and the distance from B to the IS curve measures inflation Dp , so the difference measures $De - Dp \equiv Dc$. Hence at all points to the left of E competitiveness will be improving - which is why the economy cannot start at B and proceed along ISPC to E.^{1/} Instead what happens, as has been discussed above, is a sharp initial fall in competitiveness which lowers both the IS curve and the ISPC curve so that the latter intersects the LM curve at a point such as F. This will represent the initial equilibrium for nominal interest rate and output, with the inflation rate shown by F' in the lower panel. Since the model is linear and, if stable, is driven by only one root, the system must proceed in a straight line^{2/} from F to E with increasing real money balances shifting the LM curve to the right and improving competitiveness shifting the IS and ISPC curves to the right. The derivation of this convergent path

^{1/} Unless there is a real interest equalisation tax in force, see IV below.

^{2/} This line is, of course, the stable locus corresponding to SS in the earlier figures.

in $r - y$ space is given in Appendix 2. The initial equilibrium, given by the interesection of the LM curve and the ISPC curve corresponding to μ' and $c(0)$, shows the nominal interest rate falling in response to the monetary disinflation. The initial level of the rate of interest can indeed lie beneath its long run equilibrium value if ϕ is large enough, so that the ISPC curve is flat or upward sloping; in this case the rapid fall of inflation causes a more serious recession with interest rates beneath their long run level given by E. What this possibility brings out is the very strong assumptions built into the Dornbusch-Liviatan model, namely that core inflation falls instantly in line with monetary growth and that output adjusts instantly to changes in interest rates and the real exchange rate.

The cases where the VAT rate is increased and where the own rate on money rises^{1/} (not shown) result in an initial contractionary shift in the LM curve, with no direct effect on the ISPC. Note that in this case the nominal interest rate will rise on impact if the ISPC curve is sufficiently downward-sloping. For reasons which have been discussed the currency appreciates and this lowers the ISPC to give the initial equilibrium at a lower level of income and nominal interest rates than in the initial equilibrium. In this case there is no immediate response of core inflation Π as there is no change in monetary growth. Only excess capacity lowers D_p .

The strong assumptions about the speed of clearing for the goods market and of the responsiveness of the "core" rate of inflation to monetary growth which characterise the Dornbusch-Liviatan model used here are by no means required to obtain the real exchange overshooting propositions of this paper. Relaxing them does however lead to a higher order differential equation system requiring numerical, rather than purely algebraic, analysis.

^{1/} Or where the level of the nominal money stock is reduced.

The impact of oil

While the preceding analysis has emphasised the impact of monetary policy actions on the level of competitiveness, there are some observers of the current scene who argue emphatically that, for the UK, a major factor affecting international competitiveness is the discovery and extraction of North Sea oil, see Forsyth and Kay [1980] for example. Hence, although we are principally concerned with monetary policy, we do briefly discuss the effect of discovering and exploiting a previously unknown endowment of natural resources in the context of our simple model. (as the following exposition is greatly simplified, the reader is referred to Buiter and Purvis [1980] for a more adequate treatment).

We distinguish between the value of current oil production (which is taken to be a fixed percentage, ρ , of the value of non-oil production, and to last for only a limited period) and the permanent income equivalent of this stream ρ_{∞} (i.e. that constant percentage of non-oil income which has the same present discounted value as the finite flow of oil). As can be seen from the structural equations (1) and (3) listed above, the value of current production ρ affects the demand for money (by $k\rho$ per cent), while the permanent income value of the oil is assumed to affect the demand for home-produced non-oil goods (whose high employment supply is taken to be unaffected). As is apparent from equation (2) the impact of this increase in demand for given r and y is to lead to an offsetting loss of competitiveness $dc = \frac{-X\rho_{\infty}}{\delta}$ which will reduce the demand for non-oil output to match the fixed supply. In Figure 7 this loss of competitiveness is shown by the fall of c from A to B, and, in the absence of the effect of current oil production on the LM curve, this would be the end of the story.

The effect of the temporary element, ρ , is rather like the effect of a temporary contraction of the nominal money supply: it reduces the amount of

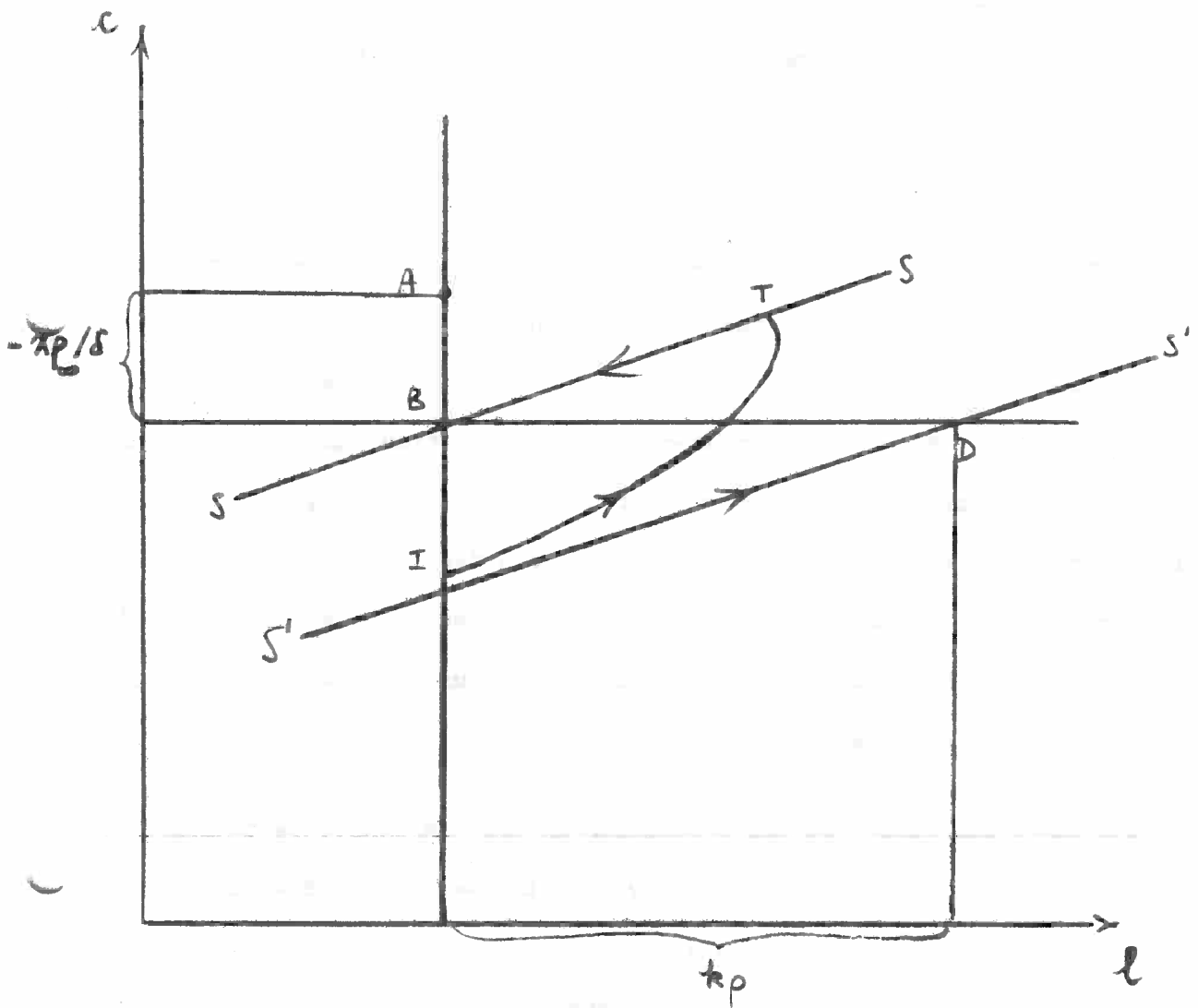

FIGURE 7 The impact of oil on liquidity and competitiveness

real balances left to "turn over" non-oil production. While oil is being produced therefore, the level of real balances required to maintain full-employment of labour will rise by kp , and this is shown by point D in Figure 7. The exchange rate will not move the system on to the path S'S' associated with point D, however, as the flow of oil is assumed to end after T periods. Instead the level of competitiveness will fall to point I; from which, after T periods, the system would reach the stable path SS, which will take it ultimately to point B, the long run equilibrium.

It may again be useful to see what is implied for the level of non-oil output and interest rates, and this is shown in Figure 8. The horizontal axis measures non-oil production as before, but the LM curve now depends on real balances net of the amount needed for oil production, and the IS curve depends on the permanent income derived from oil. Initial equilibrium is at point A.^{1/} The effect of this permanent income effect on the initial equilibrium is to change neither y nor r , but simply to change the labels on the IS and ISPC curve. The extra demand caused by p_{∞} will instantly be offset by the lower level of competitiveness.

The immediate effect of oil production on the LM curve is to shift it to the left (by kp). The system will not however move down to G on the stable locus SS^{2/} (which would lead directly back to the initial equilibrium at E) but to point I from where after T periods it will arrive at point T. At this time oil production will cease, so the LM curve will shift (by kp) and put the system at point T' from where it will approach A from the south east. (The locus labelled UU is that associated with the unstable eigen vector).

^{1/} This is also the new long-run equilibrium.

^{2/} This locus is derived in Appendix 2 together with the unstable locus UU.

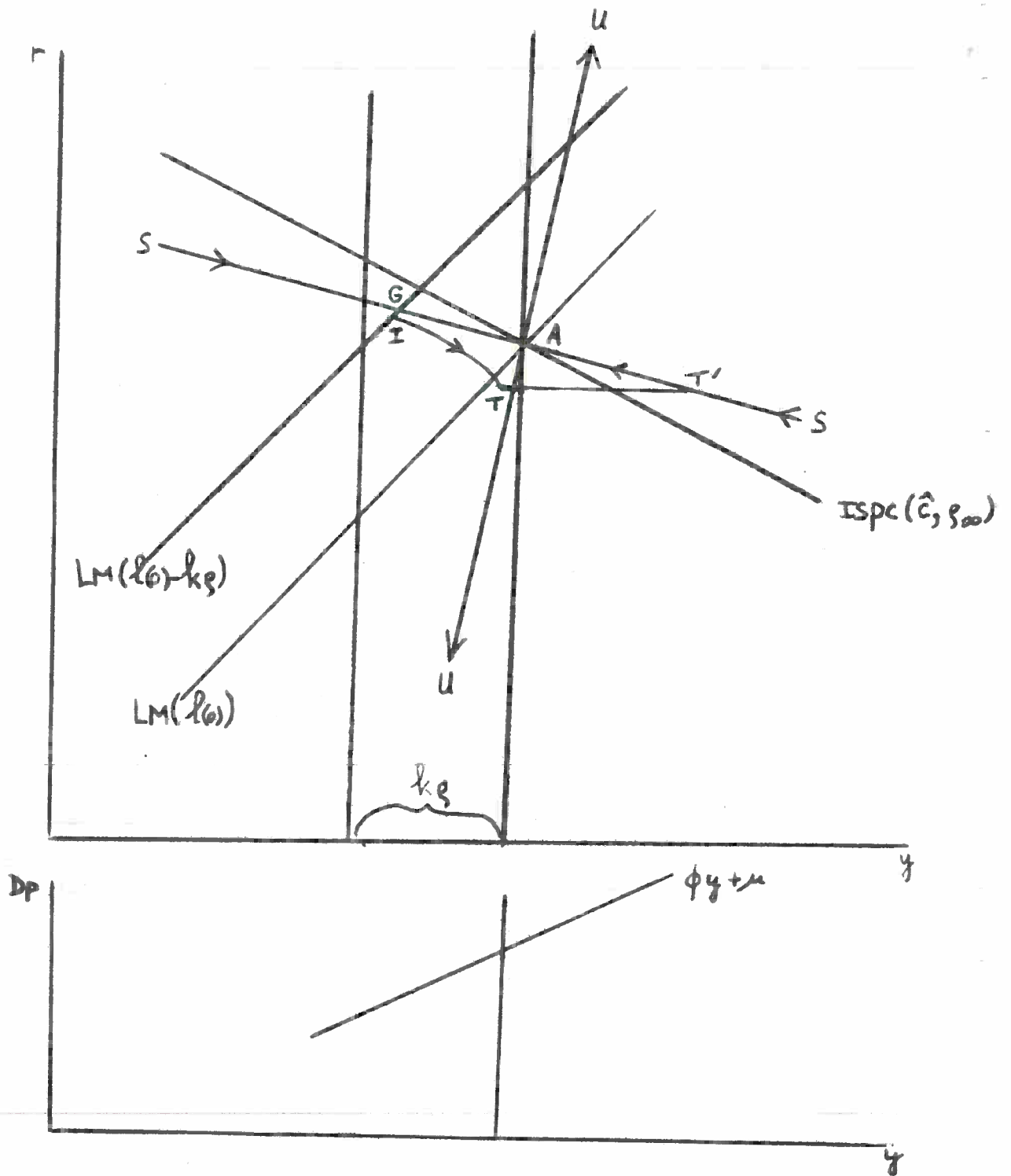

FIGURE 8 The impact of oil: output, interest rates and inflation

Once again, by looking directly at income and interest rates, we see how they will behave under the (implausible) assumptions that the goods market clears instantly and responds instantly to a change in competitiveness. ^{1/} Output declines on impact. The nominal interest rate will rise if the ISPC curve has a sufficiently negative slope. If ϕ is large so the ISPC curve is flat or slopes positively, interest rates fall.

^{1/} More precisely, that output responds instantly to demand and demand responds instantly to a change in competitiveness or in the real interest rate.

III. The consequences of limited capital mobility

In this Section we see what happens when capital is not perfectly mobile internationally. The interest parity condition of equation (5) is now replaced by a capital inflow equation:

$$(9) \quad DF = \frac{1}{\sigma} (r - r^* - De - \tau) \quad \sigma \geq 0$$

DF is the net inflow of capital, σ^{-1} the speed of response of capital flows to international interest rate differentials; so σ is a measure of the sluggishness of capital movements; perfect capital mobility exists when $\sigma = 0$, and zero capital mobility prevails as $\sigma \rightarrow +\infty$. The balance of payments equilibrium condition is given by (10)

$$(10) \quad \eta c - \nu y + DF = 0 \quad \eta, \nu > 0.$$

The current account surplus is given by $\eta c - \nu y$. Interest income from foreign ownership is omitted as are the consequences of asset accumulation or decumulation through current account surpluses or deficits. Satisfactory treatment of asset dynamics requires higher dimensional dynamic systems and numerical solutions

III.1. Limited but non-zero capital mobility

For simplicity all exogenous variables other than μ , r^* and τ are omitted in what follows. The rest of the model is therefore given by:^{1/}

$$(11) \quad \dot{k} = ky - \lambda r$$

$$(12) \quad y = -\gamma(r - Dp) + \delta c$$

$$(13) \quad Dp = \phi y + \mu .$$

^{1/} This is similar to the model of Frenkel and Rodriguez [1980].

The model of equations (9) - (13) can be solved as

$$(14) \begin{bmatrix} D\ell \\ Dc \end{bmatrix} = \frac{1}{\Delta} \begin{bmatrix} \phi\gamma & \phi\lambda\delta \\ 1+\nu\sigma\gamma & \delta(\phi\lambda-k+\lambda\nu\sigma)+\sigma\eta\Delta \end{bmatrix} \begin{bmatrix} \ell \\ c \end{bmatrix} + \frac{1}{\Delta} \begin{bmatrix} \phi\lambda\gamma & 0 & 0 \\ \lambda+\nu\gamma\lambda\sigma & -\Delta & -\Delta \end{bmatrix} \begin{bmatrix} \mu \\ r^* \\ \tau \end{bmatrix}$$

where as before, $\Delta = \gamma(\phi\lambda-k)-\lambda < 0$.

Comparing (14) with (7) and Table 1, it is clear that the perfect capital mobility model is indeed the special case of the model in (14) as $\sigma \rightarrow 0$.

Qualitatively, the behaviour of the system with limited capital mobility is not very different from the behaviour under perfect capital mobility.

The slope of the $D\ell = 0$ locus is independent of the degree of capital

mobility: $\left. \frac{dc}{d\ell} \right|_{D\ell=0} = -\frac{\gamma}{\delta\lambda} < 0$. The slope of the $Dc = 0$ locus does

depend on σ : $\left. \frac{dc}{d\ell} \right|_{Dc=0} = \frac{-(1+\nu\gamma\sigma)}{\delta(\phi\lambda-k+\lambda\nu\sigma)+\sigma\eta\Delta}$. For the long-run equilibrium

to be a saddlepoint a necessary and sufficient condition is that

$$(15) \frac{\delta + \gamma\eta\sigma}{\Delta} < 0$$

or $\delta + \gamma\eta\sigma > 0$ if $\Delta < 0$.

As in the case of perfect capital mobility, an upward-sloping $Dc = 0$ locus is sufficient to generate a saddlepoint equilibrium. If the $Dc = 0$ locus is downward-sloping a saddlepoint solution exists only if the $Dc = 0$ locus is steeper than the $D\ell = 0$ locus, again as before.

The magnitude of the initial jump in competitiveness depends on σ in a way that is in general ambiguous. For a given change in policy instruments or exogenous variables it depends a) on the change in the long-run equilibrium values of c and ℓ and b) on the slope of the stable path SS' . The

change in the long-run equilibrium is independent of the speed of adjustment of capital flows and the size of the jump in c therefore depends only on the slope of SS' . As we assume SS' to be upward-sloping, the magnitude of the jump increases with the degree of capital mobility if the slope of SS' increases. In Appendix 3 we apply the general method of Appendix 1 to our two equation dynamic model and derive the result that the slope of SS' is given by $\frac{x_{2s}}{x_{1s}}$ where x_{1s} and x_{2s} are the elements of the eigen-vector

corresponding to the stable eigen value ρ_s . That is:

$$(16) \quad c = v\ell = \frac{x_{2s}}{x_{1s}} \ell$$

This is illustrated in Figure 9.

We also show in Appendix 3 that, after normalization,

$$(17a) \quad x_{2s} = 1$$

and

$$(17b) \quad x_{1s} = \frac{\phi\lambda\delta\Delta^{-1}}{\rho_s - \phi\gamma\Delta^{-1}}$$

Therefore:

$$(18) \quad c = \left(\frac{\rho_s - \phi\gamma\Delta^{-1}}{\phi\lambda\delta\Delta^{-1}} \right) \ell$$

In (18) only ρ_s depends on σ . As $\phi\lambda\delta\Delta^{-1}$ is negative, V , the slope of SS' will increase when the degree of capital mobility increases if

$$\frac{\partial V}{\partial \sigma} < 0 \quad \text{or equivalently, if} \quad \frac{\partial \rho_s}{\partial \sigma} > 0.$$

Let ρ_u denote the unstable root and A the state transition matrix in (14).

We know that

Figure 9 The dependence of the initial jump in c on the degree of capital mobility.

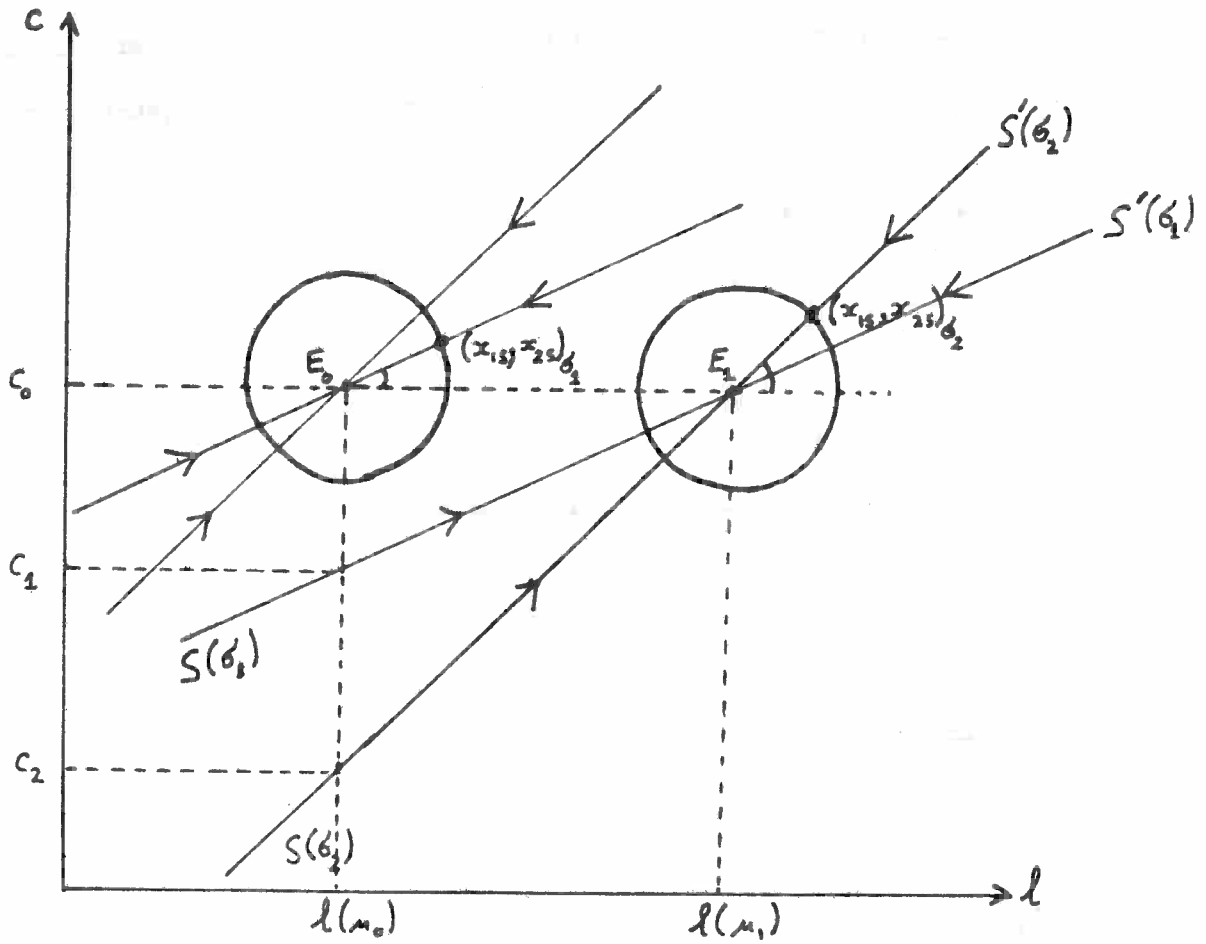

$$\begin{aligned} \sigma_2 &< \sigma_1 \\ \mu_1 &< \mu_0 \end{aligned}$$

$$(19) \text{ Det } A = \rho_u \rho_s$$

$$(20) \text{ Trace } A = \rho_u + \rho_s .$$

If the equilibrium is a saddlepoint Det A is negative. Trace A can be either negative or positive. (19) and (20) are graphed in Figure 10. Det A is a rectangular hyperbola DD in the NW quadrant while Trace A is a downward-sloping 45° line, TT .

Now

$$(21) \text{ Det } A = \frac{\delta + \gamma \eta \sigma}{\Delta}$$

and

$$(22) \text{ Trace } A = \frac{\phi \gamma + \delta (\phi \lambda - k + \lambda \nu \sigma) + \sigma \eta \Delta}{\Delta}$$

Therefore

$$(23) \frac{\partial \text{Det} A}{\partial \sigma} = \frac{\gamma \eta}{\Delta} < 0 .$$

The DD schedule shifts down and to the right when σ increases unless γ or η equal zero.

$$(24) \frac{\partial \text{Trace } A}{\partial \sigma} = \frac{\delta \lambda \nu}{\Delta} + \eta .$$

The shift of the TT schedule is ambiguous when σ increases.

However, when $\gamma = 0$ (i.e. absorption is completely interest inelastic and the IS curve is vertical), then

$$(25) \frac{\partial \text{Det } A}{\partial \sigma} = 0$$

and

$$(26) \frac{\partial \text{Trace } A}{\partial \sigma} = -\delta \nu + \eta .$$

Thus if $\gamma = 0$, the TT schedule shifts up and to the right when σ increases if $\eta > \delta \nu$, down and to the left if $\eta < \delta \nu$. Clearly,

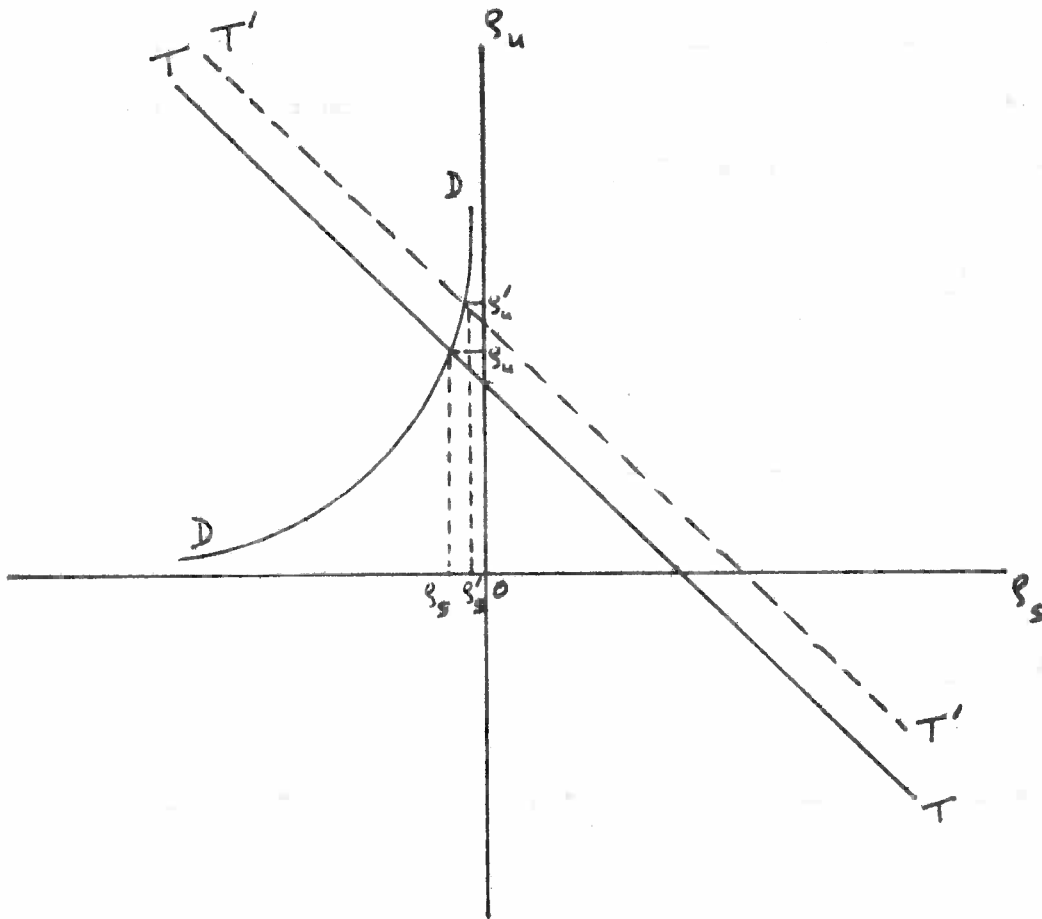

Figure 10 The effect of a reduction in the degree of capital mobility on the characteristic roots when $\gamma = 0$ and $\eta > \delta v$

ρ_s increases if, with DD fixed, TT shifts up to T'T', say. The initial jump appreciation of the exchange rate will therefore be larger when the degree of capital mobility increases (σ declines) if $\eta > \delta v$. The interpretation of this is as follows. Substitute for y in the balance of payments equilibrium condition (10) using (12). This yields, if $\gamma = 0$,

$$(27) (\eta - \delta v)c + DF = 0$$

If an improvement in competitiveness improves the current account after allowing for the expansionary effect on output of the improvement in competitiveness, $\eta - \delta v$ is positive. $\eta - \delta v > 0$ is also necessary and sufficient for an appreciation of the real exchange rate to be associated with an increase in the covered interest differential: $r - r^* - De - \tau = -\sigma(\eta - \delta v)c$. The scenario following an unanticipated reduction in μ is therefore as follows. r declines but $r - De$ increases. Output falls. The inflow of capital expands because $r - De - r^* - \tau$ is larger. The lower level of output would cet. par. improve the current account. On balance, however, the current account worsens because the incipient overall balance of payment surplus is prevented by a jump appreciation of the real exchange rate.

This set of sufficient conditions for an increase in the degree of capital mobility to increase the size of the jump in competitiveness -- low interest elasticity of aggregate demand and a positive net effect of competitiveness on the current account -- is empirically plausible. In the limit, as $\sigma \rightarrow \infty$ we approach the case of zero capital mobility. As shown in Section III.2, if capital is immobile and there is no effect of interest rates on effective demand, there is no response at all of competitiveness and output to changes in the rate of monetary growth. Such "current account monetarism" can therefore be seriously misleading when it comes to the effects of monetary policy on the real exchange rate.

III.2. Immobile capital or "current account monetarism" and the real exchange rate

Without any international mobility of financial capital, the mechanism through which a reduction in monetary growth affects real output and the real exchange rate changes significantly. The interest rate now clears a domestic bond market that is segmented from the rest of the world. The momentary equilibrium values of output, interest rate and exchange rate are determined by IS, LM and trade balance equilibrium. Financial autarchy may not be of great relevance to the U.K. economy, but the analysis of this case is nonetheless of interest because a significant amount of earlier monetarist analysis of the open economy seems to have been based, implicitly or explicitly, on a model similar to the "current account monetarist" models of this sub-section. ^{1/}

To analyse this case we set σ^{-1} , the degree of international capital mobility equal to 0 in (9). In order to aid our interpretation of earlier work in the spirit of this model we shall consider two alternative specifications of the "core" or trend inflation rate, Π , in the augmented Phillips curve, $Dp = \phi y + \Pi$. They are:

$$(28a) \quad \Pi = \mu$$

or

$$(28b) \quad D\Pi = \zeta(Dp - \Pi) \quad \zeta > 0$$

"Core" inflation is given either by the rate of monetary growth - the Dornbusch-Liviatan case^{2/} (D-L) - in (28a) or by a partial adjustment mechanism -

^{1/} See for example, Laidler (1975, Chapter 9), Friedman (Treasury and Civil Service Committee [1980, p. 61]).

^{2/} Neither Dornbusch nor Liviatan have to our knowledge applied their price equation to the study of "current account monetarism".

"Manchester monetarism" - in (28b). The latter specification imparts significantly more inertia to price behaviour: not only the price level but also the core rate of inflation are predetermined.

D-L current account monetarism

Using (28a) the model can be represented as in equations (29) - (32).

$$(29) \quad D\ell = -\phi\Omega\gamma\lambda^{-1}\ell - \phi\Omega\gamma\mu$$

$$(30) \quad \gamma = \Omega\gamma\lambda^{-1}\ell + \Omega\gamma\mu$$

$$(31) \quad c = v\Omega\gamma\eta^{-1}\lambda^{-1}\ell + v\Omega\gamma\eta^{-1}\mu$$

$$(32) \quad \Omega = [1 + \gamma(k\lambda^{-1} - \phi) - \delta v\eta^{-1}]^{-1}$$

$$= [-\lambda^{-1}\Delta - \delta v\eta^{-1}]^{-1}$$

The steady-state equilibrium is given by

$$(33a) \quad \hat{\ell} = -\lambda\mu$$

$$(33b) \quad \hat{c} = 0$$

The model will be stable if $\Omega > 0$. We shall assume this to be the case. The evolution of the real money stock and the real exchange rate is depicted in Figure 11. As before there is no long-run effect of a reduction in μ on the real exchange rate, but the steady state stock of real money balances increases. The impact effect of an unanticipated reduction in μ is an immediate appreciation of the real exchange rate from E_1 to E_{12} in Figure 11(b), unless $\gamma = 0$ in which case there is no effect. After this there is a gradual real depreciation towards the original value of c , at E_2 . Output also first declines and then increases back to the fixed full employment level. With ℓ given, the impact effect of a reduction in μ on r is to lower it:

(a)

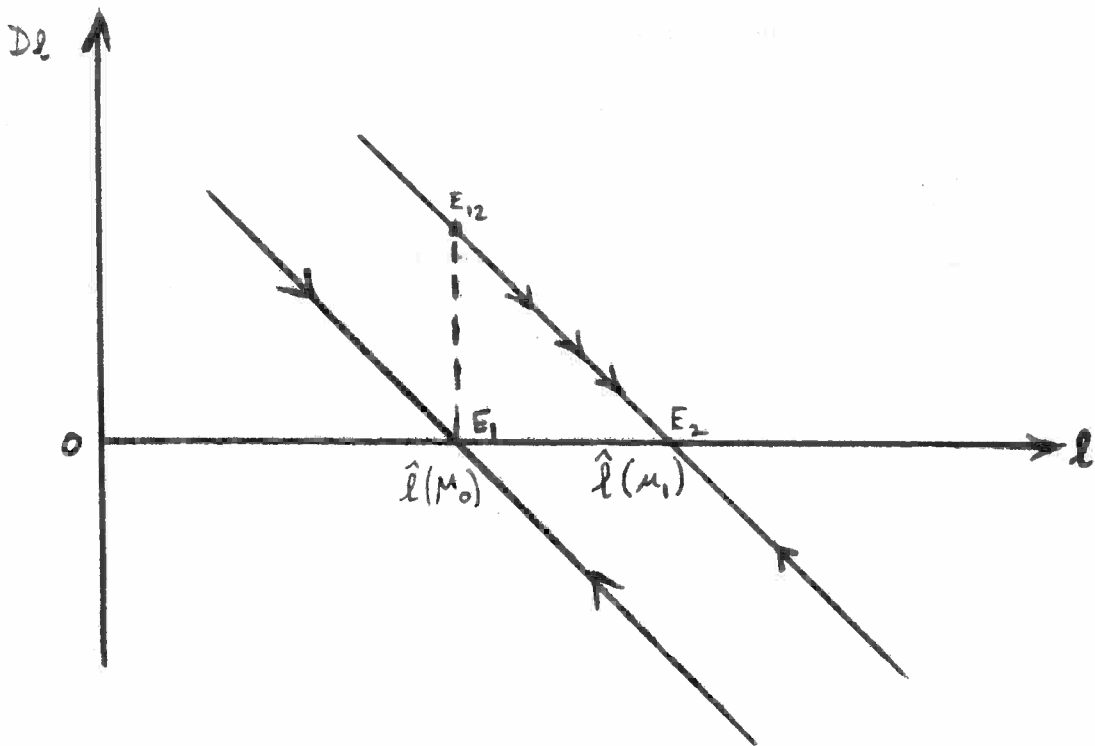

(b)

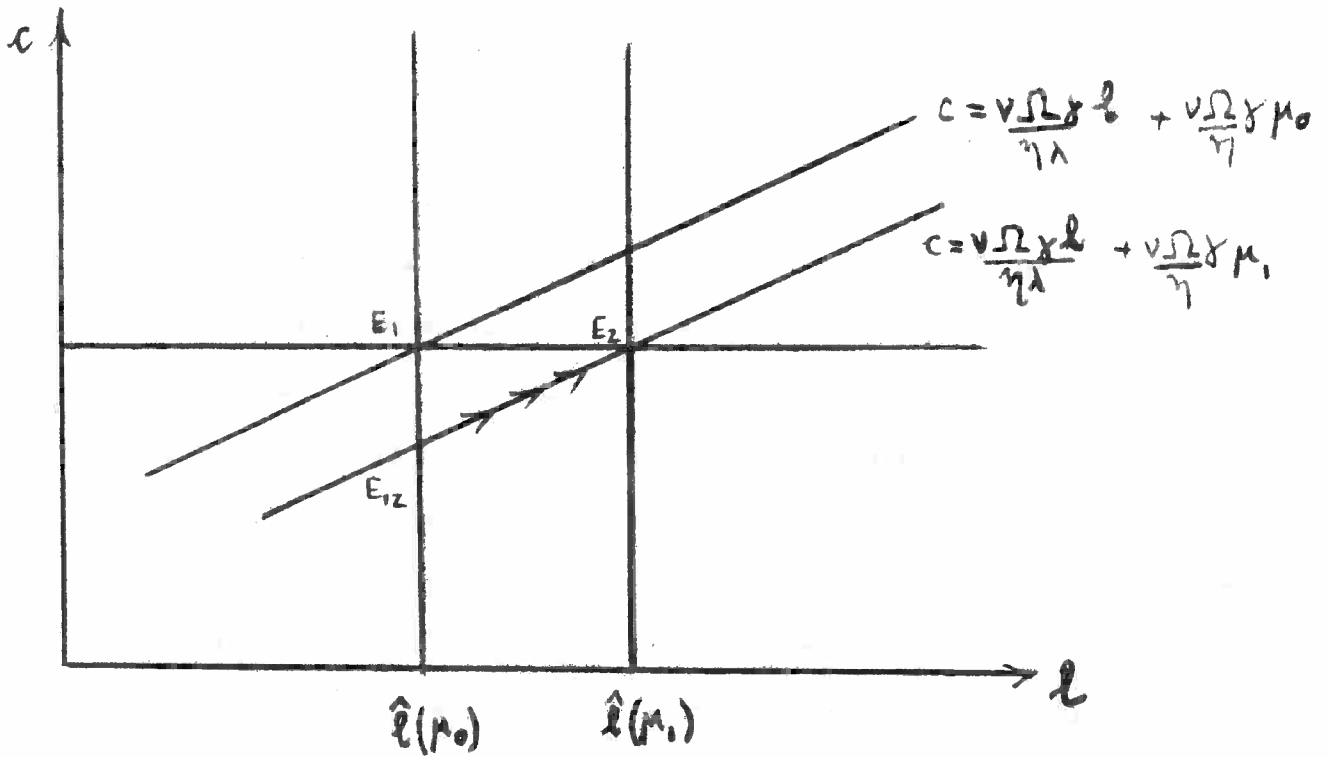

Figure 11 Current account monetarism with jumps in the rate of inflation. $\mu_1 < \mu_0$.

$r = k\Omega\gamma\lambda^{-1}\mu + \lambda^{-1}(k\Omega\gamma\lambda^{-1}-1)\ell$. The steady state real interest rate remains unchanged.^{1/} To maintain current account balance as real output declines the real exchange rate appreciates. While the transmission mechanism is quite different here from what it is under perfect or limited international capital mobility, the effects on y and c are qualitatively similar although in all probability quantitatively smaller. With the D-L specification of the "core" inflation rate, an unanticipated reduction in the rate of monetary growth initially leads to a decline in output and a "jump" fall in the real exchange rate followed by a gradual (monotonic) return to their original long-run equilibrium levels. Some exchange rate "overshooting" can occur even without capital mobility.

Jumps in the real exchange rate in response to monetary disinflation are ruled out in the Manchester version of current account monetarism (28b), however, as we shall see.

"Manchester" current account monetarism

With equation (28b) substituted for (28a), there is considerably more inertia in price behaviour. The rate of inflation no longer responds point for point (holding y constant) to a change in the rate of growth of the nominal money stock. There are two (predetermined) state variables : Π and ℓ .

^{1/} The impact effect on the real interest rate is ambiguous:

$$r - Dp = [\Omega\gamma(k\lambda^{-1} - \phi) - 1]\mu + \lambda^{-1}[\Omega\gamma(k\lambda^{-1} - \phi) - 1]\ell$$

$$= [\delta v\eta^{-1} - 1]\Omega\mu + \lambda^{-1}[\delta v\eta^{-1} - 1]\Omega\ell. \quad \text{If } \phi = k/\lambda, r - Dp = -\mu - \lambda^{-1}\ell$$

and reductions in μ lower the real interest rate point-for-point on impact.

The dynamic equations are given in (34).

$$(34) \begin{bmatrix} D \\ D\Pi \end{bmatrix} = \begin{bmatrix} -\phi\Omega\gamma\lambda^{-1} & -(\phi\Omega\gamma + 1) \\ \zeta\phi\Omega\gamma\lambda^{-1} & \zeta\phi\Omega\gamma \end{bmatrix} \begin{bmatrix} \ell \\ \Pi \end{bmatrix} + \begin{bmatrix} \mu \\ 0 \end{bmatrix}$$

Also:

$$(35) \quad y = \Omega\gamma\lambda^{-1}\ell + \Omega\gamma\Pi$$

and

$$(36) \quad c = v\Omega\gamma\eta^{-1}\lambda^{-1}\ell + v\Omega\gamma\eta^{-1}\Pi$$

Ω is as in (20) and is again assumed to be positive.

Long-run equilibrium is given by (33a) and (33b) with

$$\Pi = Dp = \mu.$$

Necessary and sufficient conditions for stability are

$$(37a) \quad \phi\Omega\gamma(\zeta - \lambda^{-1}) < 0$$

$$(38b) \quad \zeta\phi\Omega\gamma\lambda^{-1} > 0$$

The behaviour of the model is necessarily cyclical if it is stable, as in that case the discriminant of the characteristic equation is negative ($\phi\Omega\gamma[\phi\Omega\gamma(\zeta - \lambda^{-1}) - 4\zeta\lambda^{-1}] < 0$).

A stable cyclical adjustment path is drawn in Figure 12.

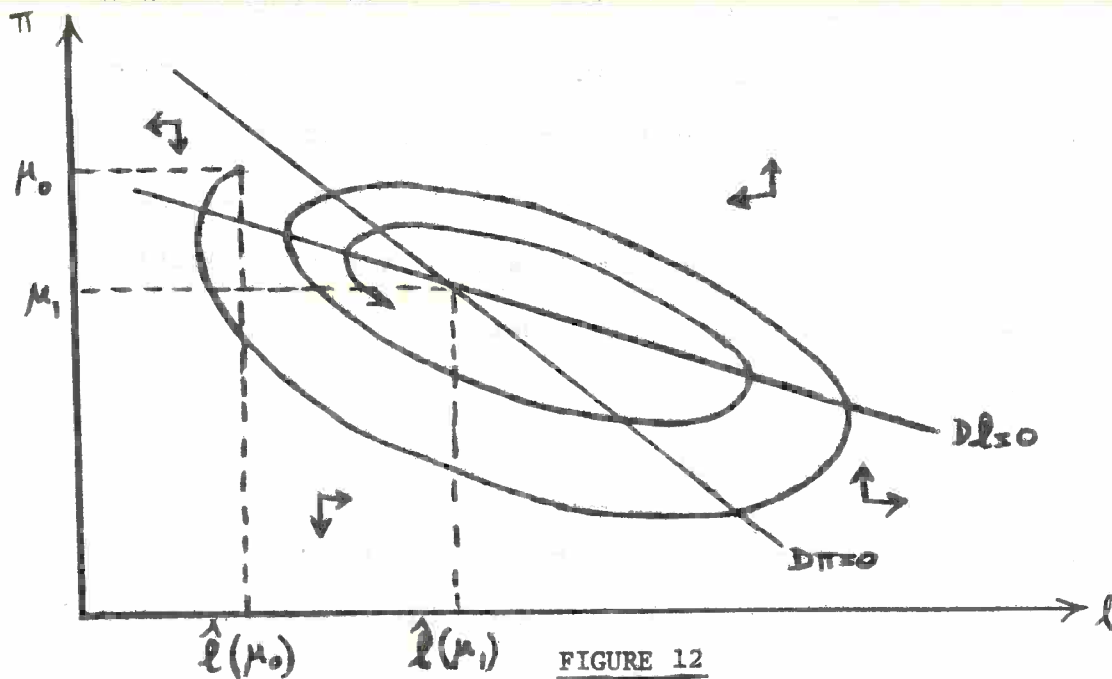

FIGURE 12

Current account monetarism with sluggish inflation.

From (36) it is apparent that changes in the rate of monetary growth do not lead to jumps in the real (or nominal) exchange rate : c is a function of ℓ and Π both of which are predetermined. The continuous adjustment path of c is given by:

$$(39) \quad Dc = r\Omega\gamma\eta^{-1}\phi\Omega\gamma\lambda^{-1}[\zeta-\lambda^{-1}]\ell + r\Omega\gamma\eta^{-1}[\phi\Omega\gamma(\zeta-\lambda^{-1})-\lambda^{-1}]\Pi$$

With both ℓ and Π behaving cyclically, c is also likely to exhibit cyclical behaviour, even though in principle the cyclical trajectories of ℓ and Π could neutralise each other as regards their influence on c . explicit numerical solutions are required to obtain the exact trajectory c in this case.

Omitting the capital account and attributing significant inertia to both p and Π - as is characteristic of Manchester monetarism - rules

out the possibility of the dramatic appreciation of the real exchange rate in response to a reduction in monetary growth that has characterised recent U.K. experience. However, because of the cyclical nature of the dynamic adjustment path, the maximal extent of overshooting of the long-run equilibrium on the solution trajectory may well be significant if $\gamma \neq 0$ and could even exceed the jump overshooting of our earlier models.

IV. A real interest rate equalization tax

One proposal for eliminating jumps in the real exchange rate due to monetary disinflation or other internal or external disturbances involves a real interest equalization tax. Liviatan [1980] has suggested a tax on capital inflows (subsidy on outflows) that will exactly achieve the aim of keeping international competitiveness constant. Consider the dynamic reduced form for ℓ and c given in equation (7). Ignoring all exogenous and policy variables other than τ , the tax on capital inflows, we have

$$(40) \quad Dc = \Delta^{-1} \ell + \Delta^{-1} \delta (\phi \lambda - k) c - \tau$$

The value of τ that sets $Dc = 0$ is given by:

$$(41) \quad \tau = \Delta^{-1} [\ell + \delta (\phi \lambda - k) c]$$

Since c is now a constant we can, without loss of generality, set it equal to zero and thus obtain

$$(42) \quad \tau = \Delta^{-1} \ell$$

Again ignoring exogenous and policy variables we can solve (1), (2) and (3) for y as follows:

$$(43) \quad y = -\Delta^{-1} [\gamma \ell + \delta \lambda c]$$

With $c = 0$ by choice of units we can rewrite (42) as

$$(44) \quad \tau = -\frac{1}{Y} y$$

This is Liviatan's result that to stabilise the real exchange rate, the capital import tax should be proportional to the deviation of actual output from high employment output. Note that since this tax achieves $De = Dp$, it follows that

$$(45) \quad r - Dp = r^* + \tau \frac{1}{Y}$$

Referring back to Fig. 6 we observe that the tax τ is designed so as to fill the gap between the IS curve, which shows the domestic real interest rate at the equilibrium level of competitiveness, and the world real interest rate r^* . While it prevents any loss of competitiveness, the tax does not prevent a contraction of income after a monetary slowdown. Thus in Figure 6 income contracts immediately to point B from which it proceeds gradually towards E along the ISPC schedule. (We show later that appropriate monetary action can offset both the income and real exchange rate consequences of a monetary slowdown).

A tax on capital inflows that perfectly stabilizes the real exchange rate also equalizes the real after tax rates of interest at home and abroad. It is this sort of tax which Dornbusch recommended for the U.K. in his evidence to the Treasury Committee cited above.

$$\frac{1}{Y} \quad \dot{r} = r^* + De + \tau \text{ implies } r - Dp = r^* + De - Dp + \tau .$$

The size of the initial loss of competitiveness

To illustrate how large the jump in the exchange rate might be relative to the extent of the monetary slowdown, we include some illustrative calculations for the equations used in Section II.

The factors affecting the size of the jump are best explained with reference to Figure 13. With time measured along the horizontal axis, the paths followed by the money stock, the price level and the exchange rate (the price of foreign currency) can, by appropriate choice of units, be represented by the single line AB until time t_0 when an unanticipated slowdown occurs (where for convenience $t_0 = 0$). The subsequent path is BC. In long run equilibrium the level of real balances must rise by $-\lambda d\mu$, as discussed in Section II, so the price level must approach the path labelled FE which lies the appropriate distance beneath BC. Under the assumptions that the derivative of prices responds instantly to the monetary slowdown, but the price level is slow to adjust, the price level will approach BC from above as shown by the path BG in the figure.

As the model is super neutral, the equilibrium real exchange rate will be unaffected by the change in the rate of monetary growth; so the exchange rate must also approach the path FE. Indeed, one can think of the line FE as defining a path for the "equilibrium" exchange rate, \hat{e} , as follows. The slope of FE (which is equal to μ) corresponds to the difference between the trend rate of inflation domestically (μ) and the trend rate of inflation overseas (assumed to be zero), and so measures the trend rate of change of the exchange rate; the level of FE is, as we have seen, such as to generate the correct real exchange rate in the long run.

Whether the actual exchange rate will, on the implementation of the slowdown, attain this path immediately or not is related to whether or not the domestic interest rate moves immediately to its new equilibrium level, as

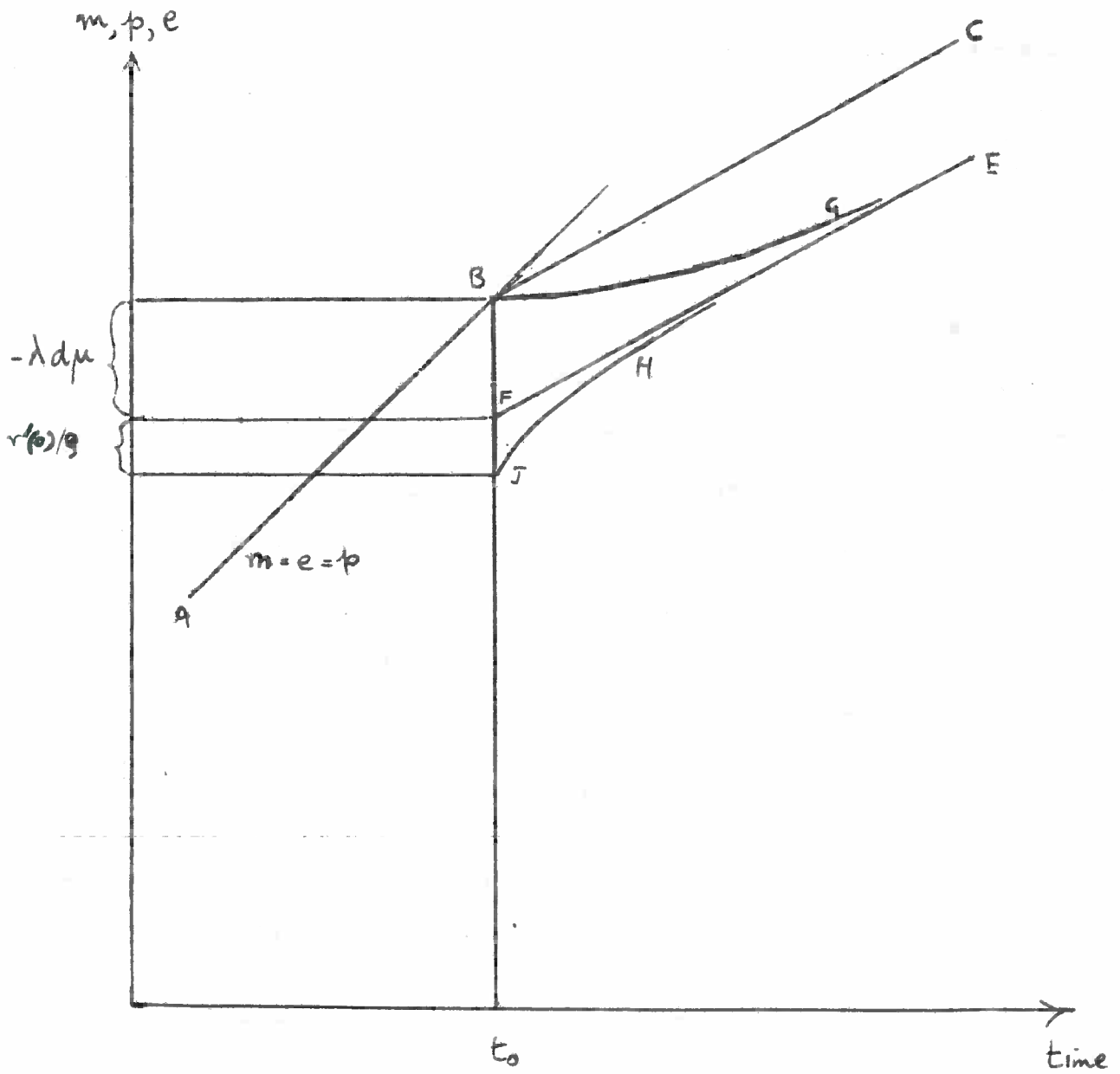

Figure 13. The consequences of a monetary slowdown and the determinants of the initial loss of competitiveness.

we shall show using the equation relating the rate of change in the price of foreign currency to the interest differential ($\dot{e} = r - r^* - \tau$) and the definition of \hat{e} which implied ($\dot{\hat{e}} = \mu$). We see that the price of foreign currency moves relative to its equilibrium path according to $\dot{e} - \dot{\hat{e}} = r - r^* - \mu$. The assumption that the exchange rate is a forward looking variable can be expressed by showing the relationship between the initial disequilibrium and expected future interest rate "disequilibria", as follows:

$$e(0) - \hat{e}(0) = -\int_0^{\infty} [r(s) - (r^* + \mu)] ds = -\int_0^{\infty} [r(s) - \hat{r}] ds = -\int_0^{\infty} r'(s) ds$$

where \hat{r} defines the equilibrium domestic interest rate, and r' is the discrepancy between the current value and this equilibrium value. So the initial level of the exchange rate, relative to the point F in the figure, depends on the integral of future values of r' , with the price of foreign currency lying below F if r' tends to be positive, and standing above F if the opposite is true. Since, in our simple model, all variables typically move along paths determined by one root, this integral is easily found and so we have

$$e(0) - \hat{e}(0) = -\int_0^{\infty} r'(s) ds = -\int_0^{\infty} r'(0) e^{-\rho s} ds = -r'(0)/\rho$$

where ρ denotes the absolute value of the stable root, and $1/\rho$ gives the mean lag of adjustment characterising all variables in the model.

The initial value of the real exchange rate can thus be expressed as

$$c(0) = e(0) - p(0) = e(0) - \hat{e}(0) + \hat{e}(0) - p(0) = -r'(0)/\rho + \lambda \mu .$$

The path followed by the exchange rate will approach FE from below if $r'(0)$ is initially positive, and such a case is shown in Figure 13, where the distance FJ corresponds to $r'(0)/\rho$.

To obtain some orders of magnitude we choose "plausible" parameter values as follows. The crucial parameter λ , the semi-elasticity of the demand for money, is set equal to 2, which is broadly consistent with the results reported by Graham Hacche in the study cited above. We assume that the income elasticity of demand for money is unity ($k = 1$) and that inflation falls, ceteris paribus, by $\frac{1}{2}$ a percentage point for each one per cent reduction in output ($\phi = \frac{1}{2}$). In addition we assume that both δ and $\gamma = \frac{1}{2}$; the former measures the elasticity of aggregate demand for domestic output with respect to the real exchange rate, and γ is the semi-elasticity of demand with respect to the real interest rate (so if the real interest rate is only about 0.05, this means a real interest rate elasticity only $\frac{1}{20}$ as large as the real exchange rate elasticity).

From an initial position of equilibrium, a 1% slowdown in monetary growth leads to an initial loss of competitiveness of about $2\frac{1}{3}\%$ with these parameter values.^{1/} This can be broken down into the 2% loss due to the fall in the "equilibrium" exchange rate ($\lambda d\mu$) and an additional 0.3% to 0.4% due to the fact that interest rates do not immediately fall by 1% to their new long run level. (The stable root is -0.42 and the initial level of interest

^{1/} From (18), we have

$$c'(0) \cong c(0) - \hat{c} = \left(\frac{\rho_s - \phi\gamma\Delta^{-1}}{\phi\lambda\delta\Delta^{-1}} \right) l'(0) - \left(\frac{\rho_s - \phi\gamma\Delta^{-1}}{\phi\lambda\delta\Delta^{-1}} \right) \lambda d\mu$$

$\rho_s = - .4215$ and $d\mu = - 1$. Therefore $c'(0) = - 2.36$.

rates is calculated as about $\frac{1}{6}$ of a point above equilibrium, so the integral $-r'(0)/\rho$ is (approximately) 0.33%.

Not only is an initial loss of competitiveness of about $2\frac{1}{3}\%$ to be expected from an (unanticipated) 1% monetary slowdown but according to the analysis in Section II, the same $2\frac{1}{3}\%$ loss of competitiveness is to be expected from a 1 percentage point increase in the rate paid on money (r_d), and from a 2 point increase in the general rate of indirect taxation (θ). We can thus estimate, very roughly, the impact to be expected in our model from the sort of monetary actions which have been taken in the U.K. in the last year or so on the level of competitiveness. An (unanticipated) 1% point monetary slowdown, plus a 2% point rise in r_d , and a 4% rise in the general rate of indirect tax would give a total loss of competitiveness of $5 \times 2\frac{1}{3} = 11\frac{2}{3}\%$. The recent loss of competitiveness in Britain has been much greater than this, exceeding 30% for manufacturing; but the calculation we have performed is biased downwards in at least two ways, which we now discuss.

We have so far assumed that the trend rate of inflation (π) responds immediately to the announcement of the monetary slowdown, which is undoubtedly over-optimistic. We can at least allow for some delay in the response of trend inflation to the monetary slowdown. If we assume an infinite delay, then for the above parameter there will be an immediate 4% loss of competitiveness as the economy moves into a recession with output falling by 2%. (This equilibrium corresponds to that shown by the point E' in Figure 5 in Section II.) For a delay of 2 years between the reduction in monetary growth and the response in core inflation, the initial loss of competitiveness turns out to be 3.1%, and for a 1 year delay it falls to 2.8%. So a delay of a year or so could add half a point to the loss of competitiveness to be associated with 1% slower monetary growth.

In calculating the impact of the monetary slowdown above, we ignored the present impact of actions announced for future years as in the Medium Term Financial Strategy. Instead of calculating a precise figure corresponding to the effect of a (credible) policy of 4 successive 1 point reductions in monetary growth spread over 4 years, we simply examine the effects of a policy of smooth monetary deceleration (as described by the formula $D\mu = -a\mu$). If the initial rate of monetary growth is 10% p.a. and a is equal to 0.173, then this implies cutting monetary growth to 5% in 4 years; if a is reduced to 0.139 then the half life of the monetary slowdown rises to 5 years. Either of these seems to be a reasonable description of the general policy adopted, one of initiating a monetary slowdown designed to eliminate inflation, with a half life of about 4 or 5 years. Using the same parameters as before we find that the implication of such a programme is to reduce competitiveness initially by around 8% points (7.5% for the 5 year half life, 8.7% for the 4 year case).

This calculation suggests that the current effect of policy announced for future years may be considerable. Of course such announcements may not be wholly credible, and so they may not get their full effects on impact (as we have discussed in Section III). If the authorities nevertheless pursue them vigorously, their credibility will doubtless increase over time, so the "impact effect" will get spread over time.

While it is not our present purpose to produce accurate point estimates of the impact of monetary policy actions on the real exchange rate, we believe that the illustrative calculations reported here lend support to the view that monetary policy actions have made a significant contribution to the alarming loss of international competitiveness recently experienced in the U.K. (Others have concluded likewise: in a recent paper Krugman (1980), for example, argued

that a one point monetary slowdown alone might lead to a 5 point loss of competitiveness. This is on the basis of output being constant and prices continuing completely unaffected for two years, before jumping immediately to their long run equilibrium.) Further light may be shed on this by examining more adequate dynamic models* and by empirical investigations which explicitly recognise the forward-looking nature of the exchange rate.

* allowing for lags of adjustment in the response of income to the real exchange rate and real interest rates, for example.

Conclusions

By attributing rational, forward-looking expectations to private agents one can analyse the current consequences of anticipated and unanticipated current and future policy changes and exogenous shocks. We have examined some aspects of the Medium Term Financial Strategy and of oil and V.A.T. shocks from this point of view. If foreign exchange speculators are forward-looking in a world with high capital mobility and a flexible exchange rate but a sticky domestic price level, then competitiveness is the first casualty in the fight against inflation.

Jumps in the real exchange rate would not occur if prices were perfectly flexible, however; because with an "efficient" market for goods complementing an efficient foreign exchange market, a "superneutral" real economy is unaffected by monetary actions, even in the short run. This postulate of perfect nominal wage and price flexibility, which we reject, is adopted by others both for theoretical analysis and for policy prescription; thus Patrick Minford, in a small econometric model fitted to annual data for the U.K., has money wages and prices responding immediately and fully to perceived monetary shocks (see his evidence to the Treasury and Civil Service Committee [1980, pp. 131-143] and the references given there).

One way in which jumps in the real exchange rate can be avoided is by imposing a real interest-equalization tax. While precisely such a tax has not, to our knowledge, been implemented anywhere, it is interesting to note that two tight-money, market-oriented economies (W. Germany and Switzerland) have made use of taxes on capital inflows in attempts to check their overvaluation.

Real exchange rate overshooting and departures of output from its full employment level are, in the model used in this paper, due to the inability of the real money stock to respond promptly to changes in demand for liquidity. This reflects stickiness of both the domestic price level and of the

level of the nominal money stock. Even if the inertia in the wage-price mechanism is taken to be an unalterable institutional constraint, changes in the real stock of money balances can be implemented immediately and without need for departures from full employment, by making the level of the nominal money stock respond to changes in the demand for real money balances without further need for change in the level of the path of the sticky domestic price level. For any policy change or exogenous shock, the required equilibrium change in the real money supply can be calculated from the steady-state conditions (see equation (8) and Table 2). If the level of the domestic price path is to remain unchanged, the required proportional change in the nominal money stock simply equals the required percentage change in real money balances. The paths of m , p and e when there is an unanticipated reduction in μ and time t_0 and an unanticipated increase in m (with $dm = -\lambda d\mu$) are shown in Figure 14.

As a topical example of how the real exchange rate can be stabilized by an appropriate jump in the nominal money stock, consider the policy of reducing the rate of growth of money to reduce the rate of inflation. Since this increases the steady state demand for real money balances, transitory real exchange rate appreciation and loss of output can be avoided by immediately increasing the level of the nominal money stock (by $-\lambda d\mu$) at the same time that the rate of monetary growth planned for the future is reduced. If one has adopted monetary targets and does not wish to be forced into a U-turn because of the effects on the real exchange rate, the appropriate policy is an M-jump!

The obstacles to such an accommodating monetary policy include both uncertainty about the model and credibility of such a combination of policy actions. The calculation of the nominal money supply change required to achieve the new long-run equilibrium corresponding to the new values of the policy instruments or exogenous variables immediately and without departures from full employment only appears simple because both policy makers and private agents in our model have full knowledge of the structure of the economy and the

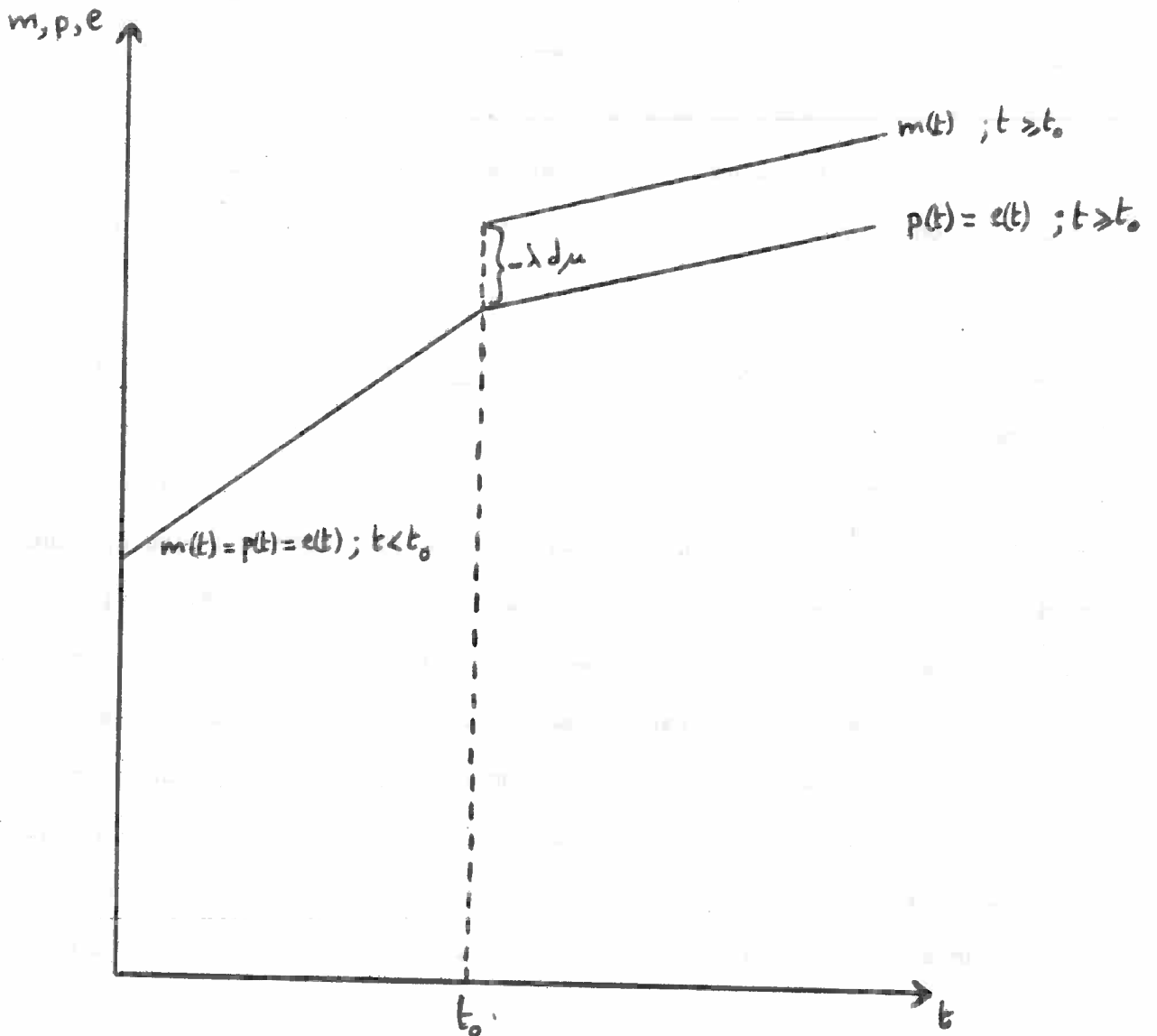

Figure 14 The effect of an unanticipated reduction in μ at t_0 accompanied by a real exchange rate and output stabilizing increase in m .

behaviour of the exogenous variables.

The policy credibility problem is obvious from our conclusion that in order to avoid exchange rate overshooting and excess capacity when the announced future rate of growth of the money supply is cut in order to reduce inflation, it is necessary to once-and-for-all increase the level of the nominal money stock. The intentions of the government are likely to be in doubt when a policy of monetary disinflation is initiated with an expansion of the nominal nominal money stock!

Not only do changes in the monetary growth rate require adjustments in the targeted path for the money stock if real exchange rate changes are to be avoided; so too do variations in the rate of indirect tax and changes in the demand for bank deposits arising from varying the regulations governing bank behaviour. Since there have been policy actions on all three fronts in 1979-1980 it will be interesting to see whether the authorities will choose to accommodate the resulting increased demand for real balances, or whether they will choose to stick to the path for the nominal money stock announced in the 1979 Budget. A policy of "rebasing" the monetary aggregates to grow as targeted before but from the higher level that has been reached after the rapid expansion over the summer would be a convenient way of avoiding the costs of deflation which would be required to stay within the previously announced target range.

Appendix 1

On determining the initial conditions for forward looking variables

The system described in the text allows the exchange rate to respond immediately and with discrete jumps to new information about the future, but the price level is unable to make such jumps, so its current level is determined by past history. Thus competitiveness (the "real" exchange rate, $e-p$) is free to respond to future events but liquidity (real balances, $m-p$) is determined by past history and the present money stock; and, as is evident from the phase diagrams in Figure 1, the interesting case is when there are two real roots to this system, one positive (unstable), one negative (stable). The initial value of competitiveness $\frac{1}{\dots}$ was obtained by considering only that path associated with the stable root, and also by using the initial condition $\frac{1}{\dots}$ for liquidity.

This method of solving for the initial values of the forward-looking variables is not restricted to two dimensions. Let there be an n -dimensional dynamic system with j forward looking variables. Assume there are j unstable roots, and $n-j$ stable roots. The eigen-vectors associated with these $n-j$ stable roots will (if they are distinct) span an $n-j$ dimensional subspace. Initial conditions for the $n-j$ predetermined variables will determine the initial conditions for the forward looking variables by the requirement that they lie on the stable manifold. (Thus if there were three variables

$\frac{1}{\dots}$ Expressed as a deviation from the long run equilibrium corresponding to the latest available information.

with one free to jump, the locus of stable solutions spanned by the eigenvectors associated with the stable roots will, unless the system is completely unstable, be a plane - with convergent paths "inscribed" on it. The initial conditions would determine a line and the intersection of the line with the plane would be where the forward-looking variable jumps to.)

Avinash Dixit has shown how the initial conditions may be determined algebraically as follows. Let the dynamic system be represented by

$$\begin{bmatrix} D\ell' \\ Dc' \end{bmatrix} = A \begin{bmatrix} \ell' \\ c' \end{bmatrix}$$

where ℓ' is a vector of $n-j$ historically determined variables

c' is a vector of j forward looking, jump variables

(and there are assumed to be no more than j unstable roots).

Diagonalising the matrix A yields

$$\begin{bmatrix} D\ell' \\ Dc' \end{bmatrix} = B \Lambda B^{-1} \begin{bmatrix} \ell' \\ c' \end{bmatrix}$$

where Λ is a diagonal matrix whose diagonal elements are the eigen-values of A , and $B\Lambda = AB$ by definition, so the columns of B are the right eigenvectors which can be arranged into two sets, the first $n-j$ eigen-vectors being those associated with the stable roots, and the others being associated with the unstable roots

i.e. $B = \begin{bmatrix} B_{11} & \vdots & B_{12} \\ B_{21} & \vdots & B_{22} \end{bmatrix}$ where $\begin{bmatrix} B_{11} \\ B_{21} \end{bmatrix}$ is the first set.

n-j columns j columns

The matrix B can be used to define n new variables as follows

$$\begin{bmatrix} s \\ u \end{bmatrix} = B^{-1} \begin{bmatrix} \ell' \\ c' \end{bmatrix} \quad \text{so} \quad \begin{bmatrix} Ds \\ Du \end{bmatrix} = \begin{bmatrix} \Lambda_1 & \\ & \Lambda_2 \end{bmatrix} \begin{bmatrix} s \\ u \end{bmatrix} \quad \left(\begin{array}{l} \Lambda_1 \text{ stable roots} \\ \Lambda_2 \text{ unstable roots} \end{array} \right)$$

where s are $n-j$ variables, converging to zero according to one stable root each, while the u variables would each diverge as each depends on an unstable root.

In order to ensure that $\begin{bmatrix} \ell' \\ c' \end{bmatrix}$ do not diverge over time, one needs to choose

the initial value $c'(0)$ so as to ensure that $u(0) = 0$ as

$$\begin{bmatrix} \ell' \\ c' \end{bmatrix} = B \begin{bmatrix} s \\ u \end{bmatrix} = \begin{bmatrix} B_{11} & B_{12} \\ B_{21} & B_{22} \end{bmatrix} \begin{bmatrix} s \\ u \end{bmatrix}$$

But writing out the requisite initial conditions explicitly yields

$$\ell'(0) = B_{11} s(0) + B_{12} u(0) = B_{11} s(0) \quad \text{if } u(0) = 0$$

$$c'(0) = B_{21} s(0) + B_{22} u(0) = B_{21} s(0) \quad \text{if } u(0) = 0$$

so one finds

$$c'(0) = B_{21} B_{11}^{-1} \ell'(0)$$

This is the general result, applied in the text to the simple two model case where it becomes $c'(0) = \frac{b_{21}}{b_{11}} \ell'(0)$, where c' and ℓ' are scalars.

In general, therefore, the initial conditions for the jump variables, chosen so as to achieve stability, in a linear system with unstable roots can be found by manipulating the eigen-vectors associated with the stable roots, together with the initial disequilibrium values for the historically predetermined variables, as shown in the formula. Of course, if the system is inherently unstable, with more unstable roots than jump variables, then there will be no jump that can put the system on a stable path. If the system has more stable roots than predetermined variables, then the transversality condition that the system converges to the long-run equilibrium is no longer sufficient to determine a unique set of initial values for the jump variables. There now is a continuum of initial conditions that is consistent with convergence. Additional restrictions have to be imposed to select a unique set of initial values.

Appendix 2

Output and interest rate dynamics

In the main text we have chosen to express the dynamics of adjustment in terms of competitiveness and liquidity. To study the implications of monetary shocks for output and interest rates it is convenient to express the dynamic equations in terms of the variables y and r which we do briefly below.

Instead of using the last two equations of equation y and r , one can instead differentiate them with respect to time and use the first two equations to eliminate c and l , which yields:

$$\begin{bmatrix} Dy \\ Dr \end{bmatrix} = \frac{1}{\Delta} \begin{bmatrix} \phi\gamma + \phi\lambda\delta & -\lambda\delta \\ \phi(1 - \gamma\phi) + \phi k\delta & -k\delta \end{bmatrix} \begin{bmatrix} y \\ r \end{bmatrix} + \frac{\delta}{\Delta} \begin{bmatrix} \lambda & \lambda & \lambda \\ k & k & k \end{bmatrix} \begin{bmatrix} \mu \\ r \\ \tau \end{bmatrix}$$

with the long-run equilibria defined by

$$\begin{aligned} \hat{y} &= 0 \\ \hat{r} &= \mu + r^* + \tau \end{aligned}$$

The phase diagram for this system is shown in Figure A.2.1. The slope of the locus YY showing stationary values for y is always positive as

$$\left. \frac{dr}{dy} \right|_{Dy=0} = \frac{\phi(\gamma + \lambda\delta)}{\lambda\delta} . \quad \text{The slope of the locus } RR \text{ giving stationary values}$$

$$\text{for } r \text{ cannot be signed unambiguously as } \left. \frac{dr}{dy} \right|_{Dr=0} = \frac{\phi(k\delta + \gamma\phi - 1)}{k\delta} .$$

In the figure we show the case where $\phi < (1 - \delta k)/\gamma$, so $\left. \frac{dr}{dy} \right|_{Dr=0} < 0$.

As can be seen from the construction, this implies that the convergent path SS

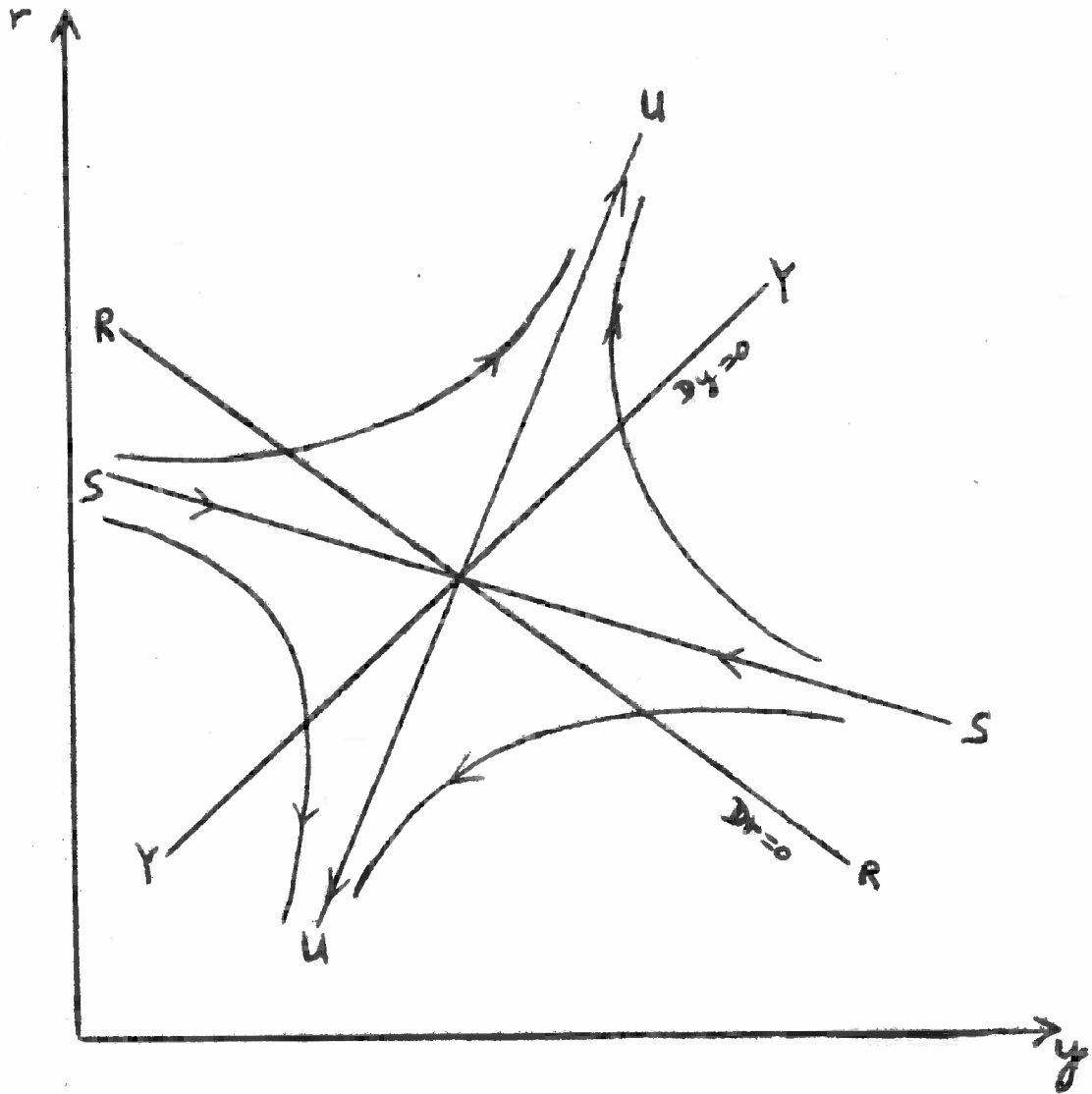

Figure A 2.1 The dynamic behaviour of output and the rate of interest.

also slopes down to the right. This corresponds to the case in the text, see Figure 6, where interest rates do not respond to a monetary slowdown by overshooting their long run equilibrium. This sort of interest rate overshooting will however, result when $\phi > (1 - \delta k)/\gamma$ so $\left. \frac{dr}{dy} \right|_{Dr=0} > 0$, (not shown).

In the intermediate case, where $\phi = (1 - \delta k)/\gamma$ the locus of stationary values for the rate of interest is horizontal and is coincident with the stable path.

Under the strong assumptions made in this paper both the rate of interest and the flow of income jump in response to monetary shocks, their instantaneous values being given by the intersection of the (predetermined) LM curve and the stable locus SS as shown in Figure. It was largely because the r, y formulation fails to make a sharp distinction between historically predetermined and flexibly adjusting variables that the formulation in terms of l and c was adopted in the text.

Appendix 3

The magnitude of the initial jump in c

The homogeneous part of the dynamic system in (14) can be represented as in A 3.1.

$$(A 3.1) \quad \begin{bmatrix} D\ell \\ Dc \end{bmatrix} = \begin{bmatrix} a_{11} & a_{12} \\ a_{21} & a_{22} \end{bmatrix} \begin{bmatrix} \ell \\ c \end{bmatrix} = A \begin{bmatrix} \ell \\ c \end{bmatrix}$$

We assume there to be one stable and one unstable root, i.e. $a_{11}a_{22} - a_{21}a_{12} < 0$.

Let X be the matrix whose columns are the right eigen-vectors of A.

$$X = \begin{bmatrix} x_{1s} & x_{1u} \\ x_{2s} & x_{2u} \end{bmatrix}$$

Here $\begin{bmatrix} x_{1s} \\ x_{2s} \end{bmatrix}$ is the eigen-vector corresponding to the stable eigen value

ρ_s and $\begin{bmatrix} x_{1u} \\ x_{2u} \end{bmatrix}$ is the eigen-vector corresponding to the unstable eigen value ρ_u .

We can now transform A 3.1 as follows:

$$(A 3.2) \quad X^{-1} \begin{bmatrix} D\ell \\ Dc \end{bmatrix} = X^{-1}AXX^{-1} \begin{bmatrix} \ell \\ c \end{bmatrix}$$

$$\text{Now } X^{-1}AX = \begin{bmatrix} \rho_s & 0 \\ 0 & \rho_u \end{bmatrix}$$

$$\text{and } X^{-1} = \frac{\begin{bmatrix} x_{2u} & -x_{1u} \\ -x_{2s} & -x_{1s} \end{bmatrix}}{x_{1s}x_{2u} - x_{2s}x_{1u}}$$

For the system (A 3.2) to converge to the long-run equilibrium it is necessary, as $\rho_u > 0$, that

$$(A 3.3) \quad \frac{-x_{2s} D\ell + x_{1s} Dc}{x_{1s}x_{2u} - x_{2s}x_{1u}} = \frac{\rho_u (-x_{2s} \ell + x_{1s} c)}{x_{1s}x_{2u} - x_{2s}x_{1u}} \equiv 0$$

This implies

$$-x_{2s} \ell + x_{1s} c \equiv 0$$

or

$$(A 3.4) \quad c = \frac{x_{2s}}{x_{1s}} \ell$$

This permits us to solve for c given the historically determined value of ℓ .

The eigen values of A are found by solving

$$|A - \lambda I| = 0$$

This yields

$$(A 3.5) \quad \rho_s = \frac{a_{11} + a_{22} - \sqrt{(a_{11} - a_{22})^2 + 4a_{21}a_{12}}}{2}$$

The eigen vector corresponding to ρ_s is then found by solving

$$(A 3.6) \quad A \begin{bmatrix} x_{1s} \\ x_{2s} \end{bmatrix} = \rho_s \begin{bmatrix} x_{1s} \\ x_{2s} \end{bmatrix}$$

This yields, normalizing so that $x_{2s} = 1$

$$(A 3.7) \quad \begin{bmatrix} x_{1s} \\ x_{2s} \end{bmatrix} = \begin{bmatrix} \frac{a_{12}}{\rho_s - a_{11}} \\ 1 \end{bmatrix}$$

Therefore,

$$(A 3.8) \quad c = \left(\frac{\rho_s - a_{11}}{a_{12}} \right) \ell = \left[\frac{a_{11} + a_{22} - \sqrt{(a_{11} - a_{22})^2 + 4a_{21}a_{12}}}{2} - a_{11} \right] a_{12}^{-1} \ell$$

Noting from (14) that

$$a_{11} = \frac{\phi\gamma}{\Delta}$$

$$a_{12} = \frac{\phi\lambda\delta}{\Delta}$$

$$a_{21} = \frac{1 + \nu\sigma\gamma}{\Delta}$$

$$a_{22} = \frac{\delta(\phi\lambda - k + \lambda\nu\sigma)}{\Delta} + \sigma\eta$$

we can write (A 3.9) as

$$(A 3.9) \quad c = v\ell = \begin{pmatrix} \rho_s - \phi\gamma\Delta^{-1} \\ \phi\lambda\delta\Delta^{-1} \end{pmatrix} \ell$$

$$(A 3.10) \quad v = \frac{-\phi\gamma + \delta(\phi\lambda - k + \lambda\nu\sigma) + \sigma\eta\Delta + \sqrt{[(\phi\gamma - \delta(\phi\lambda - k + \lambda\nu\sigma) - \sigma\eta\Delta)^2 + 4\phi\lambda\delta(1 + \nu\sigma\gamma)]}}{2\phi\lambda\delta}$$

To find the change in the magnitude of the jump at a given value of ℓ as σ increases we derive $\frac{dv}{d\sigma}$.

$$(A 3.11) \quad \frac{dv}{d\sigma} = \frac{\delta\lambda\nu + \eta\Delta + \left[(\phi\gamma - \delta(\phi\lambda - k + \lambda\nu\sigma) - \sigma\eta\Delta)^2 + 4\phi\lambda\delta(1 + \nu\sigma\gamma) \right]^{-\frac{1}{2}} \left\{ \phi\gamma(\delta\lambda\nu - \eta\Delta) + [\delta(\phi\lambda - k + \lambda\nu\sigma) + \sigma\eta\Delta] [\delta\lambda\nu + \eta\Delta] \right\}}{2\phi\lambda\delta}$$

If the responsiveness of aggregate demand to changes in the real interest rate is very low (i.e. $\gamma = 0$), this simplifies to:

$$(A 3.12) \quad \frac{dv}{d\sigma} = \frac{(\delta\nu - \eta)}{2\phi\delta} \left[1 + \frac{\delta(\phi\lambda - k) + \lambda\sigma(\delta\nu - \eta)}{\sqrt{[\delta(\phi\lambda - k) + \lambda\sigma(\delta\nu - \eta)]^2 + 4\phi\lambda\delta}} \right]$$

Therefore, $\frac{dv}{d\sigma}$ will be negative if $\delta\nu < \eta$ and positive if $\delta\nu > \eta$.

This is illustrated in Figure 10 in the text.

Appendix 4

An announced future reduction in μ .

Ignoring exogenous variables other than μ , the dynamic model of section II can be represented as:

$$(A4.1) \quad \begin{bmatrix} D\ell \\ Dc \end{bmatrix} = \begin{bmatrix} a_{11} & a_{12} \\ a_{21} & a_{22} \end{bmatrix} \begin{bmatrix} \ell \\ c \end{bmatrix} + \begin{bmatrix} b_{11} \\ b_{21} \end{bmatrix} \mu = A \begin{bmatrix} \ell \\ c \end{bmatrix} + B\mu$$

The a_{ij} and b_{ij} are defined in Tables 1 and 2.

At $t = 0$ there is an announcement of a previously unanticipated reduction in μ at $t = T > 0$. This announcement is believed and the reduction in μ is indeed implemented at $t = T$. Thus the path of μ is given by

$$(A4.2) \quad \mu(t) = \begin{cases} \bar{\mu} & t < T \\ \underline{\mu} & t \geq T \end{cases}$$

with $\underline{\mu} < \bar{\mu}$.

Note that we assume that $\mu(t) = \bar{\mu}$ also for $t \leq 0$. Without loss of generality we assume that before the policy announcement the economy is in long run equilibrium, i.e.

$$(A4.3) \quad \begin{bmatrix} \ell(t) \\ c(t) \end{bmatrix} = -A^{-1}B\bar{\mu} = \begin{bmatrix} \bar{z}_\ell \\ \bar{z}_c \end{bmatrix} \quad \text{for } t < 0.$$

Let $\mu(t, \tau)$ be the value of μ at time t , anticipated at time τ , $\tau \leq t$.

$$(A4.4) \quad \mu(t, \tau) = \begin{cases} \bar{\mu} & \tau < 0 \\ \mu(t) & \tau \geq 0. \end{cases}$$

The following solution method is based on Wilson (1979).

We assume that A has one stable characteristic root $\rho_s < 0$ and one unstable characteristic root $\rho_u > 0$.

There is an initial condition for l ,

$$(A4.5) \quad l(0) = l_0$$

We also impose the terminal or transversality condition that as $t \rightarrow \infty$, $l(t)$ and $c(t)$ converge to their long run equilibrium values, i.e.

$$(A4.6) \quad \lim_{t \rightarrow \infty} \begin{pmatrix} l(t) \\ c(t) \end{pmatrix} = -A^{-1}B\bar{u} = \begin{pmatrix} \bar{z}_l \\ \bar{z}_c \end{pmatrix}$$

A further condition on the solution trajectory is that it is continuous after $t = 0$.

The solution to the homogeneous equation

$$\begin{pmatrix} Dl \\ Dc \end{pmatrix} = A \begin{pmatrix} l \\ c \end{pmatrix} \quad \text{is, assuming that } a_{12} \neq 0,$$

$$(A4.7a) \quad l_h(t) = K_1 e^{\rho_s t} + K_2 e^{\rho_u t}$$

$$(A4.7b) \quad c_h(t) = \left[\frac{\rho_s - a_{11}}{a_{12}} \right] K_1 e^{\rho_s t} + \left[\frac{\rho_u - a_{11}}{a_{12}} \right] K_2 e^{\rho_u t}$$

K_1 and K_2 are arbitrary constants.

For $t \geq T$ a particular solution is

$$\begin{pmatrix} l_p(t) \\ c_p(t) \end{pmatrix} = -A^{-1}B\bar{u} = \begin{pmatrix} \bar{z}_l \\ \bar{z}_c \end{pmatrix}$$

The general solution for $t \geq T$ is therefore given by

$$(A4.8a) \quad l(t) = \bar{K}_1 e^{\rho_s t} + \bar{K}_2 e^{\rho_u t} + \bar{z}_l$$

$$(A4.8b) \quad c(t) = \left[\frac{\rho_s - a_{11}}{a_{12}} \right] \bar{K}_1 e^{\rho_s t} + \left[\frac{\rho_u - a_{11}}{a_{12}} \right] \bar{K}_2 e^{\rho_u t} + \bar{z}_c$$

Here \bar{K}_1 and \bar{K}_2 are the arbitrary constants appropriate to the solution interval $t \geq T$.

From the transversality condition (A4.6) and $\rho_u > 0$ it follows that $\bar{K}_2 = 0$. This places the system at $t = T$ on the stable saddlepath through the new long-run equilibrium, where it will remain for $t > T$.

$$(A4.9a) \quad \ell(t) = \bar{K}_1 e^{\rho_s t} + \bar{z}_\ell.$$

$$(A4.9b) \quad c(t) = \left[\frac{\rho_s - a_{11}}{a_{12}} \right] \bar{K}_1 e^{\rho_s t} + \bar{z}_c.$$

The point on the convergent saddlepath where the system arrives at $t = T$ depends on ℓ_0 , the initial value for ℓ .

For $0 \leq t < T$ the general solution is given by:

$$(A4.10a) \quad \ell(t) = \bar{K}_1 e^{\rho_s t} + \bar{K}_2 e^{\rho_u t} + \bar{z}_\ell.$$

$$(A4.10b) \quad c(t) = \left[\frac{\rho_s - a_{11}}{a_{12}} \right] \bar{K}_1 e^{\rho_s t} + \left[\frac{\rho_u - a_{22}}{a_{12}} \right] \bar{K}_2 e^{\rho_u t} + \bar{z}_c.$$

\bar{K}_1 and \bar{K}_2 are the arbitrary constants appropriate to the solution interval $0 \leq t < T$.

The condition that there be no jump in $c(t)$ at $t = T$, $\lim_{t \rightarrow T^-} c(t) = \lim_{t \rightarrow T^+} c(t)$, implies from (A4.10b) and (A4.9b) that:

$$(A4.11) \quad \left[\frac{\rho_s - a_{11}}{a_{12}} \right] \bar{K}_1 e^{\rho_s T} + \left[\frac{\rho_u - a_{22}}{a_{12}} \right] \bar{K}_2 e^{\rho_u T} + \bar{z}_c = \left[\frac{\rho_s - a_{11}}{a_{12}} \right] \bar{K}_1 e^{\rho_s T} + \bar{z}_c$$

The condition that the solution for $\ell(t)$ be continuous similarly implies:

$$(A4.12) \quad \bar{K}_1 e^{\rho_s T} + \bar{K}_2 e^{\rho_u T} + \bar{z}_\ell = \bar{K}_1 e^{\rho_s T} + \bar{z}_\ell.$$

The complete solution can therefore be summarized as:

For $t < 0$:

$$l(t) = \bar{z}_l$$

$$c(t) = \bar{z}_c$$

For $0 \leq t < T$:

$$l(t) = \bar{K}_1 e^{\rho_s t} + \bar{K}_2 e^{\rho_u t} + \bar{z}_l$$

$$c(t) = \left(\frac{\rho_u - a_{11}}{a_{12}} \right) \bar{K}_1 e^{\rho_s t} + \left(\frac{\rho_u - a_{22}}{a_{12}} \right) \bar{K}_2 e^{\rho_u t} + \bar{z}_c$$

For $t \geq T$:

$$l(t) = \bar{\bar{K}}_1 e^{\rho_s t} + \bar{z}_l$$

$$c(t) = \left(\frac{\rho_s - a_{11}}{a_{12}} \right) \bar{\bar{K}}_1 e^{\rho_s t} + \bar{z}_c$$

\bar{K}_1 , \bar{K}_2 and $\bar{\bar{K}}_1$ are determined by:

$$l(0) = l_0$$

and

$$\left(\frac{\rho_s - a_{11}}{a_{12}} \right) e^{\rho_s T} (\bar{K}_1 - \bar{\bar{K}}_1) + \left(\frac{\rho_u - a_{22}}{a_{12}} \right) \bar{K}_2 e^{\rho_u T} = \bar{z}_c - \bar{z}_c$$

$$e^{\rho_s T} (\bar{K}_1 - \bar{\bar{K}}_1) + \bar{K}_2 e^{\rho_u T} = \bar{z}_l - \bar{z}_l$$

References

- Barro, Robert J. [1976] "Rational Expectations and the Role of Monetary Policy", Journal of Monetary Economics, 2, January, pp. 1095-1117.
- Buiter, W.H. and D.D. Purvis [1980] "Oil, Disinflation and Export Competitiveness", mimeo.
- Dornbusch, R. [1976] "Exchange Rate Dynamics", Journal of Political Economy, 84, December, pp. 1161-1176.
- _____ [1979] "Exchange Rate Rules and Macroeconomic Stability", mimeo.
- Flood, R.P. and N.P. Marion [1980] "The Transmission of Disturbances Under Alternative Exchange Rate Regimes with Optimal Indexing", National Bureau of Economic Research Working Paper No. 500, July.
- Forsyth, P.J. and J.A. Kay [1980] "The Economic Implications of North Sea Oil Revenues", Fiscal Studies, 1, July pp. 1-28.
- Frenkel, Jacob A. and Carlos A. Rodriguez [1980] "Exchange Rate Dynamics and the Overshooting Hypothesis", mimeo, August.
- Greenwell, W. & Co. [1980]. Monetary Bulletin, No. 106, June, London, W. Greenwell & Co.
- Hacche, G. [1974] "The Demand for Money in the United Kingdom : Experience since 1971", Bank of England Quarterly Bulletin, 14, September, pp. 284-305.
- Krugman, P. [1980] "Anti-inflationary Policy and the Exchange Rate", mimeo.
- Laidler D. [1975] Essays in Money and Inflation, Manchester: Manchester University Press.
- Liviatan, N. [1980] "Anti-inflationary Monetary Policy and the Capital Import Tax", Warwick Economic Research Paper, No. 171.
- Lucas, Robert E. [1972] "Expectations and the Neutrality of Money", Journal of Economic Theory, 4, April, pp. 102-124.
- _____ [1975] "An Equilibrium Model of the Business Cycle", Journal of Political Economy, 83, December, pp. 1113-44.
- Minford, Patrick [1980] "A Rational Expectations Model of the U.K. under Fixed and Floating Exchange Rates" in The State of Macroeconomics, K. Brunner and A. Meltzer eds, Carnegie-Rochester Conference Series on Public Policy.
- Sargent, Thomas and Neil Wallace [1975] "Rational Expectations, the Optimal Monetary Instrument and the Optimal Money Supply Rule", Journal of Political Economy, 83, April, pp. 241-254.
- _____ [1976] "Rational Expectations and the Theory of Economic Policy", Journal of Monetary Economics, 2, April, p. 1-44.

Tobin, James and W.C. Brainard [1963] "Financial Intermediaries and the Effectiveness of Monetary Controls", American Economic Review, 53, May, pp. 383-400.

Treasury and Civil Service Committee [1980] Memoranda on Monetary Policy, HC720, London, H.M.S.O.

Wilson, Charles A. [1979] "Anticipated Shocks and Exchange Rate Dynamics", Journal of Political Economy, 87, June, pp. 636-647.