

THz in vivo sensing: real world applications

Dr. Arturo Ignacio Hernandez Serrano
Research fellow
Arturo.Hernandez-Serrano@warwick.ac.uk

Emma MacPherson Terahertz Group

Electromagnetic spectra

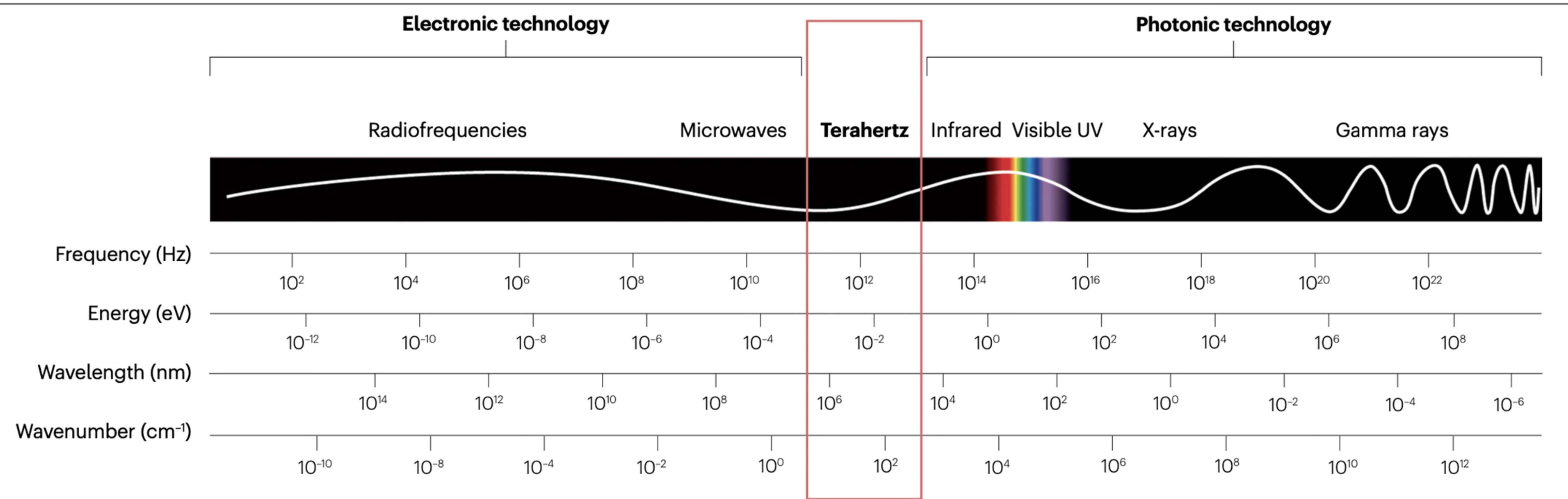

Koch, M., Mittleman, D.M., Ornik, J. *et al.* Terahertz time-domain spectroscopy. *Nat Rev Methods Primers* **3**, 48 (2023). <https://doi.org/10.1038/s43586-023-00232-z>

Terahertz waves

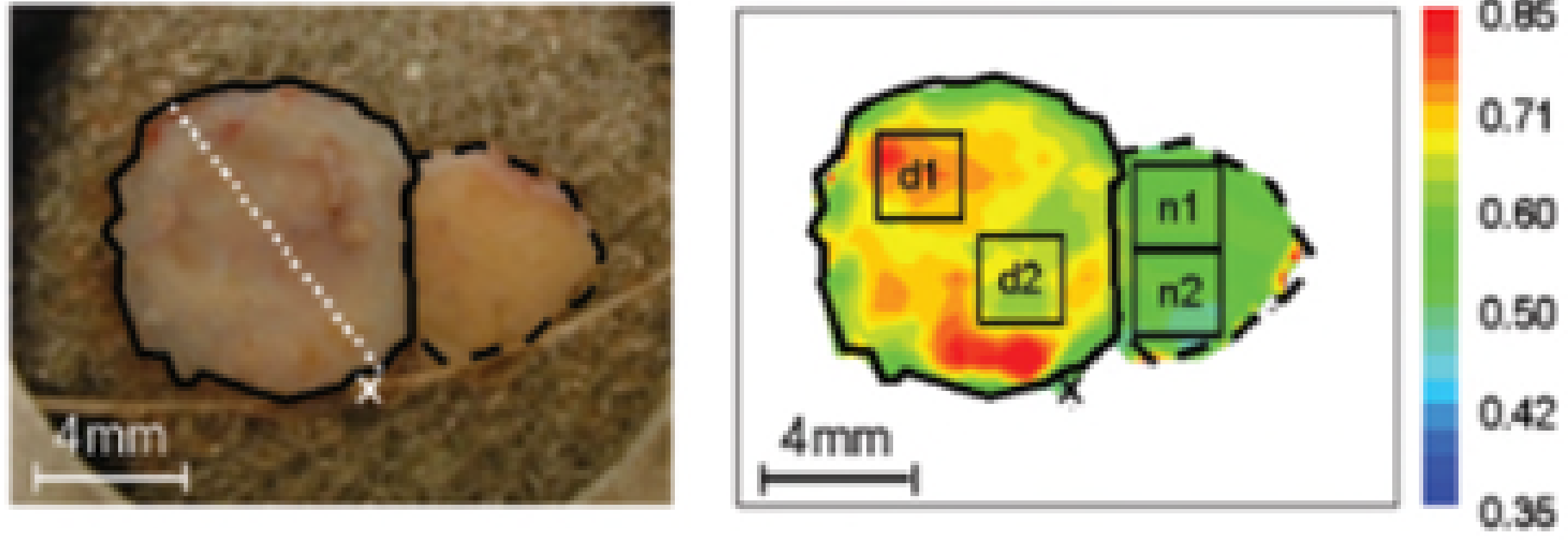

R. M. Woodward (2003) BCC cancer

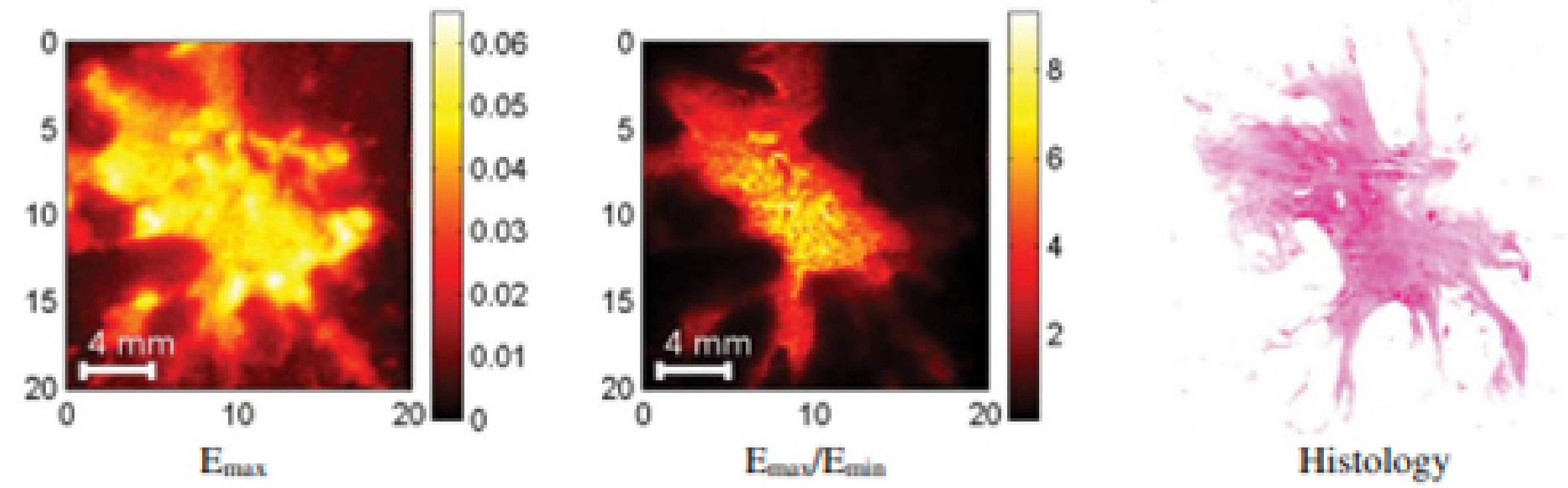
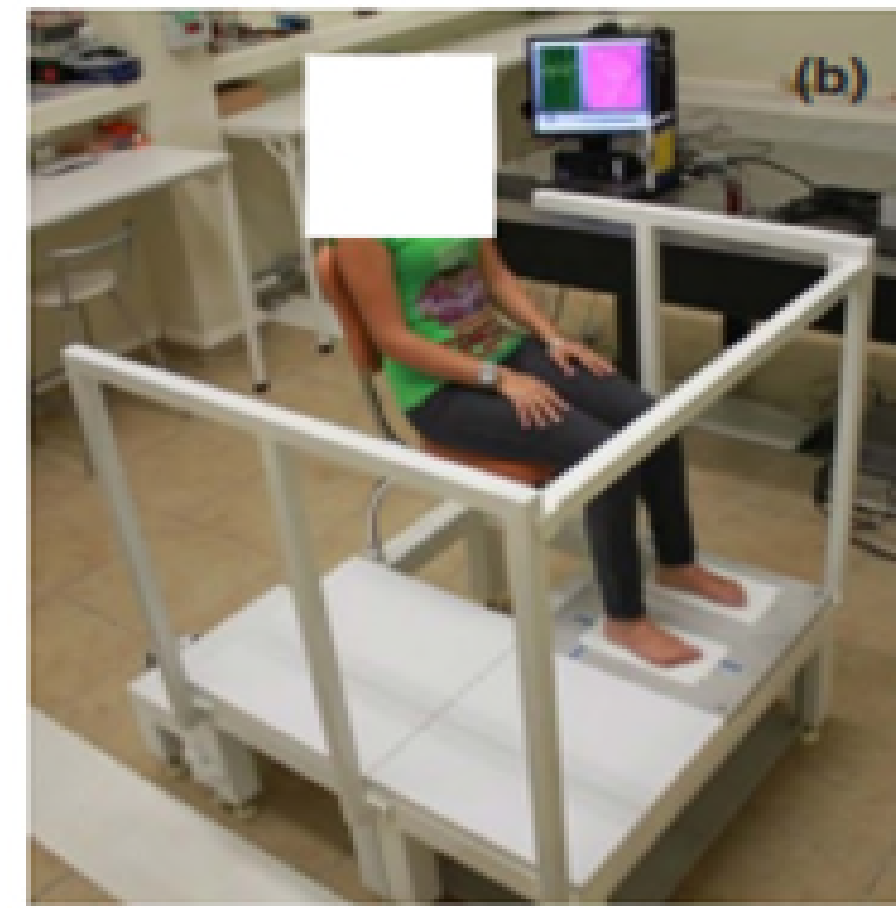

P. C. Ashworth (2009) Human breast cancer

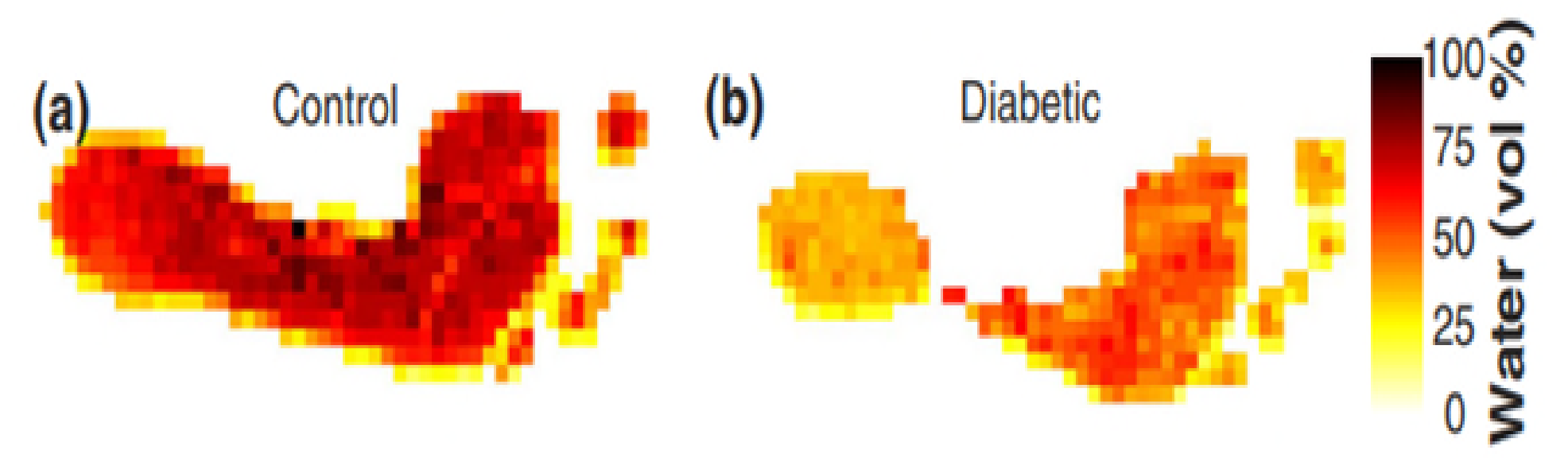

G.G. Hernandez-Cardoso (2009) Diabetic foot syndrome

Penetration depth

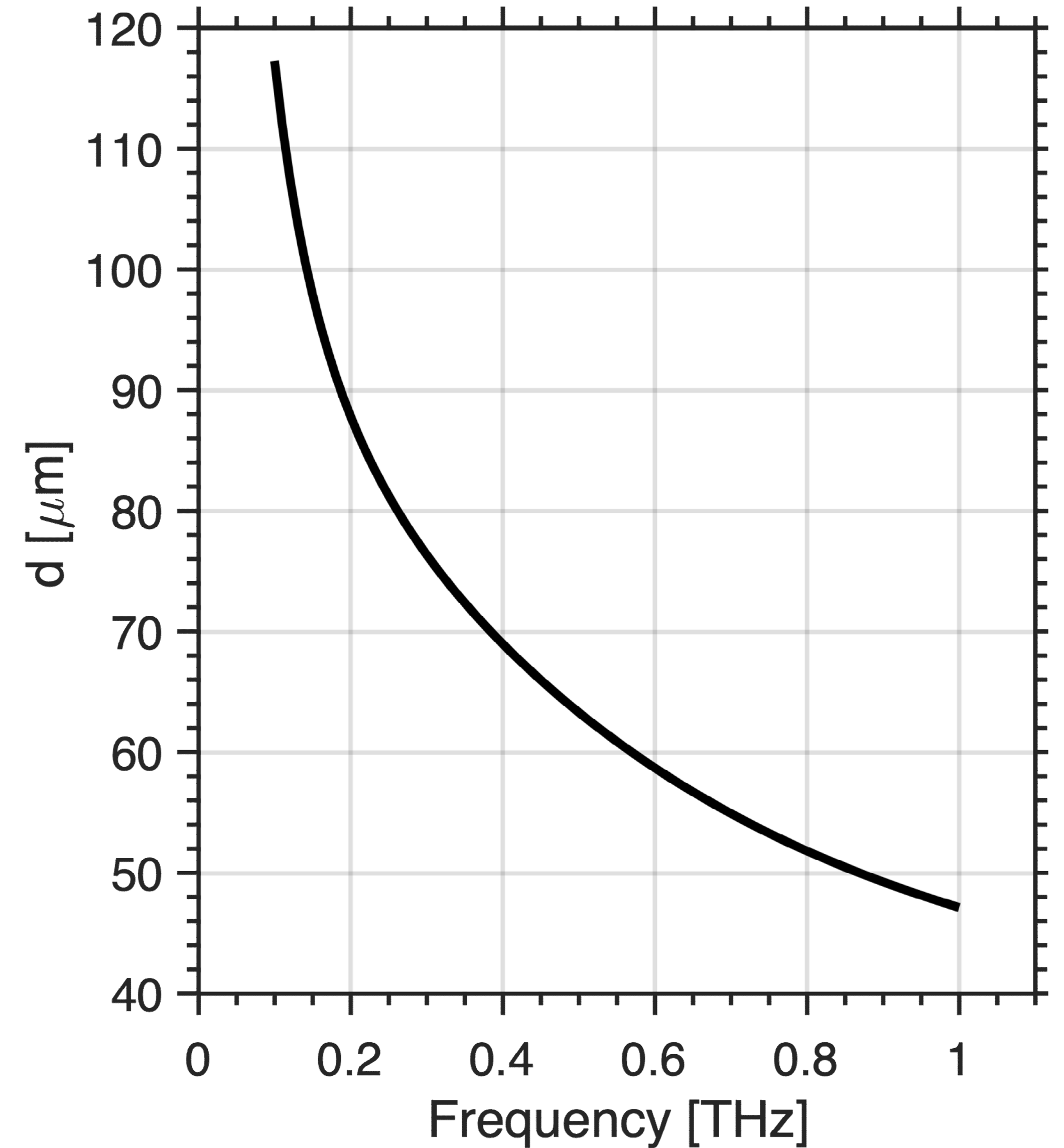
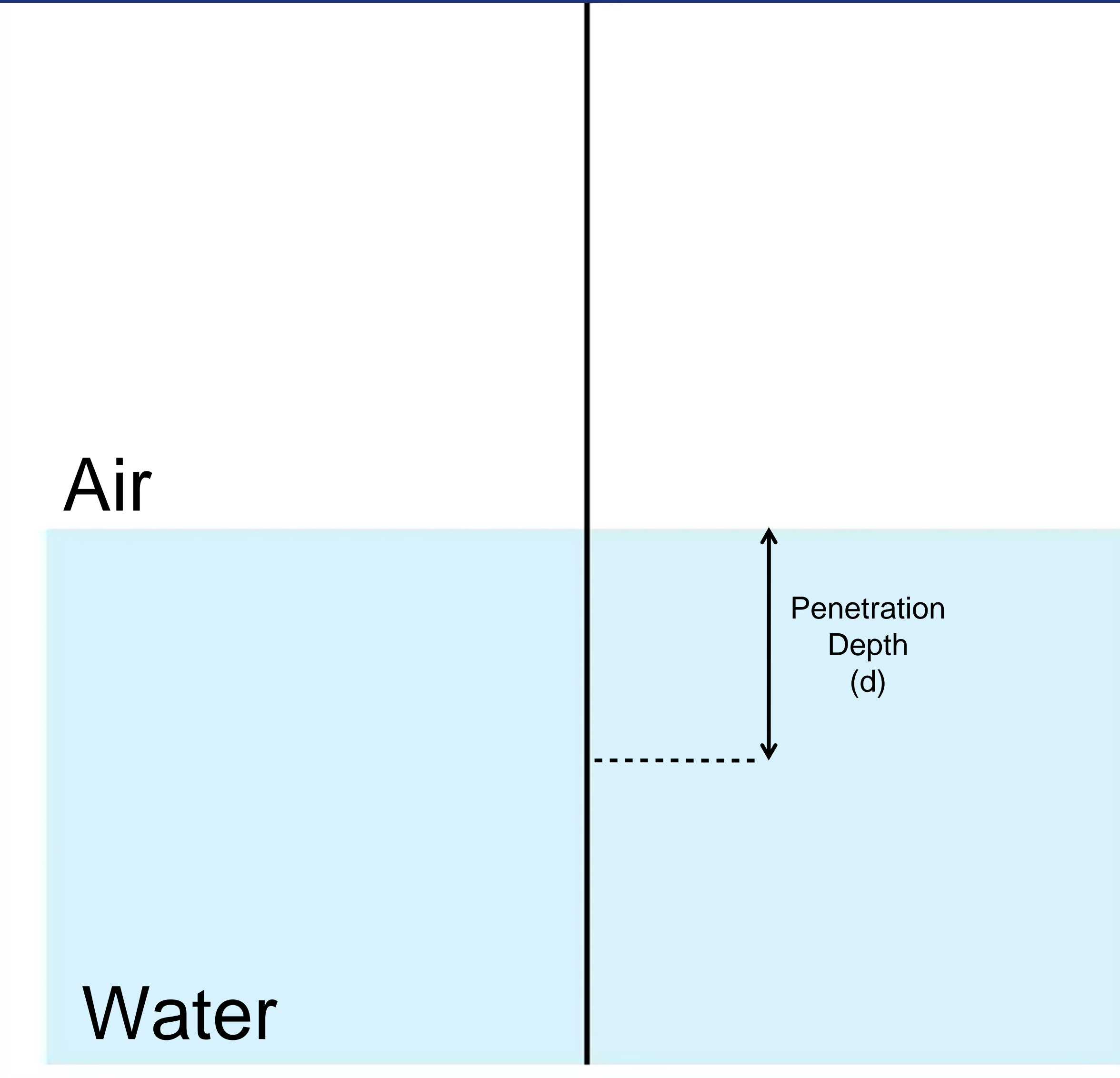

Penetration depth

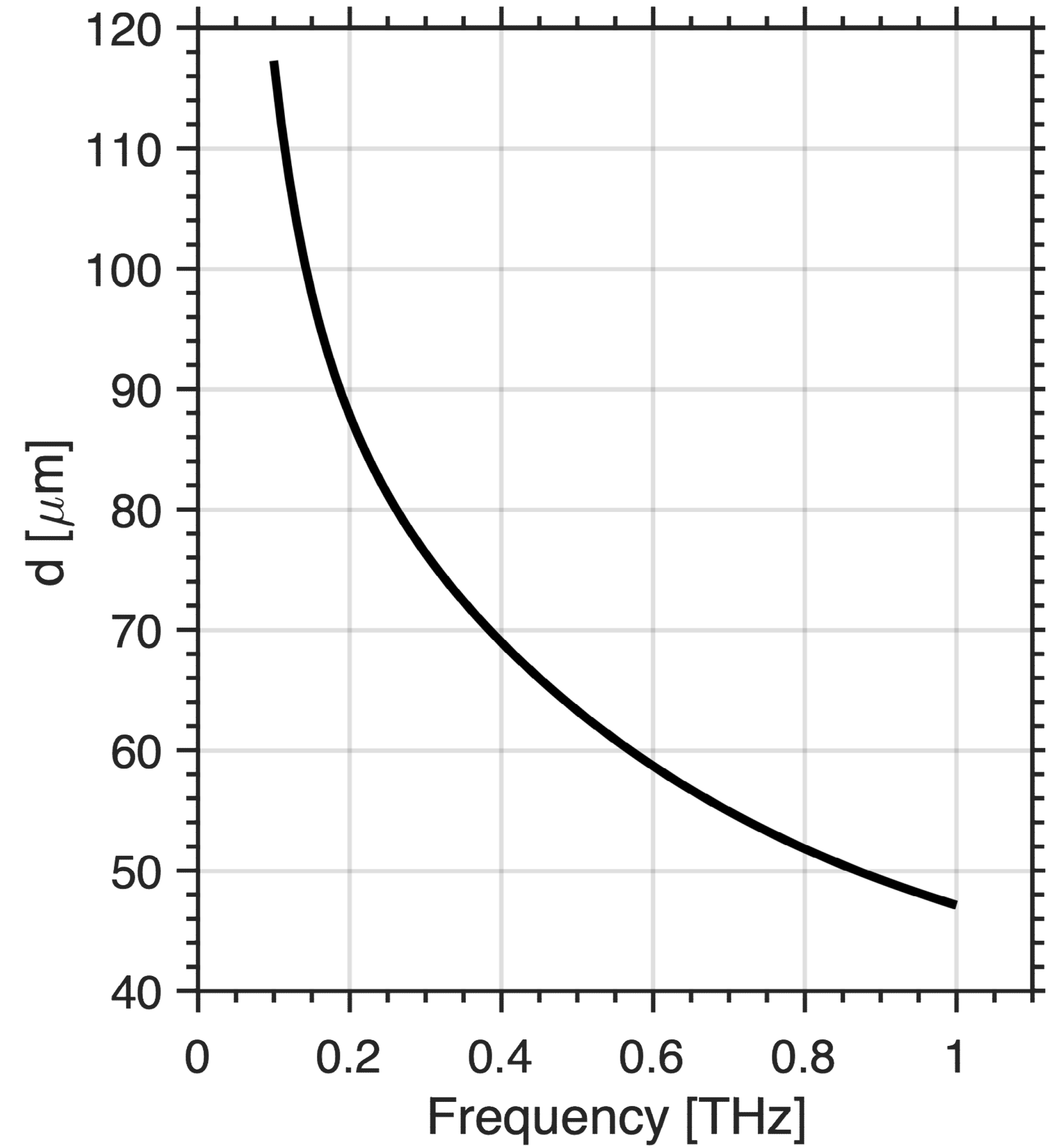
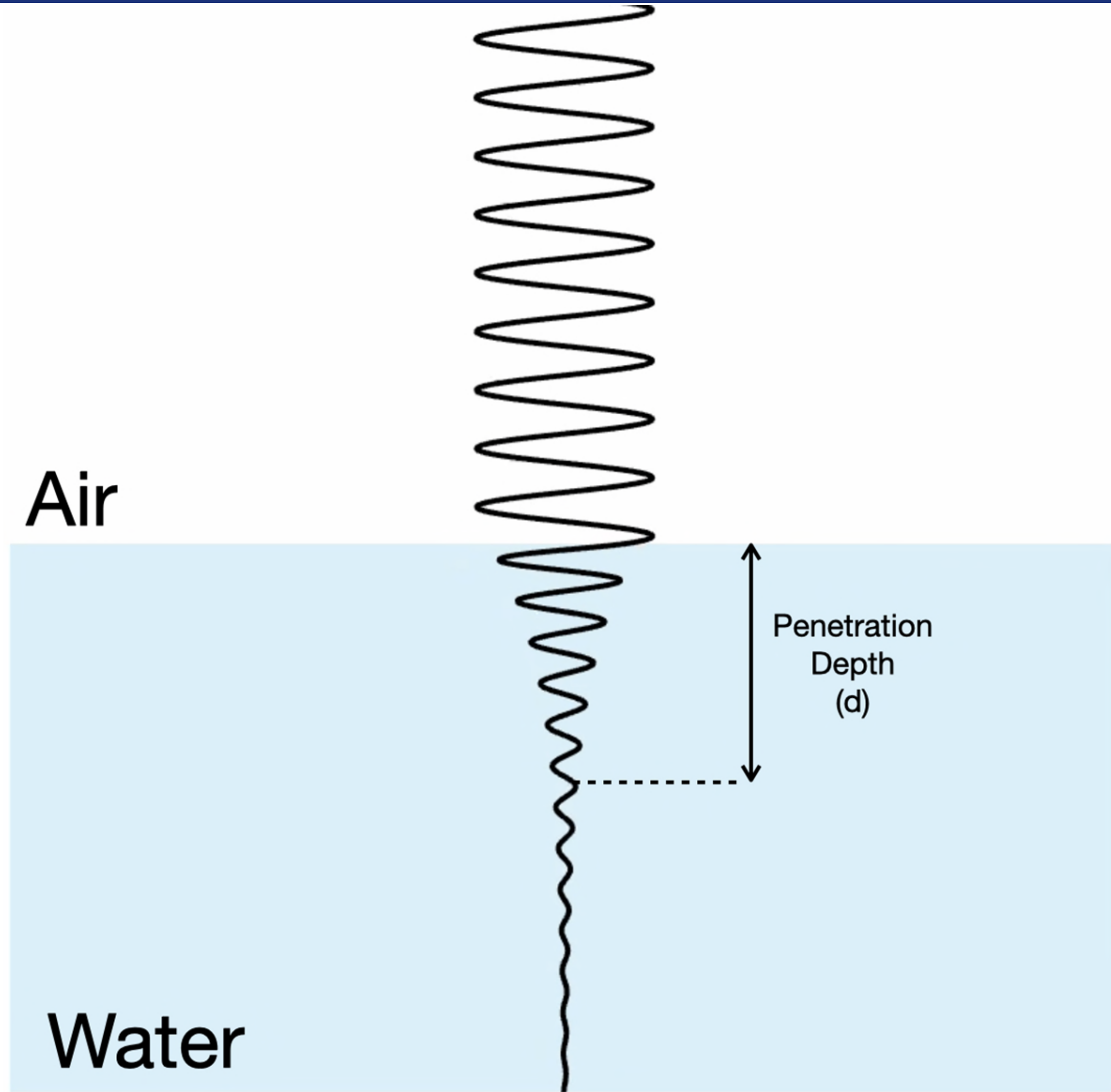

Terahertz-Time-Domain-Spectrometer

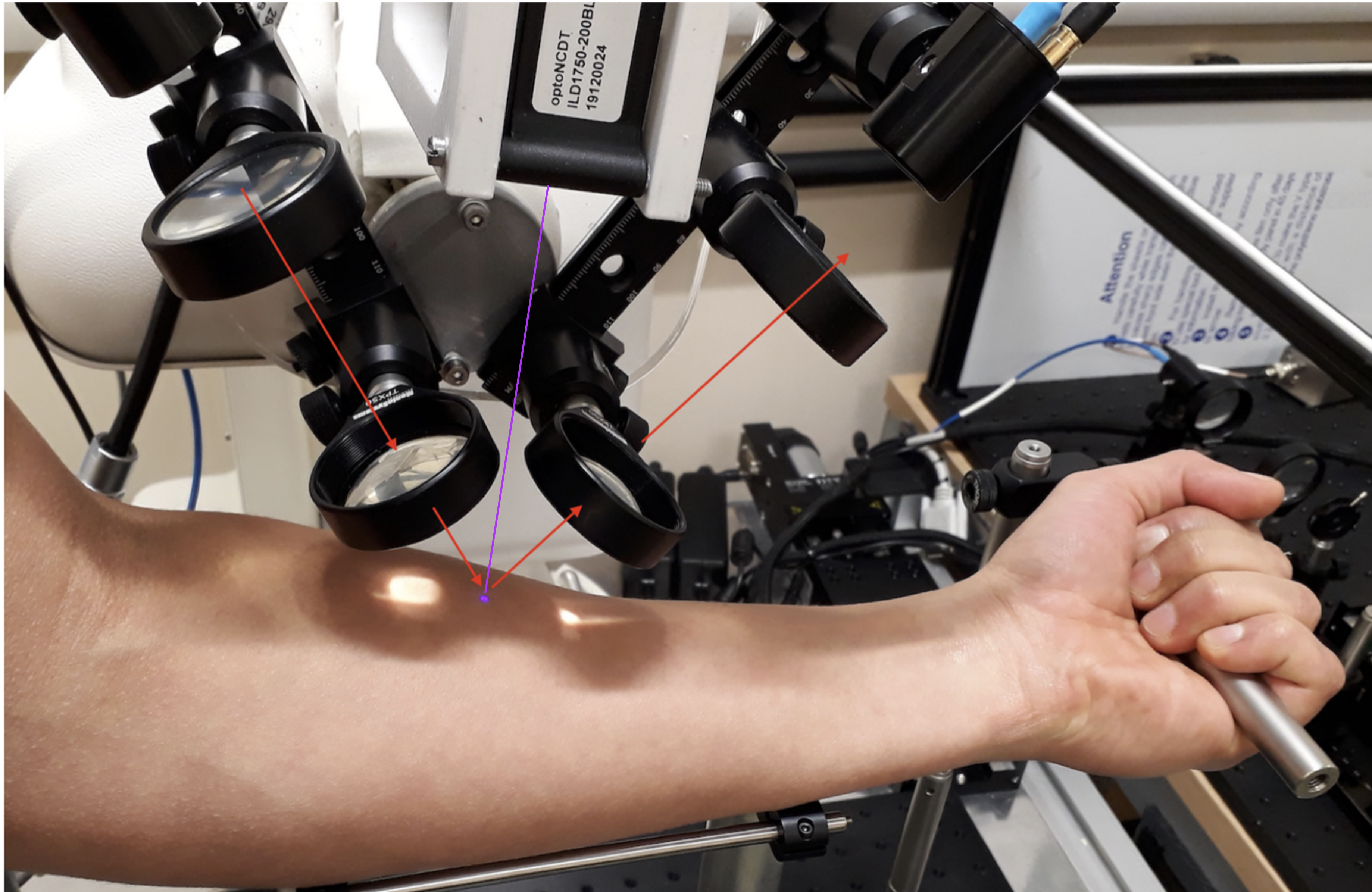

Terahertz-Time-Domain-Spectrometer

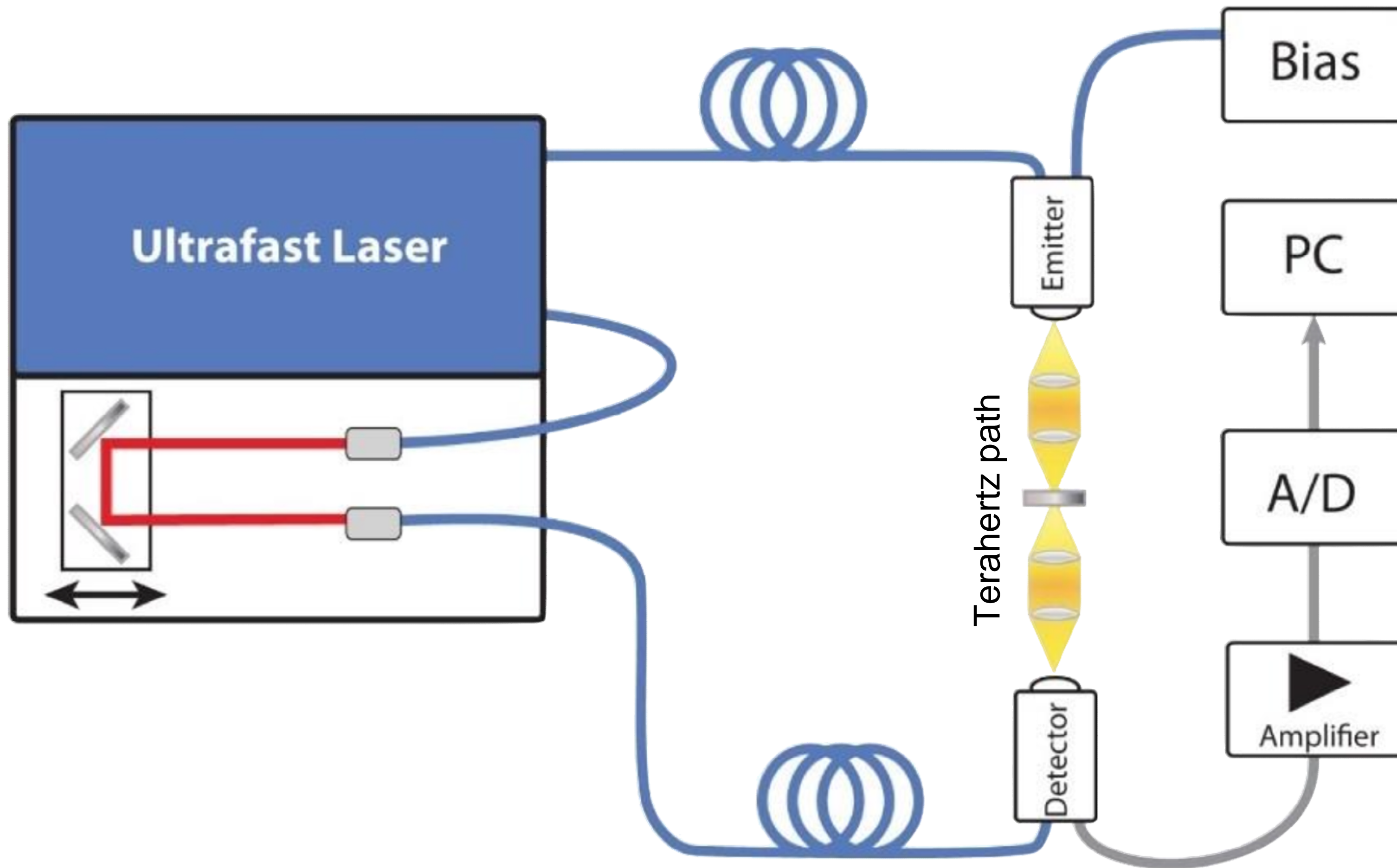

Terahertz Time-Domain Spectrometer

Source: Menlo systems

Terahertz-Time-Domain-Spectrometer

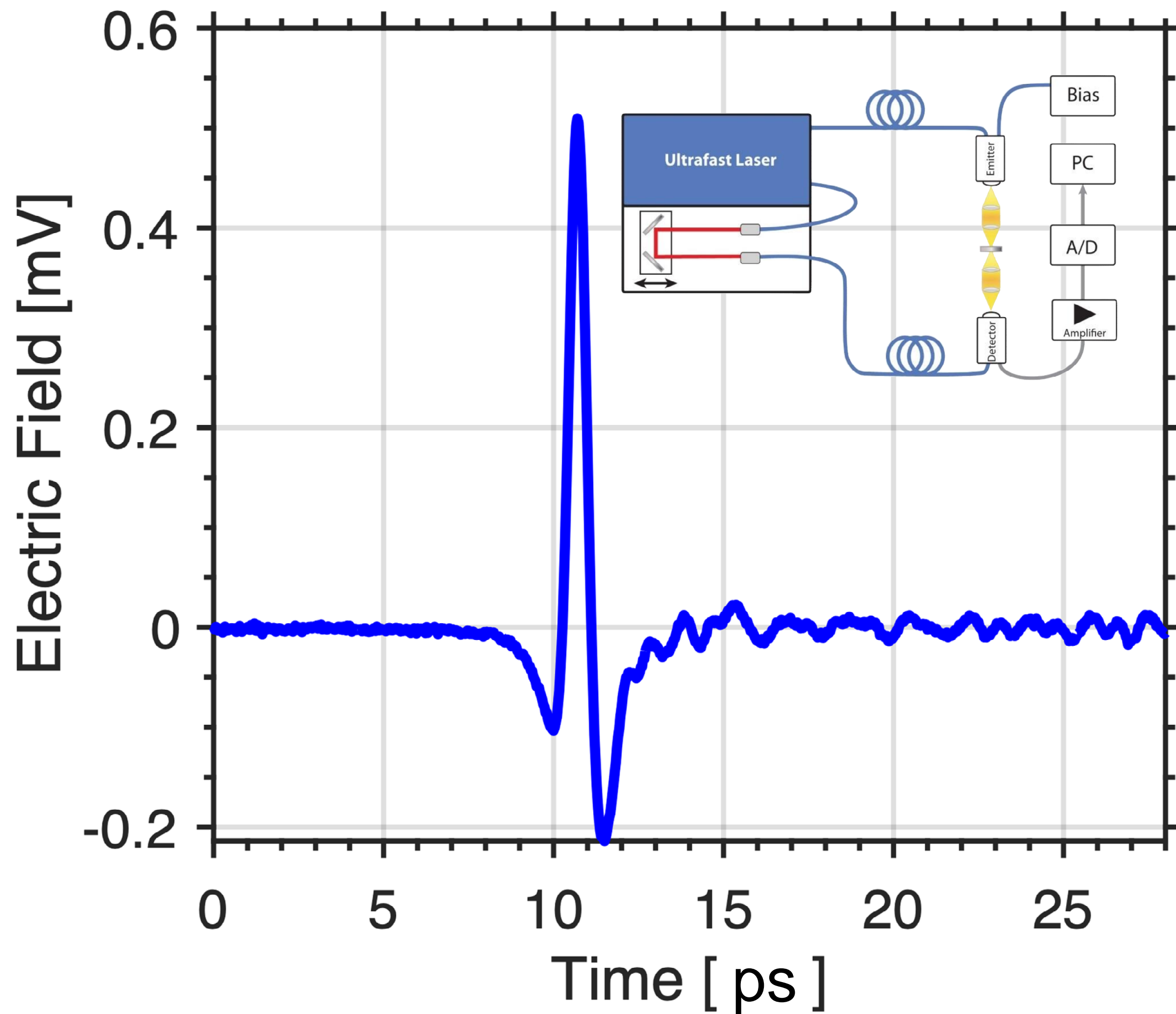

FFT

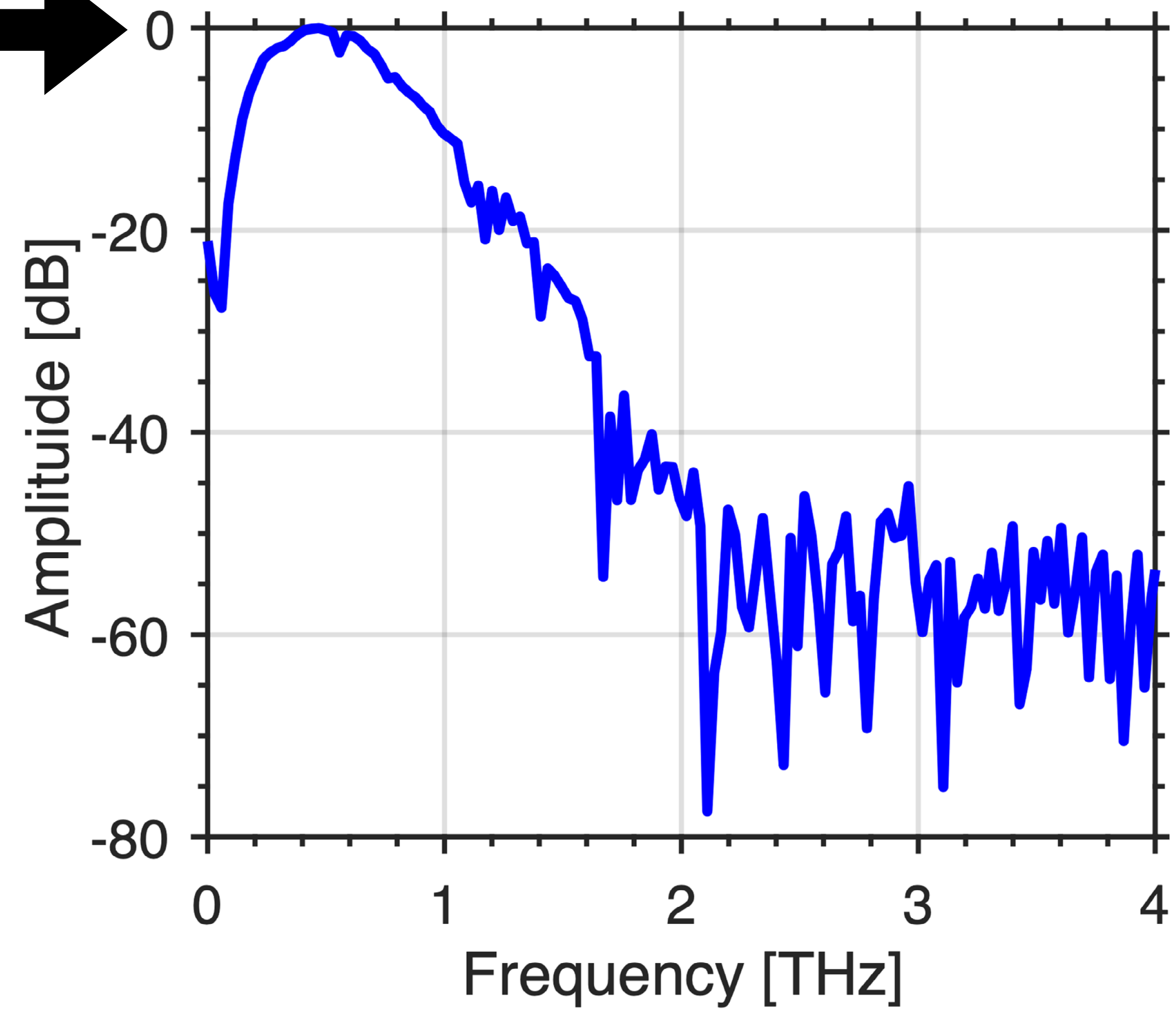
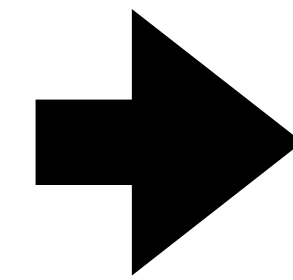

Terahertz Ellipsometry

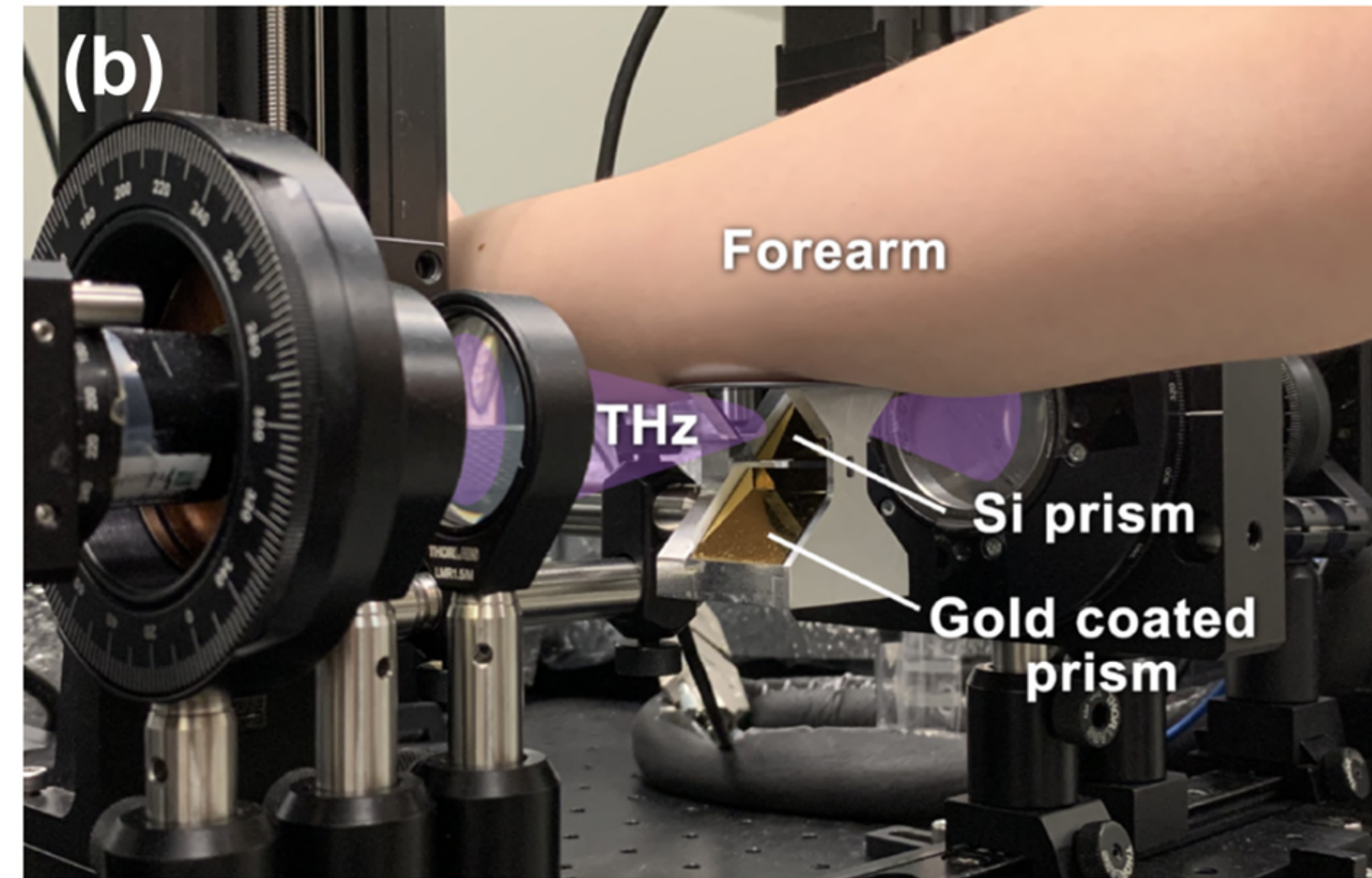
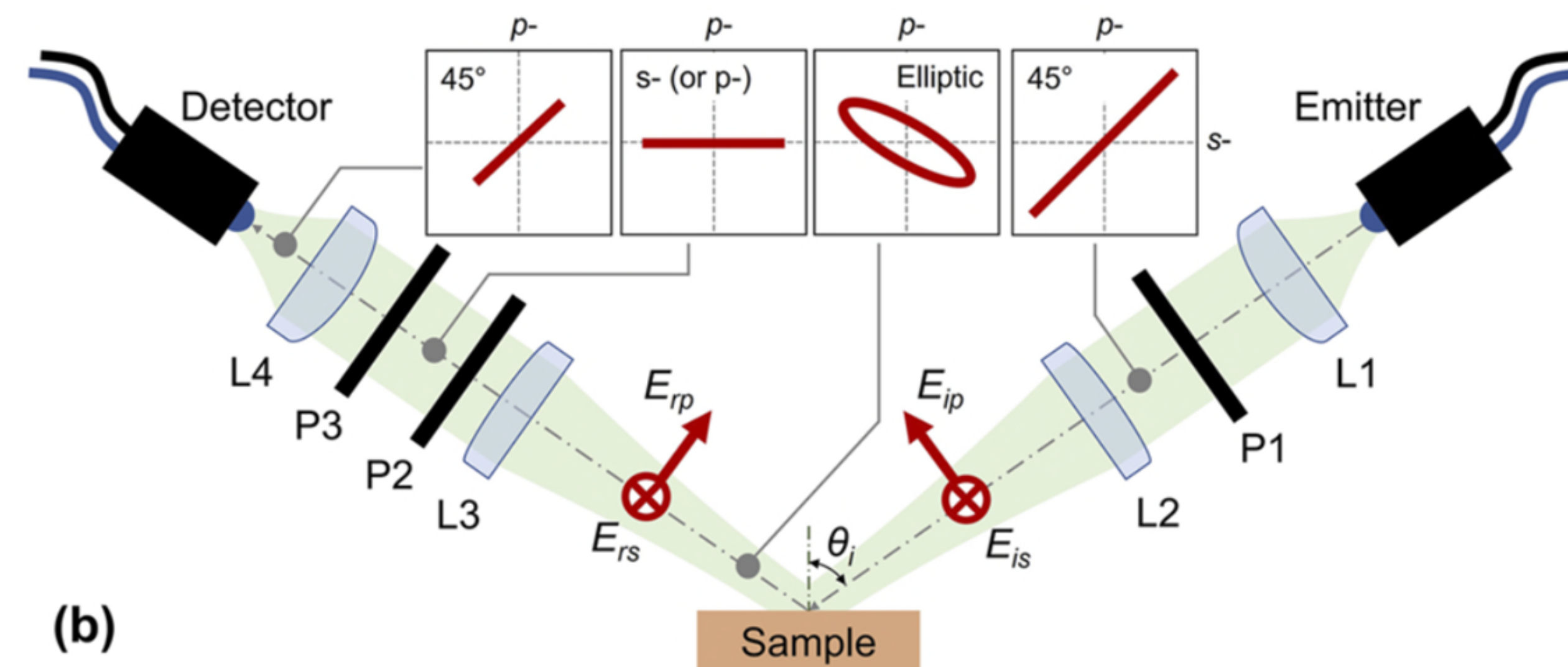
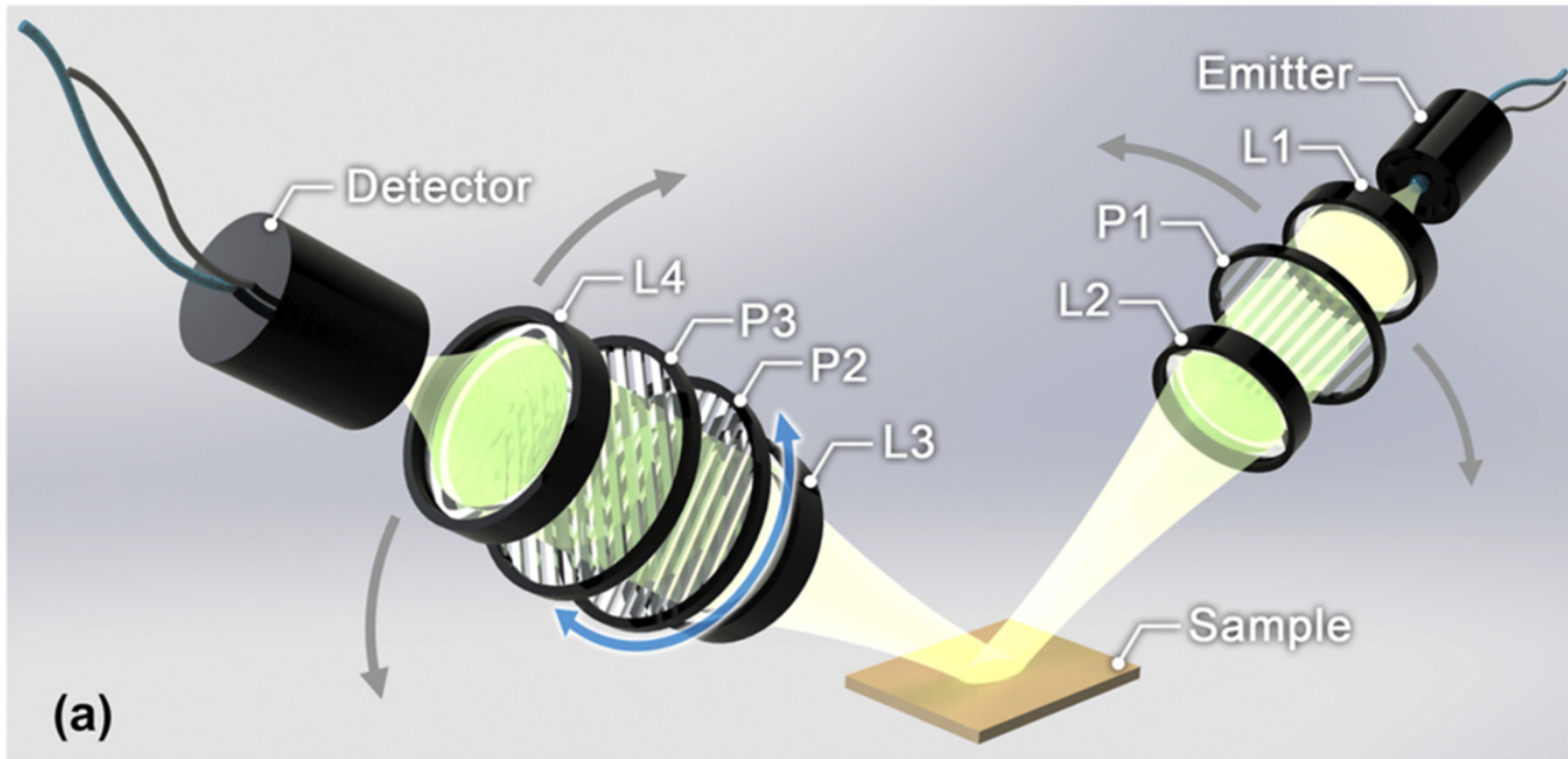

Terahertz Ellipsometry

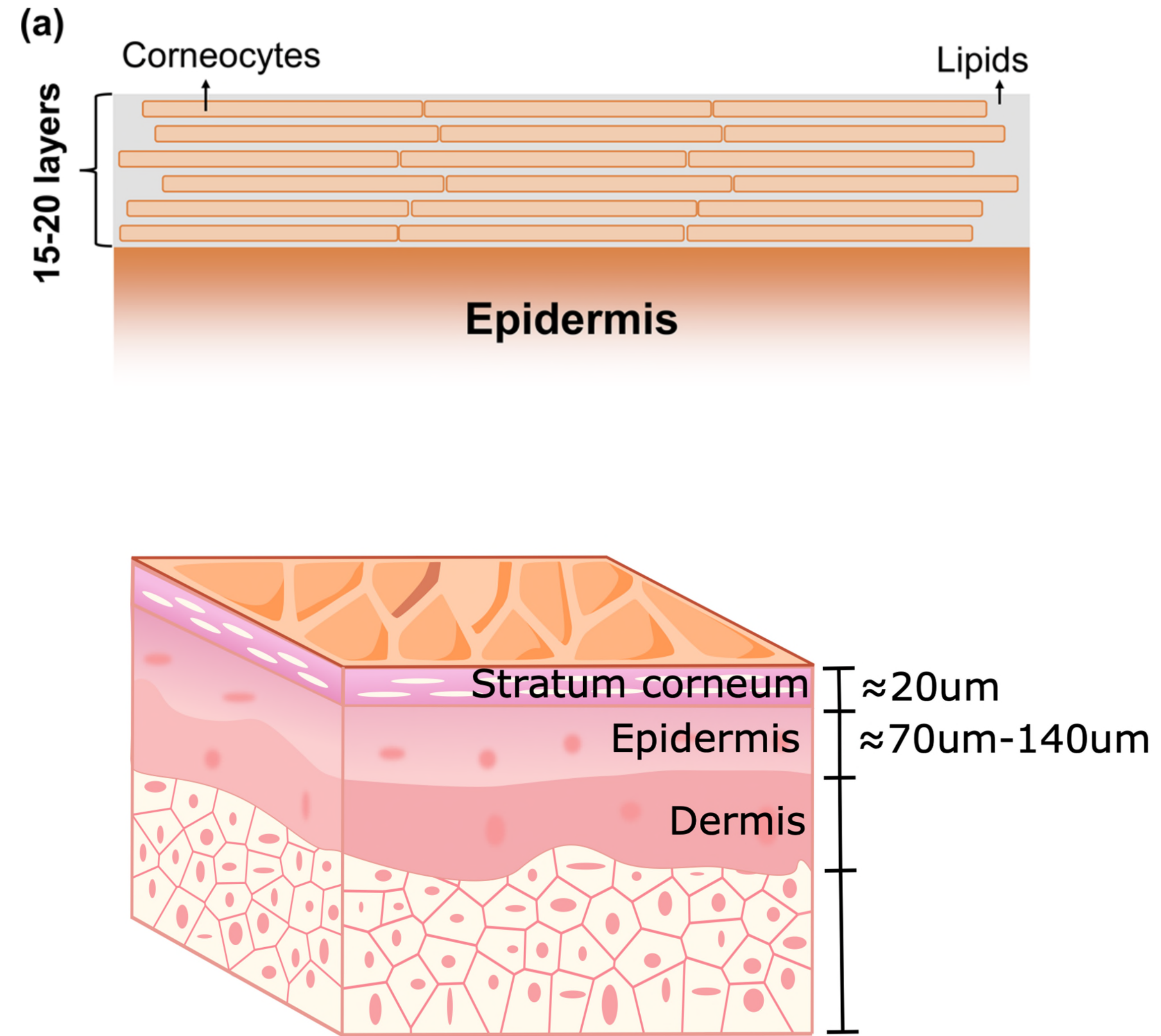
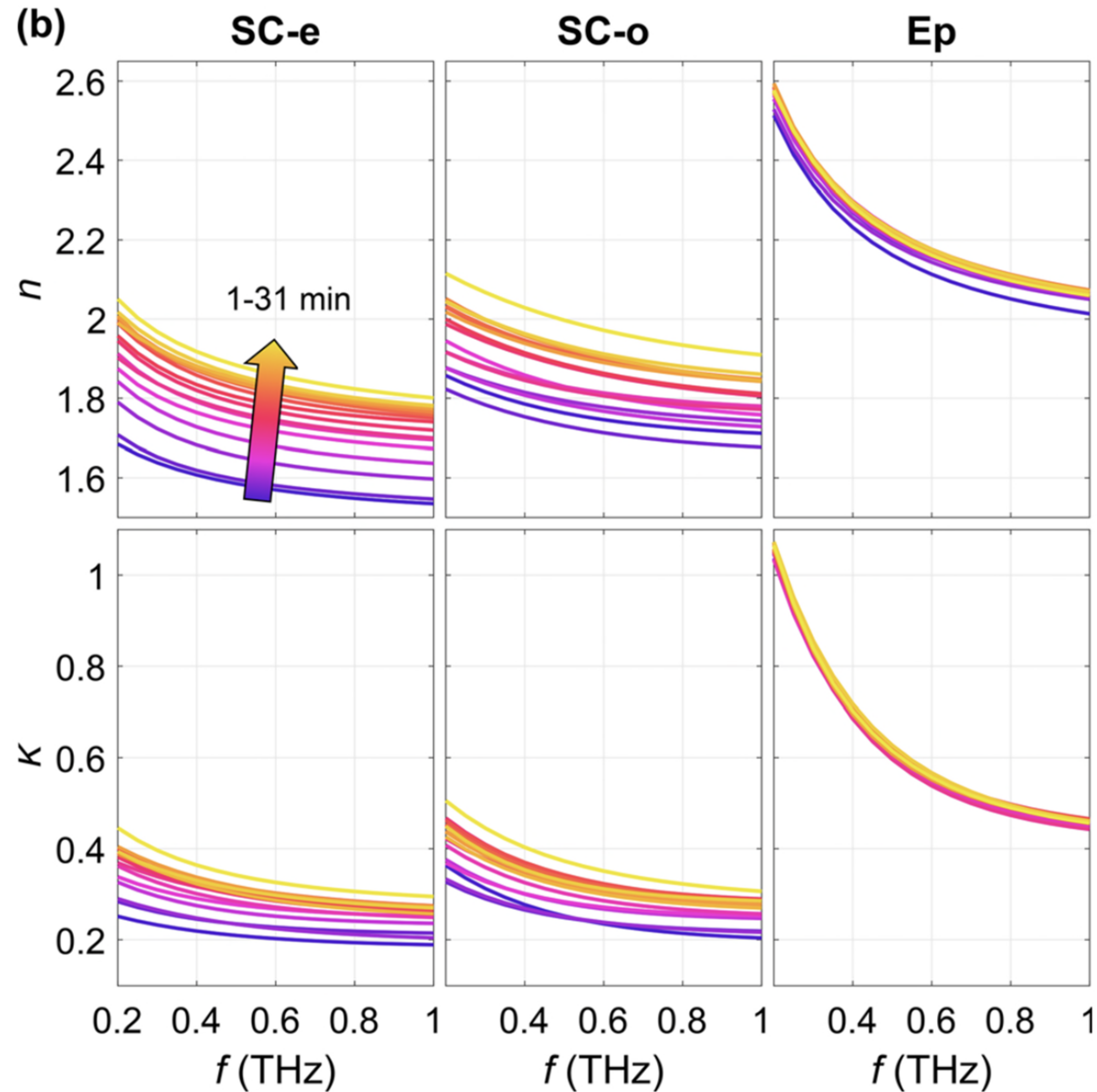

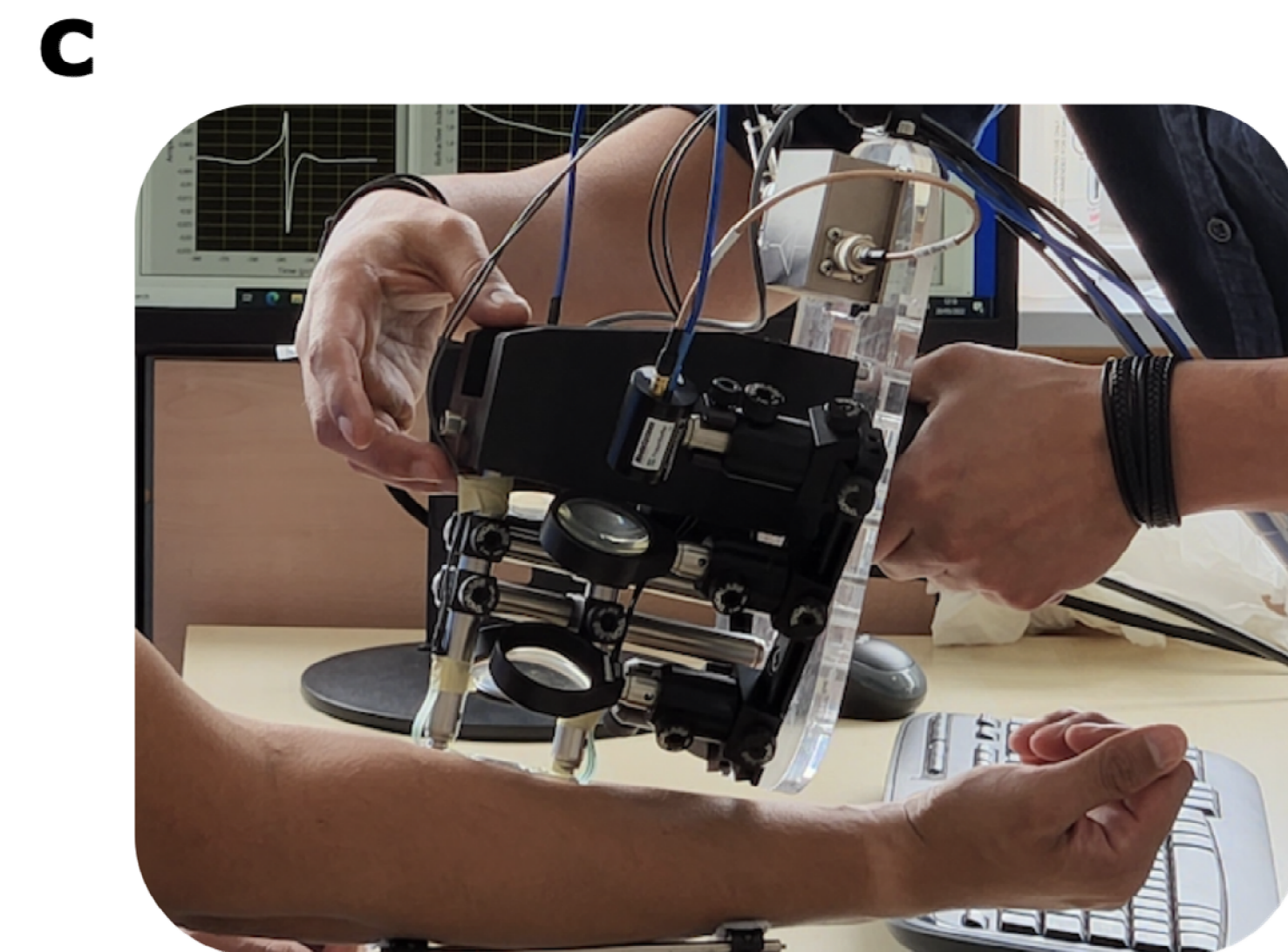
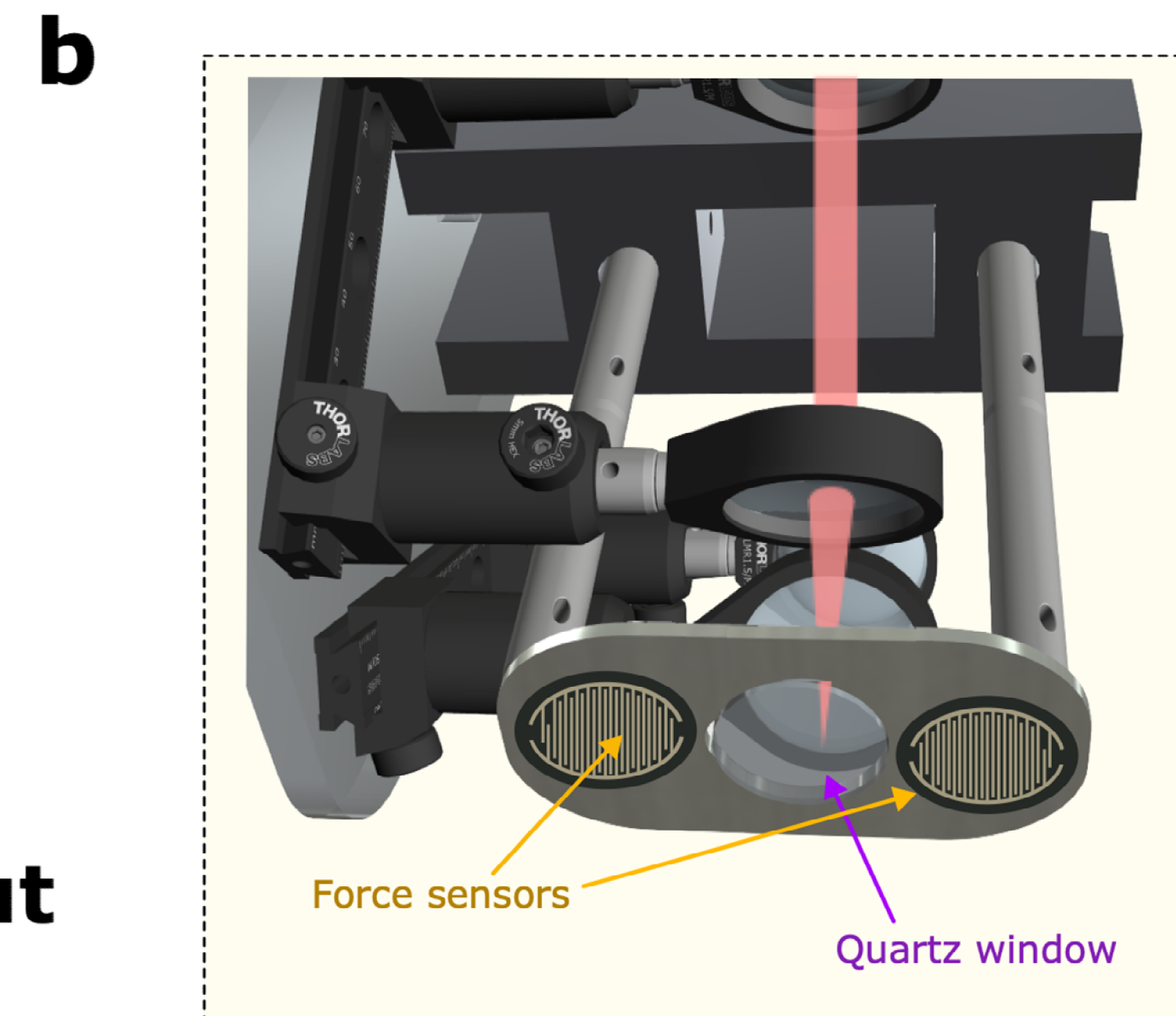
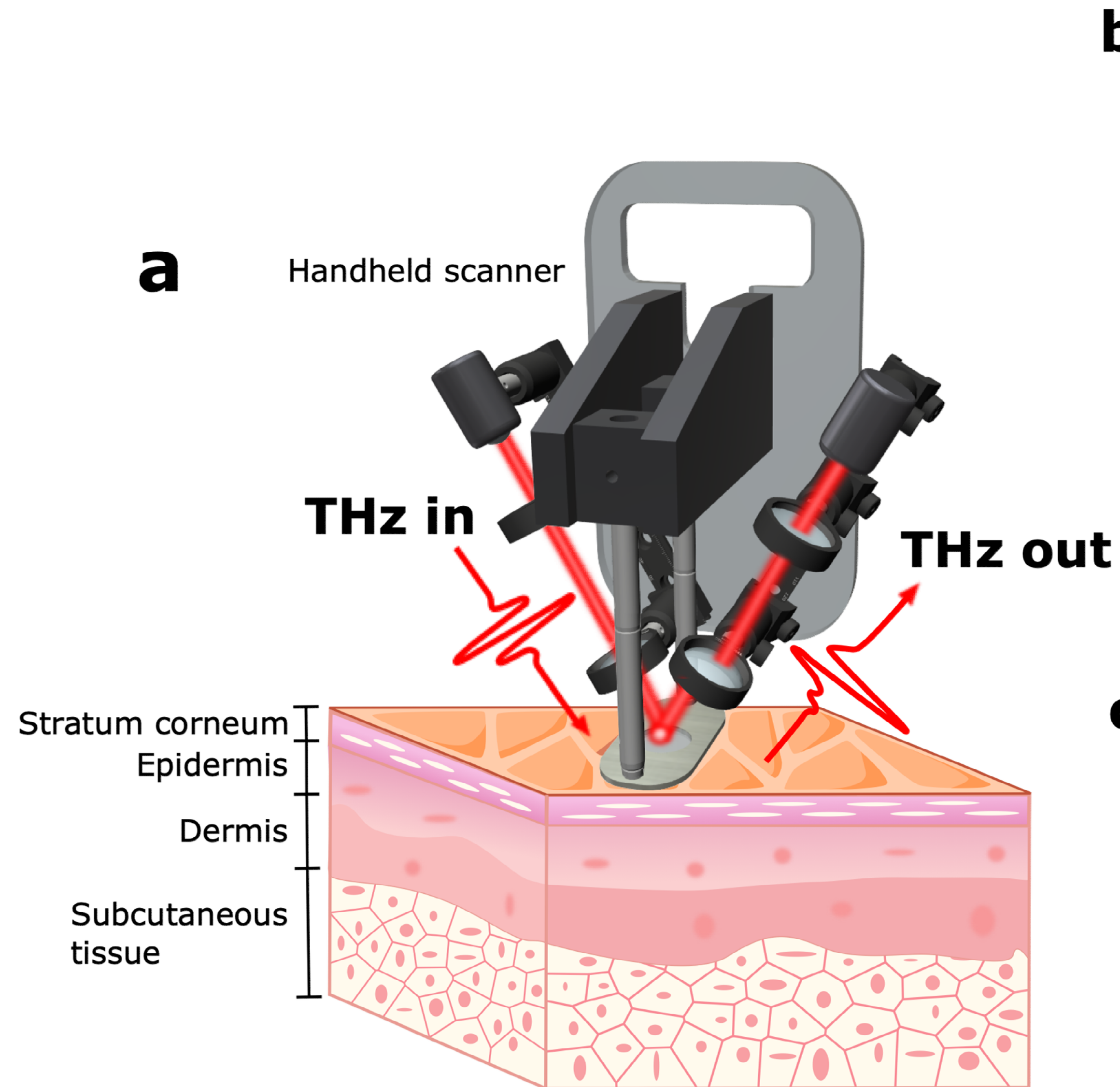

A large study



Experimental occlusion

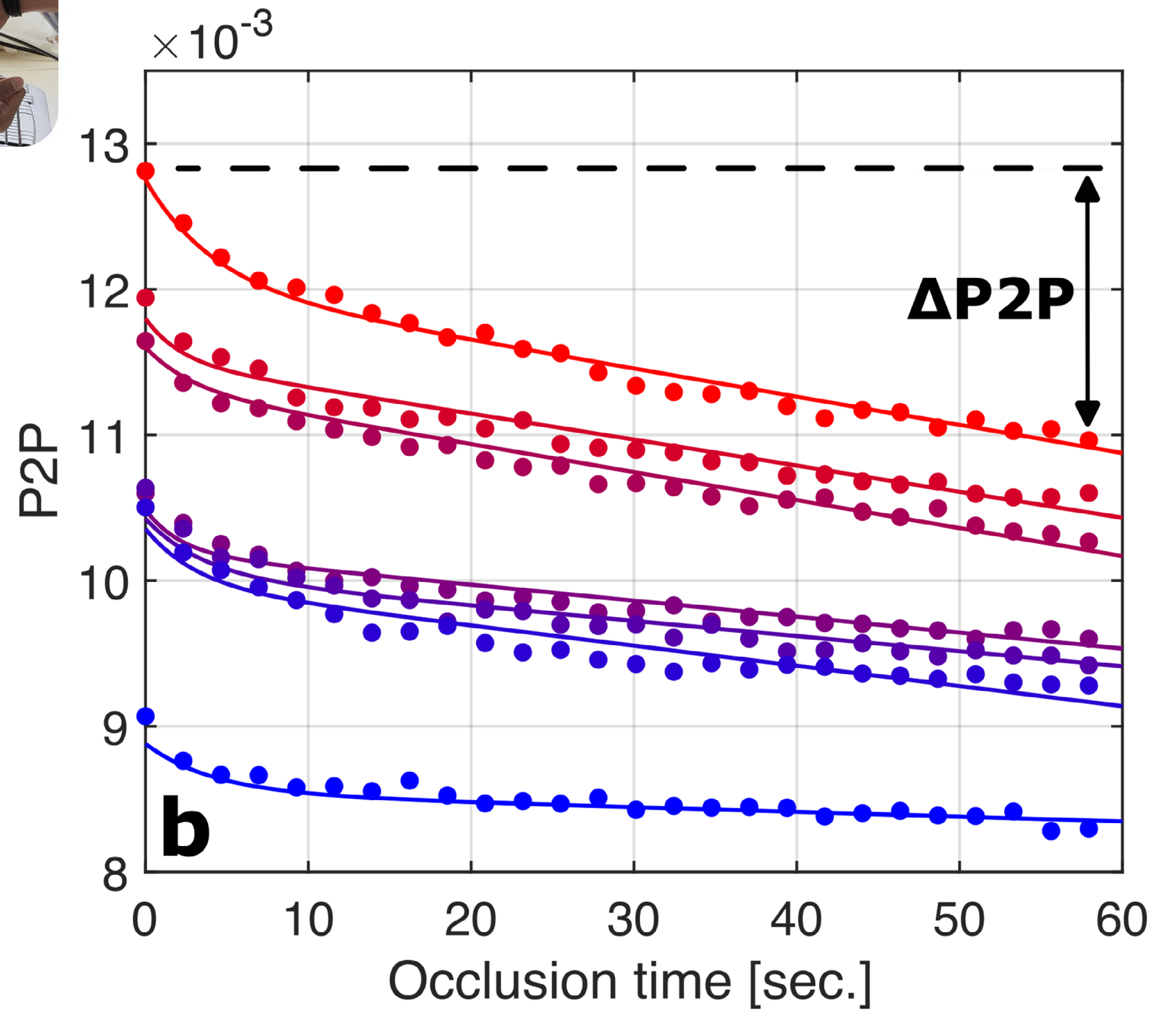
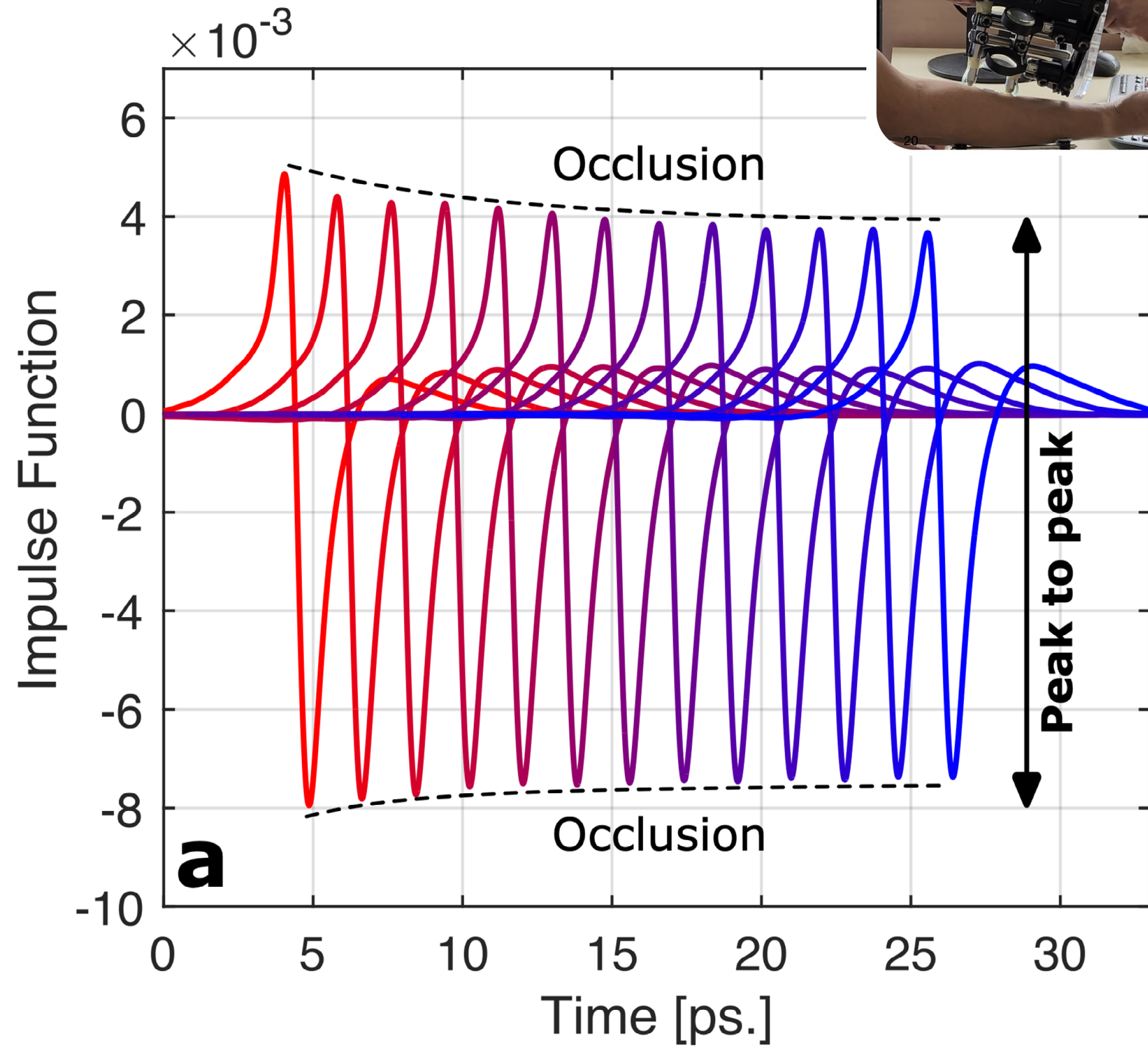
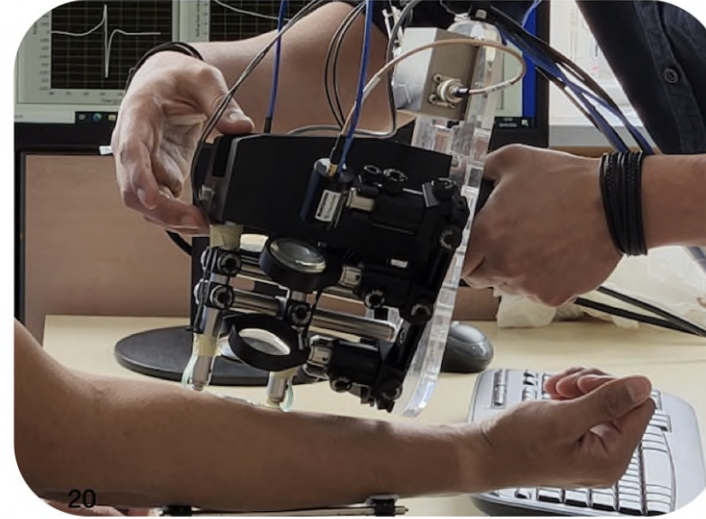

Experimental verification

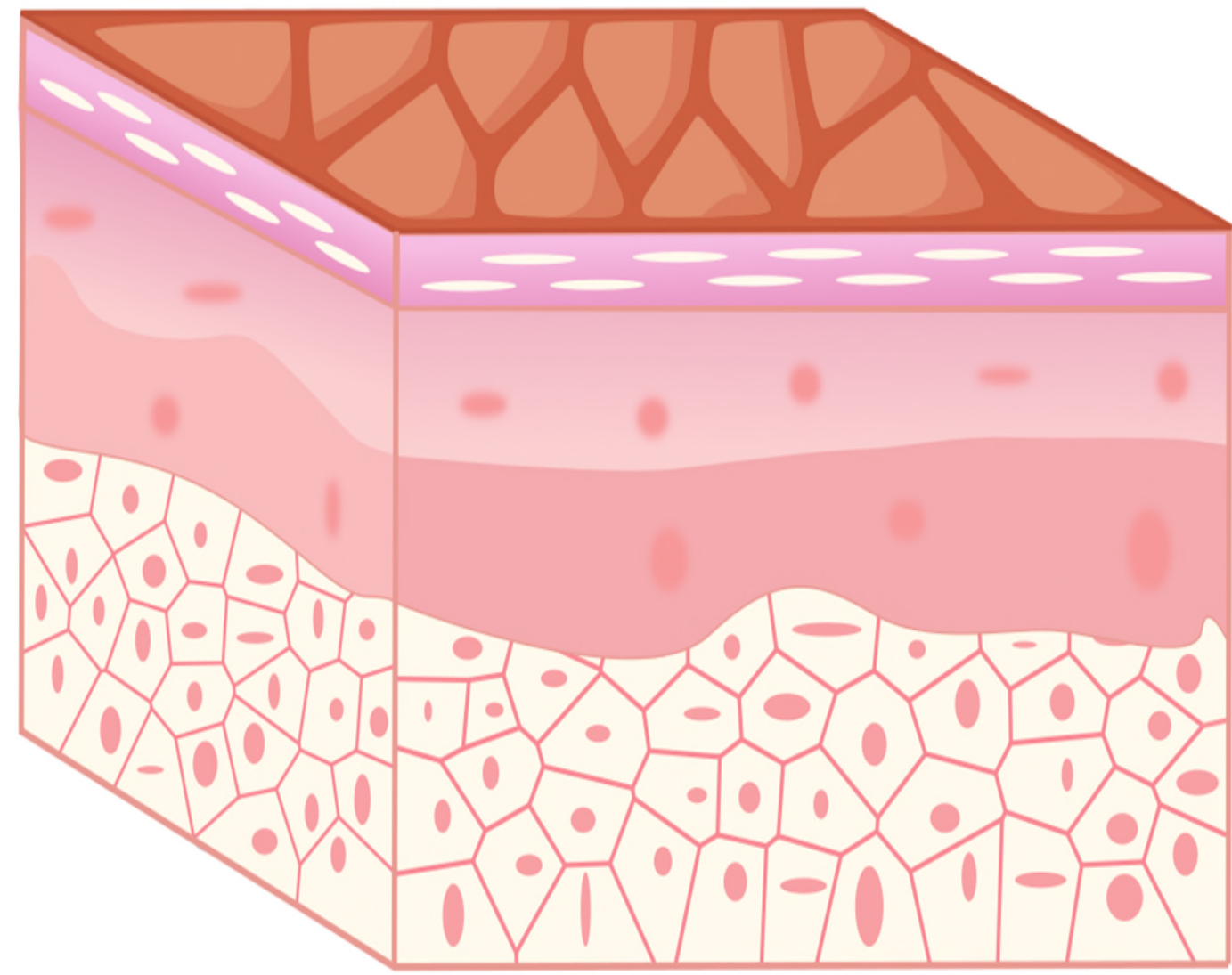
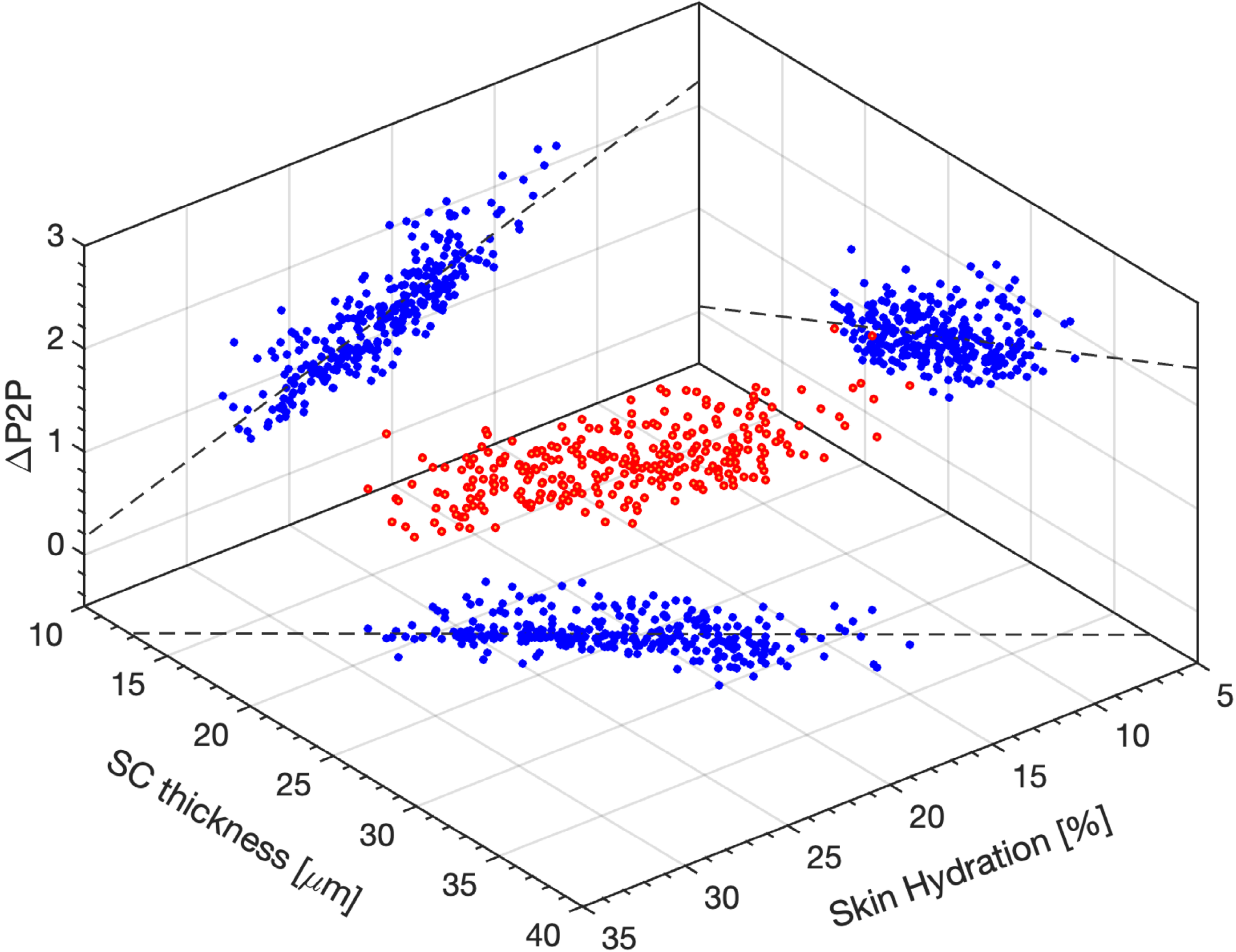

Transdermal patches

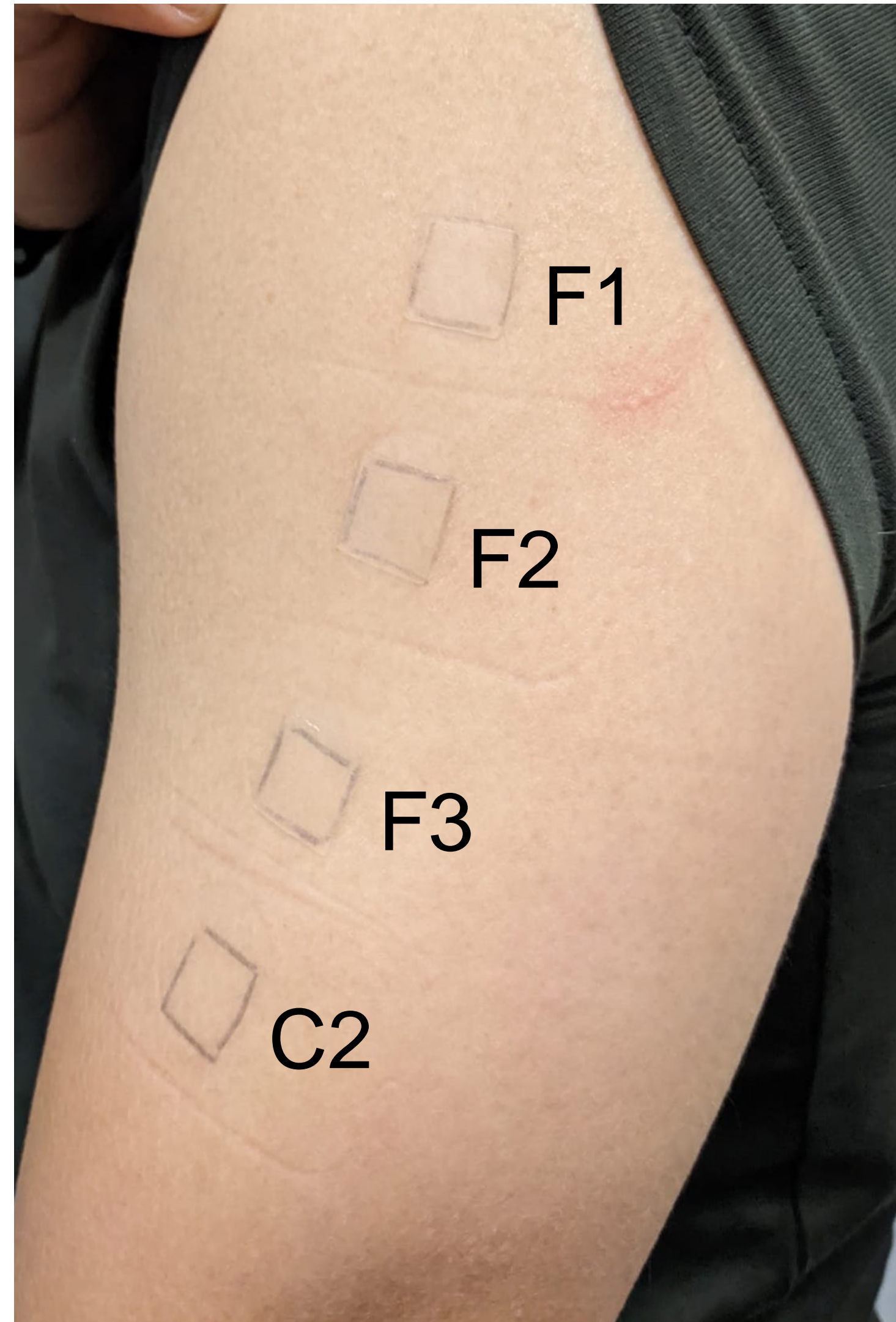
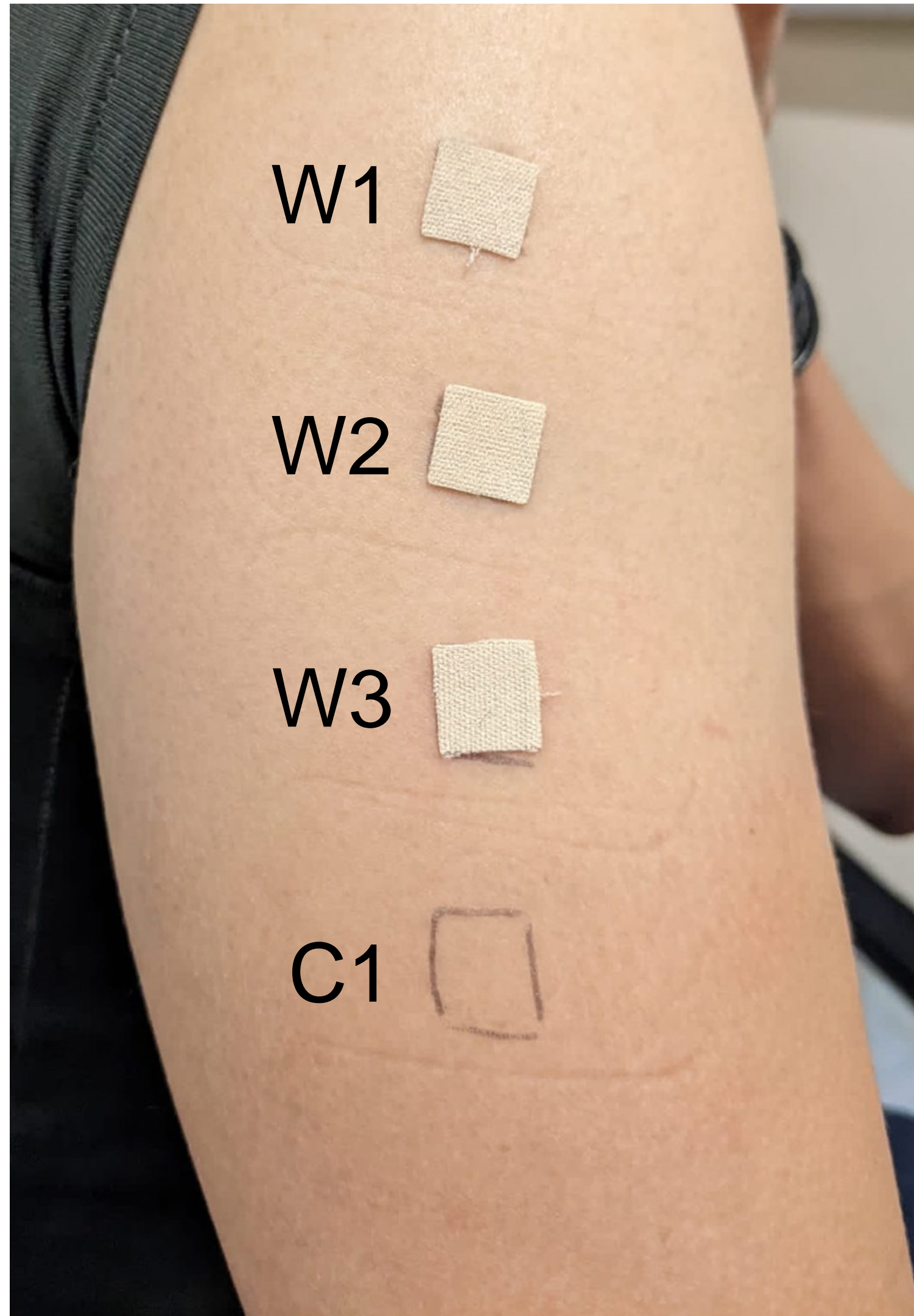

Drug delivery
Transdermal
Patches

Transdermal patches

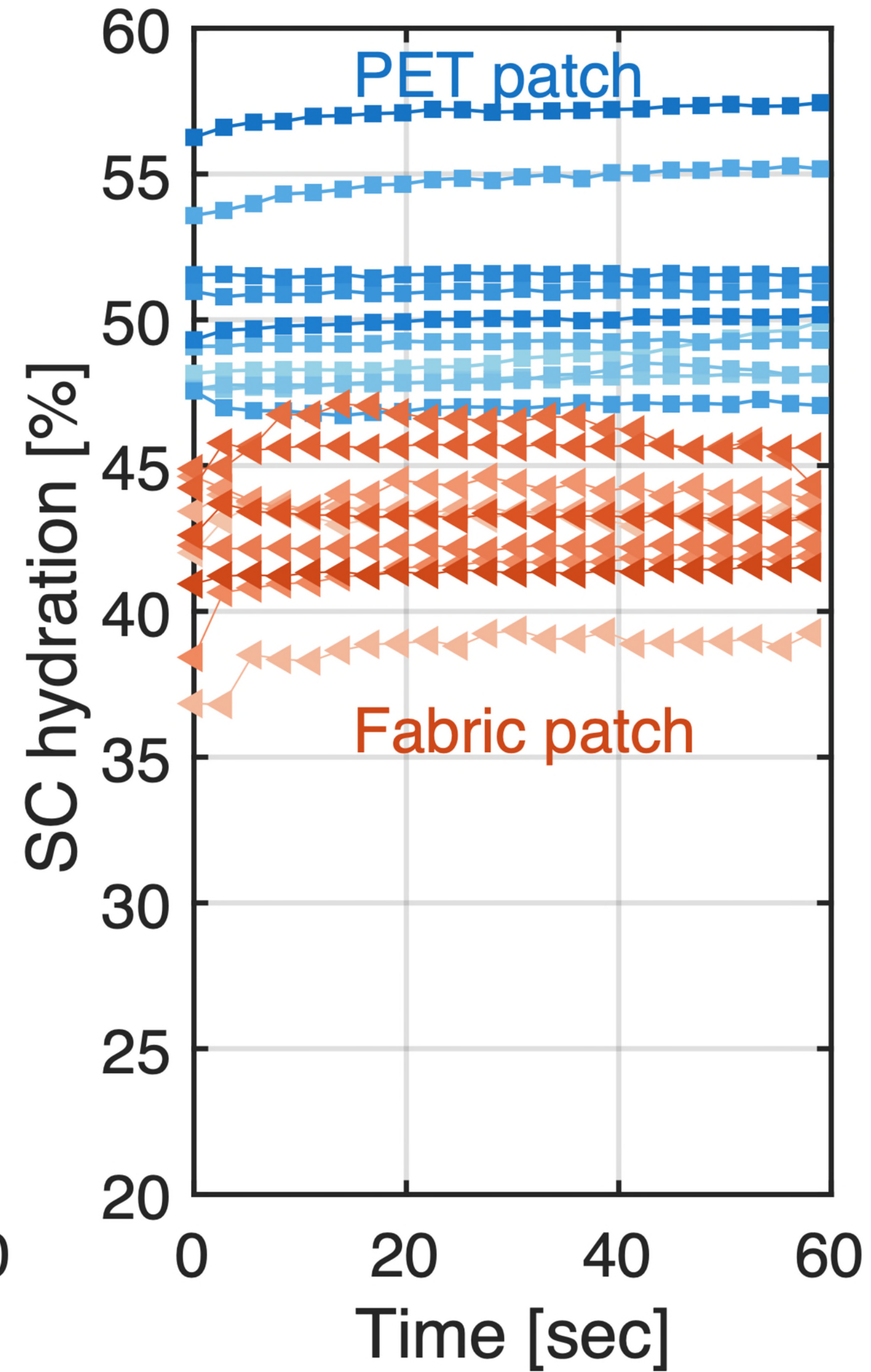
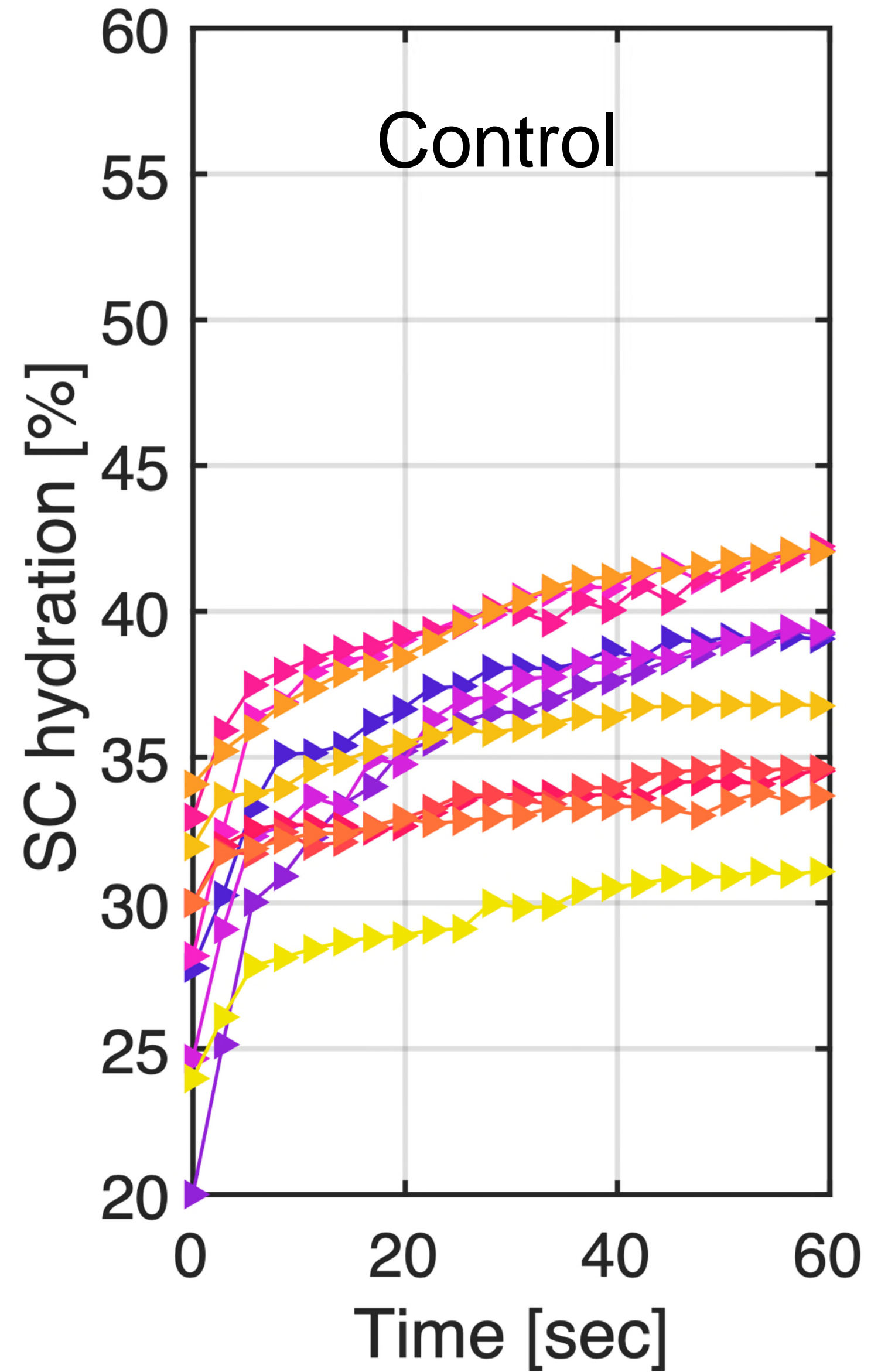

Terahertz-Time-Domain-Spectrometer

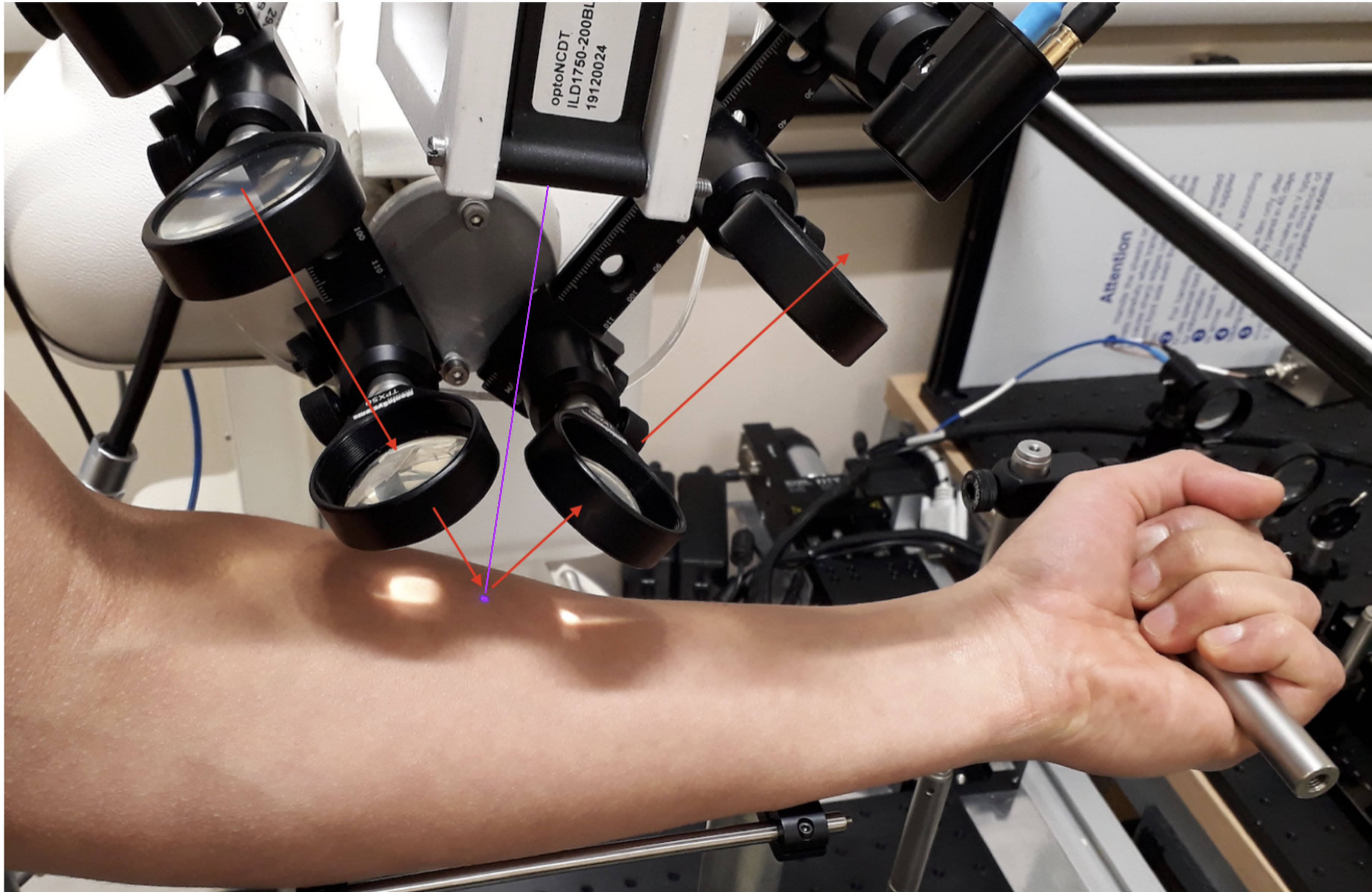

Real-time-Terahertz-Time-Domain-Spectrometer

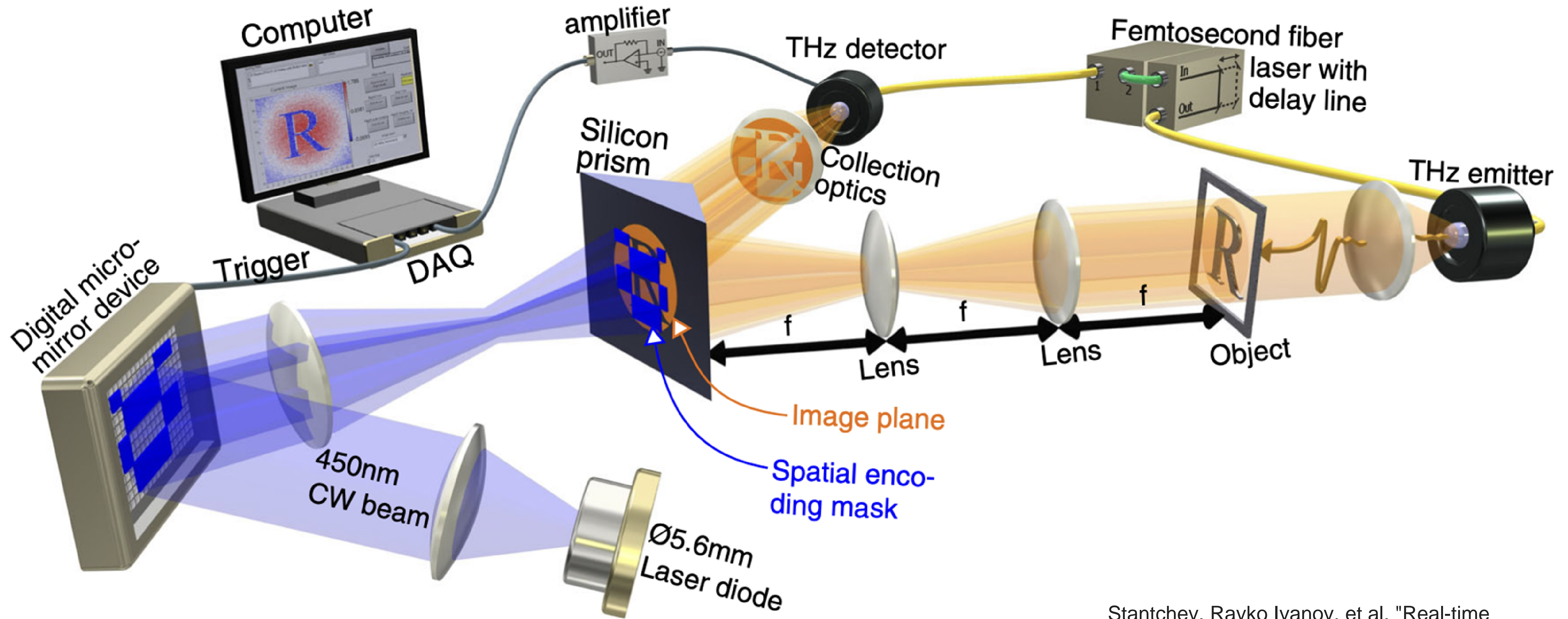

Stantchev, Rayko Ivanov, et al. "Real-time terahertz imaging with a single-pixel detector." *Nature communications* 11.1 (2020): 2535.

Real-time-Terahertz-Time-Domain-Spectrometer

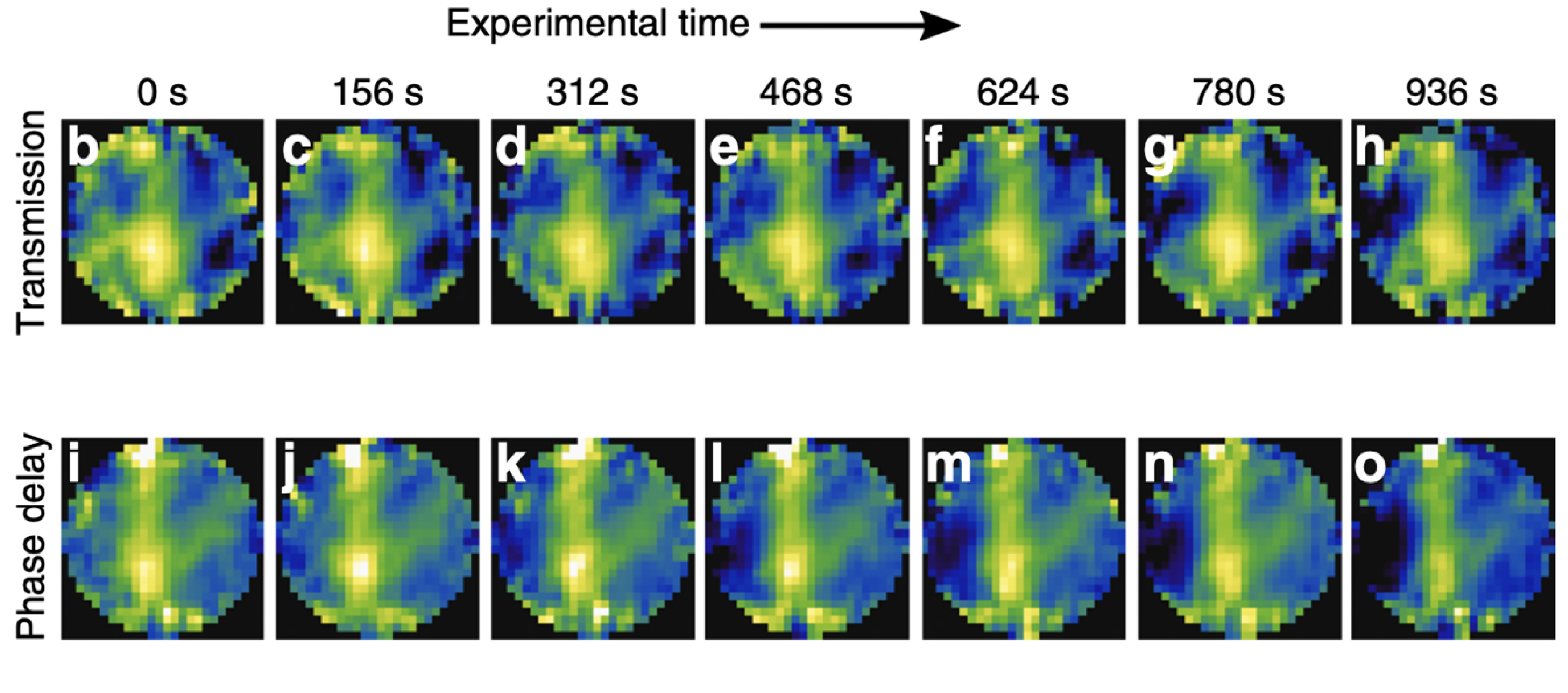
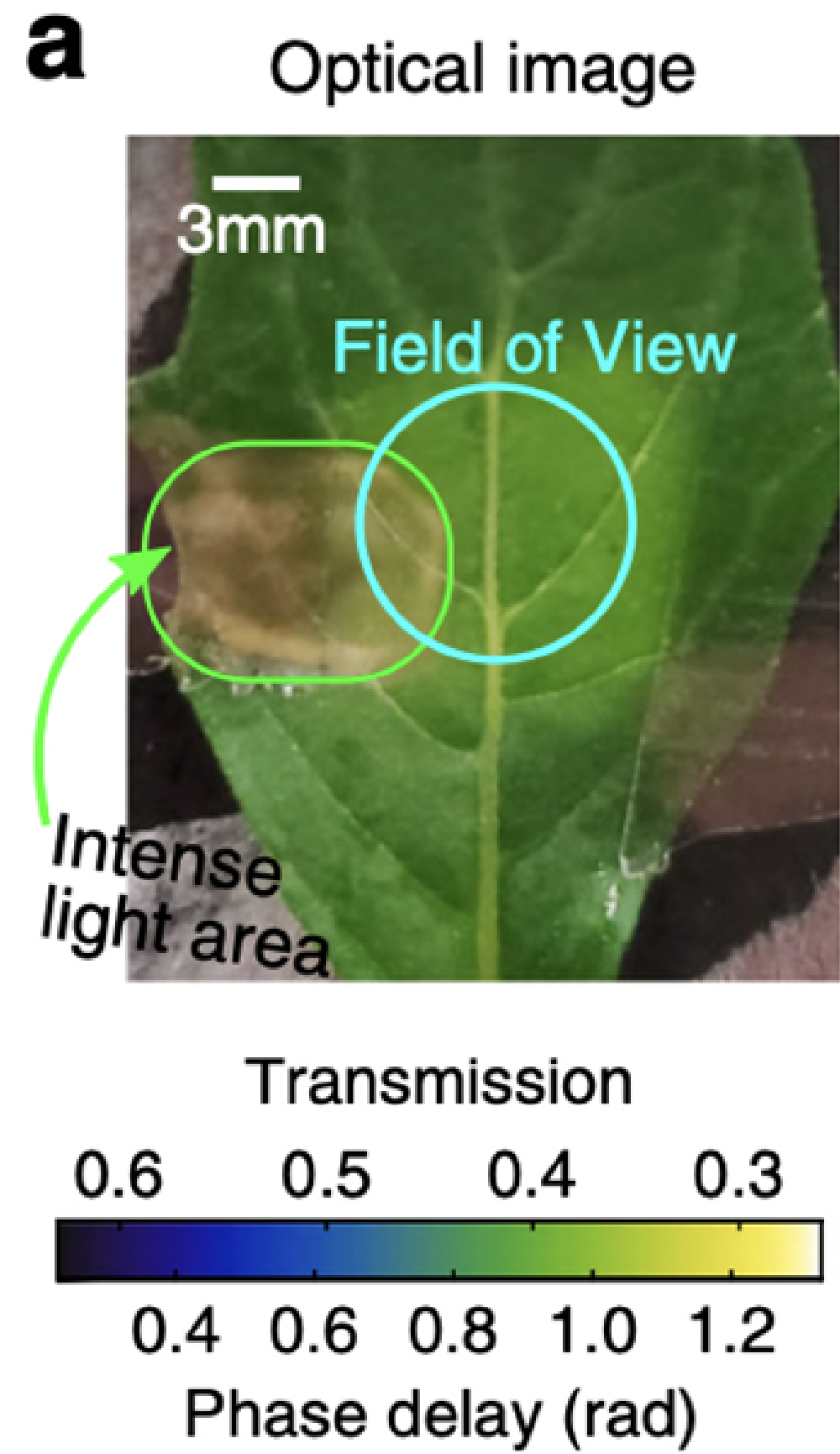

Stantchev, Rayko Ivanov, et al. "Real-time terahertz imaging with a single-pixel detector." *Nature communications* 11.1 (2020): 2535.

Media coverage

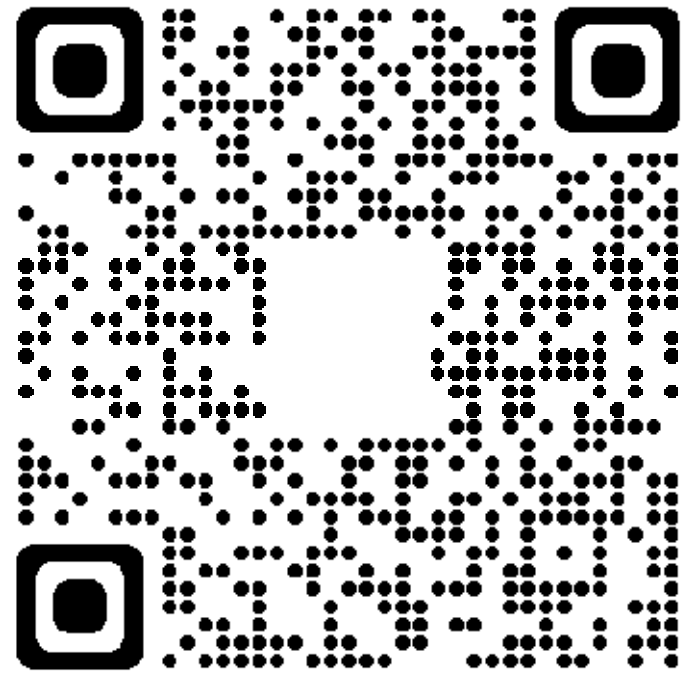

Thank you!

Questions?

Dr. Arturo Ignacio Hernandez Serrano
Research fellow
Arturo.Hernandez-Serrano@warwick.ac.uk

Emma MacPherson Terahertz Group

